



**THIRD UNITED NATIONS
REGIONAL
CARTOGRAPHIC CONFERENCE
FOR ASIA AND THE FAR EAST**

27 October — 10 November 1961, Bangkok, Thailand

**Vol. 2. Proceedings of the Conference
and Technical Papers**

UNITED NATIONS

Department of Economic and Social Affairs



**THIRD UNITED NATIONS
REGIONAL
CARTOGRAPHIC CONFERENCE
FOR ASIA AND THE FAR EAST**

27 October — 10 November 1961, Bangkok, Thailand

**Vol. 2. Proceedings of the Conference
and Technical Papers**

UNITED NATIONS

New York, 1965

HOW TO OBTAIN UNITED NATIONS PUBLICATIONS

United Nations publications may be obtained from bookstores and distributors throughout the world. Consult your bookstore or write to: United Nations, Sales Section, New York or Geneva.

COMMENT SE PROCURER LES PUBLICATIONS DES NATIONS UNIES

Les publications des Nations Unies sont en vente dans les librairies et les agences dépositaires du monde entier. Informez-vous auprès de votre librairie ou adressez-vous à: Nations Unies, Section des ventes, New York ou Genève.

COMO CONSEGUIR PUBLICACIONES DE LAS NACIONES UNIDAS

Las publicaciones de las Naciones Unidas están en venta en librerías y casas distribuidoras en todas partes del mundo. Consulte a su librero o diríjase a: Naciones Unidas, Sección de Ventas, Nueva York o Ginebra.

FOREWORD

The official records of the Third United Nations Regional Cartographic Conference for Asia and the Far East, held in Bangkok, Thailand, from 27 October to 10 November 1961, are issued, as were those of the two previous Conferences, in two volumes: Volume 1, *Report of the Conference*,¹ and the present publication, Volume 2, *Proceedings of the Conference and Technical Papers*.

This volume is in two parts: Part I contains the summary records of eight plenary meetings, Part II the texts of the technical and information papers submitted to the Conference by the participating Governments and by the Secretariat of the United Nations.

These technical papers are grouped according to the item of the agenda to which they relate. They have been edited in accordance with United Nations practices and requirements.

The designations employed and the presentation of the material in this publication do not imply the expression of any opinion whatsoever on the part of the Secretariat of the United Nations concerning the legal status of any country or territory or of its authorities, or concerning the delimitation of its frontiers.

¹ *Third United Nations Regional Cartographic Conference for Asia and the Far East, volume 1, Report of the Conference*, E/CONF.36/2 (Sales No : 62.1.14).

TABLE OF CONTENTS

Part I. Proceedings of the Conference

	<i>Page</i>
Summary record of first plenary meeting	3
Summary record of second plenary meeting	5
Summary record of third plenary meeting	8
Summary record of fourth plenary meeting	13
Summary record of fifth plenary meeting	15
Summary record of sixth plenary meeting	16
Summary record of seventh plenary meeting	17
Summary record of eighth plenary meeting	19

Part II. Technical papers presented to the Conference¹

<i>Agenda item 6.</i> Progress reports by countries on their respective cartographic activities since the last Conference	
Cartography in Afghanistan, submitted by Afghanistan	23
Report on cartographic activities in Australia, submitted by Australia	24
Khmer geographical service, submitted by Cambodia	25
Report on cartographic activities of the Ceylon Survey Department, submitted by Ceylon	30
Progress of cartographic work in China, submitted by China	30
Report on cartographic work in the Federal Republic of Germany, submitted by the Federal Republic of Germany	35
Report on the cartographic activities in India for the period 1958-1961, submitted by India	35
Geodetic work in Iraq, submitted by Iraq	40
Report on geodetic works, cartography, reproduction and cadastral survey carried out by Survey of Israel during the years 1958-1961, submitted by Israel	41
Report of cartographic works in Japan for the period from 1958 to 1960, submitted by Japan	43
Report on the cartographic activities of Laos, submitted by Laos	50
Report on the cartographic activities of Morocco, submitted by Morocco	51
Status of cartographic activities in the Philippines, submitted by the Philippines	52
Progress of Korean mapping, submitted by the Republic of Korea	55
Report on progress on cartographic projects in Saudi Arabia, submitted by Saudi Arabia	57
Report on aerial photographic activity in Saudi Arabia, submitted by Saudi Arabia	61
Brief report of cartographic activities in Sweden, submitted by Sweden	64
Report on cartographic activities in Switzerland, submitted by Switzerland	65
Progress reports on cartographic activities in Thailand, submitted by Thailand	66
United Kingdom progress report, submitted by the United Kingdom	68
Progress report of cartographic activities by the United States of America, October 1958 to October 1961, submitted by the United States of America	74
<i>Agenda item 7.</i> Reports on progress in matters which formed the basis of the resolutions or recommendations at the last Conference	
Comments on resolutions adopted at the Second United Nations Regional Cartographic Conference for Asia and the Far East, Tokyo, Japan, 20 October-1 November 1958, submitted by the United States of America	82

¹ Including only documents presented under substantive items 6 to 18 of the agenda, reproduced in this volume and arranged in the following manner: (1) by item or sub-item; (2) by country in alphabetical order; (3) in cases where more than one document was presented under a single item by the same country, by document symbol in numerical sequence. See volume I, *Report of the Conference*, E/CONF.36/2 (Sales No.: 62.114), page 6, for a complete list of agenda items, and pages 19 to 21 for a complete list of documents issued for the Conference.

A paper submitted by the United States of America entitled "Use of near-earth satellite orbits for geodetic information" has been omitted from this volume as it has been published by the United States Department of Commerce and may be obtained from the United States Government Printing Office, Washington 25, D.C.

TABLE OF CONTENTS (continued)

	<i>Page</i>
<i>Agenda item 8.</i> Establishment of a regional inter-governmental cartographic organization	
Proposal submitted by Thailand	85
<i>Agenda item 9.</i> Establishment of a regional training centre for surveying and mapping	
Proposal submitted by China	86
Proposal submitted by India	86
Proposal submitted by Thailand	87
<i>Agenda item 10.</i> Geodesy	
(a) Review of new techniques and developments	
World coverage by satellite geodesy, submitted by Japan	88
Investigation of the air-borne profile recorder, submitted by the United States of America	88
Portable surveying tower, submitted by the United States of America	91
Flashing signal lamp, submitted by the United States of America	93
Use of tellurometer for calibration of electronic navigation aids, submitted by the United States of America	94
Tellurometer for control survey, submitted by the United States of America	94
Measurement of small movements in the earth's crust, submitted by the United States of America	94
The isoparametric method of mapping one ellipsoid on another, submitted by the United States of America	100
Application of small electronic computers to geodetic survey computation, submitted by the United States of America	104
Electronic computation in surveying and mapping, submitted by the United States of America	106
Is the sea level falling or the land rising in south-east Alaska?, submitted by the United States of America	109
Establishment of tide gauges preparatory to the development of national geodetic control networks, submitted by the United States of America	112
(c) International connexion of geodetic co-ordinates	
Proposal by Australia	113
Background paper submitted by Thailand	113
(d) Establishment of standard base lines for calibrating radio-electronic or electromagnetic distance measuring instruments	
Technical paper submitted by Japan	114
<i>Agenda item 11.</i> Magnetic surveys and world magnetic charts	
Japanese programme of the World Magnetic Survey, 1960-1965, submitted by Japan	115
Geomagnetic surveys on sea by aircraft and ship, submitted by Japan	115
Background paper submitted by the United States of America	125
<i>Agenda item 12.</i> Hydrography and oceanography	
(a) Review of new techniques and developments	
Activities of the Hydrographic Office of Japan, 1958-1961, submitted by Japan	126
Report on progress in hydrographic surveying in Thailand, submitted by Thailand	137
Hi-Fix; D. M. Raydist; Echo sounding instruments; Telemetered tide information; Precision depth recorder, Mark V; Precision graphic recorder; Sound velocimeter system, and Sound velocity studies, submitted by the United States of America	141
Planning and development of small-craft charts, submitted by the United States of America	145
A new World Chart, submitted by the United States of America	148
Photogrammetric surveys for the production and maintenance of nautical charts, submitted by the United States of America	148
(b) Chart format and symbolization	
Nautical chart symbols and abbreviations, submitted by the United States of America	149
(c) Promotion of precise soundings for shallow waters and continental shelves	
Background paper submitted by Japan	149
A note on depth when the bottom is soft mud, submitted by Japan	150

TABLE OF CONTENTS (continued)

	<i>Page</i>
Background paper submitted by thitte United States of America	152
(d) Study of the representation of coastlines appearing in various charts and maps	
Background paper submitted by Japan	155
The representation of coastlines on nautical charts, submitted by the United States of America	155
<i>Agenda item 13. Topography and photogrammetry</i>	
(a) Review of new techniques and developments	
Automation in cartography, submitted by the Federal Republic of Germany	158
The aerial mosaic—a valuable photogrammetric aid, submitted by the Federal Republic of Germany	164
Scribing application at the Geographical Survey Institute of Japan, submitted by Japan	167
The present position of analytical photogrammetry, submitted by the Netherlands	169
Consideration of recommendations of the United Nations Seminar on Aerial Survey Methods and Equipment, submitted by the United States of America	175
Tellurometer operations in topographic mapping, submitted by the United States of America	176
The Army Map Service M-2 Stereoplotter; Automatic type placement system; The elevation meter in topographic mapping; Contrast control for diapositives; New sales edition of Topographic Instructions, and Single-prism stereoscope, submitted by the United States of America	178
Report on scribing, submitted by the United States of America	191
The 1960 Orthophotoscope, submitted by the United States of America	213
Analytic relative orientation in photogrammetry; Report on analytic aerotriangulation, and Vertical aerial triangulation block adjustments, submitted by the United States of America	216
(b) International standardization of map scales, format, accuracy classification and map symbols	
Comparison of Standard Cartographic Practices for Land Maps (SCP) and the specifications for Japanese topographic maps, submitted by Japan	231
(c) Co-operation in mapping of frontier areas	
Proposal submitted by Thailand	235
(d) Organization and operation of a national map information office	
The function of a national map information office, submitted by the United States of America	236
<i>Agenda item 14. Photo-interpretation</i>	
(a) Review of new techniques and developments	
Land use and forest resource survey in Taiwan, submitted by China	238
Limitations on the application of photo-interpretation, submitted by Thailand	240
Topical interpretation from aerial photographs, submitted by Thailand	241
Basic techniques used in photo-interpretation and sampling, submitted by Thailand	241
Photogrammetric surveys for nautical charting—use of colour and infra-red photography; Preliminary report on the use of aerial photographs in forest inventories; Air photo analysis in land utilization research, and Application of aerial photography to the economic analysis of land use for urban planning, submitted by the United States of America	242
Application of aerial photographs and regression techniques for surveying the Caspian forests of Iran; Some recent developments of basic significance for photo-interpretation, and Investigations in the use of colour photography for geologic purposes, submitted by the United States of America	256
(b) Exchange of interpretation key and material among regions lying on the same climatic belts and zones	
Exchange of interpretation key among regions lying on the same climatic belts and zones, submitted by Thailand	275
Exchange of materials and relevant information among regions lying on the same climatic belts and zones, submitted by Thailand	275
<i>Agenda item 15. Topical maps</i>	
(a) Review of new techniques and developments	
Topical maps and national atlases, submitted by China	277

TABLE OF CONTENTS (continued)

	<i>Page</i>
Methods of preparation and production of topical maps, submitted by Thailand	277
Types and scales of topical maps, submitted by Thailand	282
Review of reports of the Working Groups on Geology, Soils and Hydrology of the Committee on Special Maps, Commission on Cartography, Pan American Institute of Geography and History, submitted by the United States of America	283
(b) Small-scale base maps (scales 1:250,000 to 1:5,000,000) for use in preparing topical maps	
Prospective considerations on smaller scales, submitted by the Federal Republic of Germany	287
Some typical examples of small-scale base maps (1:250,000-1:12,000,000) for special purpose mapping, submitted by the United States of America	287
(c) Projection system, conventional signs, legends and romanization for topical maps	
Conventional signs, legends and romanization, submitted by Thailand	289
Regional projection system for topical maps, submitted by Thailand	289
(d) Regional atlas	
Establishment of a central organization for compiling and printing a regional economic atlas for Asia, submitted by Thailand	292
Compilation of a regional stereoscopic and anaglyphic atlas, submitted by Thailand	294
<i>Agenda item 16. Aeronautical charts</i>	
Recent developments in cartographic methods and techniques; Photogrammetric surveys for aeronautical charting; Effect of stratified airspace systems on aeronautical charting, and Cartographic development at scale 1:1,000,000, submitted by the United States of America	295
Progress made in international standardization of aeronautical charts and flight information publications, submitted by the United States of America	302
Aviation's challenge to aeronautical cartography, submitted by the United States of America	303
<i>Agenda item 17. Specifications of the International Map of the World on the Millionth Scale (IMW)</i>	
Tentative specifications for international 1:1,000,000 general maps of China, submitted by China	304
Views on sheet line and projection systems for IMW and WAC series, submitted by Japan	310
Specifications for the IMW series, submitted by Thailand	310
<i>Agenda item 18. Geographical names</i>	
Recent developments in international standardization of geographic names: progress between the Second and Third Regional Cartographic Conferences for Asia and the Far East, submitted by the United States of America	312

LIST OF ILLUSTRATIONS¹

<i>Figure</i>	<i>Page</i>
1. Australia: National geodetic survey as at 1 September 1961	26
2. Australia and New Guinea: Air photography coverage as at 1 September 1961	26
3. Australia and New Guinea: Map coverage as at 1 September 1961	27
4. Australia and New Guinea: Geological mapping	27
5. Australia and New Guinea: Surveys by the Commonwealth Scientific and Industrial Research Organization	28
6. Australia and New Guinea: Forestry and timber surveys as at 1 September 1961	28
7. Cambodia: Area covered by aerial photographs on the scale 1:10,000, 1958-1959 mission	31
8. Cambodia: Area covered by aerial photographs on the scale 1:40,000, 1957-1958 mission	31
9. Map of Cambodia on the scale 1:50,000 now being compiled	32
10. Index map of the Map of Cambodia on the scale 1:100,000	32
11. Map of Cambodia on the scale 1:400,000	33
12. Index map of the Map of Cambodia on the scale 1:250,000	33
13. Saudi Arabia: Status map of the 1:500,000 geological map project	62
14. Saudi Arabia: Status map of the 1:500,000 geographic map project	62
15. Persian Gulf: Location of trilateration base stations	63
16. Persian Gulf: Illustration of mean low-water line	63
17. Investigation of Air-borne Profile Recorder: Flight line layout	89
18. Aircraft equipped with Air-borne Profile Recorder	90
19. Comparison of radar profile with profile of terrain	90
20. Portable surveying tower being towed as a trailer	92
21. Erecting portable surveying tower	92
22. Portable surveying tower being transported by helicopter	92
23. Fieldmen using theodolite on portable tower	92
24. Flashing signal lamp	93
25. Flasher circuit diagram	93
26. General location chart of earth movement projects	97
27. Horizontal movement of earth's crust between 1932 and 1959, vicinity of Buena Vista Hills, California	98
28. Japan: Plan of the aerial geomagnetic survey for the world magnetic charts	116
29. Schematic diagram of operation of the saturable inductor of the air-borne magnetometer	118
30. <i>B-H</i> curves of the ferromagnetic core of the saturable inductor of the air-borne magnetometer	118
31. Schematic diagram of the air-borne magnetometer	119
32. Flight pattern of aeromagnetic survey	119
33. Results of the aeromagnetic survey in the Izu Syoto area	120
34. Schematic diagram of operation of the saturable inductor of the ship-borne magnetometer	120
35. Schematic diagram of the ship-borne magnetometer	121
36. Distribution of measuring points of magnetic survey	121
37. Magnetic anomalies and submarine topography	122
38. Distribution of a magnetic anomaly due to an underground dipole	122
39. Theoretical distribution of the vertical magnetic field of a steel vessel	123
40. Relation between the magnetic field of the Takuyo and depth	124
41. Chart of oceanographic observations of the seas adjacent to Japan—I	128
42. Chart of oceanographic observations of the seas adjacent to Japan—II	129

¹ Except for certain titles and legends, the maps appearing in this volume have been reproduced from the papers submitted by Governments without alteration.

List of Illustrations (continued)

<i>Figure</i>	<i>Page</i>
43. Topography of Komahasi seamounts	130
44. Main seamounts and shoals discovered in the seas adjacent to Japan	132
45. Japan: Publishing plan of coastal charts at 1:200,000 scale (May 1961)	135
46. Diagram showing organization of the Maritime Safety Board and the Hydrographic Office of Japan	137
47. Third-order triangulation net covering the Bangkok area	138
48. Chao Phraya River, Thailand: Chart of hydrographic survey	139
49. Determination of sea bottom features: Comparison between lead sounding and echo sounding	151
50. Diagram showing insertion of electric store between plotting machine and camera	158
51. Diagram of projector for the differential reduction of distortion	159
52. The Graphomat: Diagram of working procedure	159
53. Photographs of the first model of the Graphomat compared with the latest model	160
54. Example of reduction of map scale by use of the Graphomat	161
55. Diagram of the automatic plotting equipment of the Zeiss Stereoplanigraph	161
56. The Co-ordimat	162
57. The profile computer	162
58. The Profiloscope	163
59. The Stereomat	163
60. The Klimsch Variomat	163
61. Examples of results obtained by using the Klimsch Variomat for reproducing features of terrain and lettering	163
62. Proposed type placement system—Plan A	182
63. Proposed type placement system—Plan B	184
64. Experimental operating system for testing image selection and display tubes	185
65. Automatic type placement system equipment	186
66. New model of the Johnson elevation meter	187
67. Schematic diagram of a 153/55 printer with electronic contrast control	188
68. Schematic diagram of 153/55 printer with phosphor-quenching contrast control	188
69. Comparison between undodged and dodged prints	189
70. Single-prism stereoscope with magnifying lens	191
71. Field use of stereoscope	191
72. Scribing instruments	197
73. Generalized flow diagram for colour separation scribing	199
74. Examples of scribing gravers used by the United States Geological Survey	201
75. Examples of other scribing instruments used by the United States Geological Survey	202
76. Device for sharpening graver points and methods of use—I	203
77. Device for sharpening graver points and methods of use—II	204
78. Device for sharpening graver points and methods of use—III	205
79. Register punch	206
80. Map symbol templates	207
81. Dot graver sharpened to a pyramid point	208
82. Flow diagram of basic colour separation procedure	209
83. The 1960 Orthophotoscope with ER-55 projectors	215
84. The 1960 Orthophotoscope with Kelsh-type projectors	215
85. Diagram showing the geometric relationships used in the basic projective transformation	218
86. Diagrams of the five tables	224
87. Diagrams of analytic aerotriangulation test for horizontal and vertical control	227
88. Datum and tilt error possibilities in a typical block of strips	228
89. Diagram of production project showing block adjusted area	229
90. Vertical block adjustment passpoint differences (in metres) before and after block adjustment	229
91. Relationship between the earth's surface and the instrument co-ordinate surface of a block of strips	230

List of illustrations (continued)

<i>Figure</i>		<i>Page</i>
92.	Bottom topography drawn from colour photographs by Kelsh plotter	243
93.	Sketch maps showing the difference in the hydrography of an area before and after the use of colour photography	244
94.	Aerial photography applied to urban land use inventory	252
95.	Aerial photography applied to urban land use analysis and planning	255
96.	Caspian Forest Survey Code Index Map of Regional Forests	257
97.	Three-dimensional model of a tree illustrating terms relating to photographic image quality	261
98.	Visual test chart used in the testing of photo-interpreters	264
99.	Sketch maps showing different degrees of effectiveness of colour photography in different types of map coverage	270
100.	Methods of colour measurement and their application to geologic study	272
101.	Photographs of image on display tube of image enhancement device	274
102.	Outline map of proposed interrelated regions having similar projections	290
103.	Example of Turbine Data Sheet issued by the United States Federal Aviation Agency . .	300
104.	Gradient tint diagram for international 1:1,000,000 general maps of China	305
105.	Map symbols for international 1:1,000,000 general maps of China	308

Part I

PROCEEDINGS OF THE CONFERENCE

SUMMARY RECORD OF FIRST PLENARY MEETING¹

Held at Sala Santitham, Bangkok, Thailand, on Friday, 27 October 1961, at 10.30 a.m.

CONTENTS

	<i>Page</i>
Address by H.R.H. Prince Wan Waithayakon, Deputy Prime Minister of Thailand	3
Statement by the Temporary Chairman	3
Vote of thanks to the Government of Thailand	4
Adoption of the rules of procedure (item 1 of the agenda)	4
Election of officers (item 2 of the agenda)	4

Temporary Chairman: Dr. Te-Lou TCHANG, Chief of the Cartographic Section of the Department of Economic and Social Affairs of the United Nations.

Present:

The representatives² of the following countries: Afghanistan, Australia, Cambodia, Canada, Ceylon, China, Federal Republic of Germany, Federation of Malaya, France, India, Iraq, Israel, Japan, Laos, Morocco, Netherlands, Philippines, Republic of Korea, Saudi Arabia, Sweden, Switzerland, Thailand, United Kingdom of Great Britain and Northern Ireland, United States of America.

The observer from Indonesia.

Observers from the following organizations: Food and Agriculture Organization of the United Nations, United Nations Educational, Scientific and Cultural Organization, International Civil Aviation Organization, International Hydrographic Bureau, European Organization for Experimental Photogrammetry Research, International Geographical Union, International Union of Geodesy and Geophysics.

Address by H.R.H. Prince Wan Waithayakon

H.R.H. PRINCE WAN WAITHAYAKON, Deputy Prime Minister of Thailand, extended a warm welcome to the participants of the Third United Nations Regional Cartographic Conference for Asia and the Far East, on his own behalf and on behalf of the Government of Thailand.

He pointed out that accurate maps are the prerequisite of any development programme, such as general economic development, development of world resources, land development, and so on.

He outlined the threefold purpose of the Conference. First, such a Conference would accelerate the mapping and surveying necessary for the development of individual countries. Secondly, it would help in the exchange of knowledge of newly developed techniques between the

cartographically advanced countries and the countries wanting to apply such knowledge to their own development projects. Finally, it would help to further friendship and understanding among the nations represented.

In conclusion, he offered his best wishes for the success of the Conference and expressed his hope that this exchange of technical knowledge would yield excellent results and would serve as a continuing link for future exchange of valuable knowledge on cartographic activity.

Statement by the Temporary Chairman

The TEMPORARY CHAIRMAN, speaking on behalf of the Secretary-General of the United Nations, extended a whole-hearted welcome to the participants and thanked the Government of Thailand for the excellent arrangements which had been made for the Conference.

He recalled that since the First United Nations Regional Cartographic Conference for Asia and the Far East, held at Mussoorie, India, in 1955, several countries in the region had made spectacular progress in developing national cartographic services as well as in achieving surveying and mapping work. In this, the United Nations had played a modest part through direct technical assistance in the form of providing experts, supplying materials and instruments, granting fellowships, organizing regional projects and through other activities, such as technical conferences, working parties, seminars, pilot courses and the like.

Moreover, the Economic and Social Council had, during this period, given constant attention to the promotion of international co-operation in the field of cartography and the Economic Commission for Asia and the Far East had made a substantive contribution in this domain by preparing and publishing several regional topical maps: the Geological Map, the Oil and Gas Map and the Mineral Map, among others. The Mekong and the Asian Highway projects included important basic and detailed surveying and mapping work in the region. In executing their programmes in the region, various United Nations specialized agencies had also contributed to the preparation of special subject maps in their respective fields.

In spite of all these achievements, he observed, the need for cartographic data was far from being fulfilled and cartographic activities had still to be extended. The subjects to be covered ranged from basic mapping to topical mapping. The latter was required for many economic and social projects, in particular in connexion with water and mineral resources development, communications and transport planning, rural and urban development and the like. The urgent need was, therefore, for techniques which could be adapted to these various activities in the region and for ensuring their use in a more efficient and economical manner. The emphasis had been not on making perfectly accurate maps for the whole

¹ Issued as E/CONF.36/SR.1.

² For a list of representatives and United Nations staff who attended all plenary meetings, see *Third United Nations Regional Cartographic Conference for Asia and the Far East*, vol. 1, *Report of the Conference* (Sales No.: 62.1.14), pages 1 to 4.

region but on making urgently needed maps with an accuracy suitable to practical requirements. Thus, the problem that confronted the countries of the region was not only to produce such maps but also to produce them more rapidly and at less cost.

In closing, the TEMPORARY CHAIRMAN invited the attention of the participants to the wide range of items contained in the provisional agenda. He personally believed that discussion of these items would prove to be very beneficial to the region since it would, on the one hand, facilitate a full scale exchange of information on various cartographic techniques and, on the other, enable the problems encountered by the countries of the region to be studied in the light of world-wide experience.

Vote of thanks to the Government of Thailand

Captain PALMA (Philippines) expressed his Government's thanks to the Government of Thailand for the excellent arrangements made for the Third United Nations Regional Cartographic Conference for Asia and the Far East. He proposed a vote of thanks to the Government of Thailand for its hospitality and for the excellent work it had done on the Conference.

Rear-Admiral KARO (United States of America) and Mr. PAOLINI (France) supported the resolution.

The resolution was unanimously adopted.

The meeting was adjourned at 11 a.m. and resumed at 11.35 a.m.

Adoption of the rules of procedure

[Item 1 of the agenda]

The TEMPORARY CHAIRMAN submitted to the Conference the draft rules of procedure.

Major-General BUSRINDRE (Thailand) proposed that the rules of procedure be adopted.

The rules of procedure were unanimously adopted.

Election of officers

[Item 2 of the agenda]

Mr. PHANARETH (Laos) nominated as President the Chairman of the Delegation of Thailand.

Major-General BUSRINDRE was elected President by acclamation and took the Chair.

The PRESIDENT thanked the Conference for the honour it had bestowed on his country in electing him. He promised that he would do his best in performing his task.

The PRESIDENT called for nominations for the two posts of Vice-President.

Mr. GREIG (Federation of Malaya) proposed as First Vice-President Captain Palma, Chairman of the Delegation of the Philippines. Mr. LUNDGREN (Sweden) seconded the nomination.

Captain PALMA was unanimously elected First Vice-President.

Colonel CHUMPHON KULKASEM (Thailand) proposed Colonel SINHA, Chairman of the Delegation of India, for the post of Second Vice-President.

Mr. SCHERMERHORN (Netherlands) seconded the nomination.

Colonel SINHA was unanimously elected Second Vice-President.

Mr. NAKANO (Japan) proposed Mr. DIAS, Delegate from Ceylon, for the post of Rapporteur.

Rear-Admiral KARO (United States of America) seconded the nomination.

Mr. DIAS was unanimously elected Rapporteur.

The PRESIDENT invited the Chiefs of Delegations to attend an informal meeting scheduled for the following morning.

The meeting rose at 12.5 p.m.

SUMMARY RECORD OF SECOND PLENARY MEETING¹

Held at Sala Santitham, Bangkok, Thailand, on Friday, 27 October 1961, at 2.30 p.m.

CONTENTS

	<i>Page</i>
Adoption of the agenda (item 3 of the agenda)	5
Report on credentials (item 4 of the agenda)	5
Establishment of technical committees (item 5 of the agenda)	5
Progress reports by countries on their respective cartographic activities since the last Conference (item 6 of the agenda)	5

Committee V: Magnetic surveys and world magnetic charts; hydrography and oceanography.

The PRESIDENT submitted for the approval of the Conference the establishment of the five technical committees as proposed by the informal meeting of the Chiefs of Delegations and asked that the Chairmen of the Committees be elected.

The Conference approved the five committees and elected the following Chairmen:

Committee I: Mr. G. R. L. Rimington (Australia);
Committee II: Colonel Chumphon Kulkasem (Thailand);
Committee III: Mr. A. L. M. Greig (Federation of Malaya);
Committee IV: Mr. Chansamone Voravong (Laos);
Committee V: Mr. Akira Sinzi (Japan).

President:

Major-General Busrindre BHAKDIKUL (Thailand)

Adoption of the agenda

[Item 3 of the agenda]

Dr. TCHANG (Executive Secretary) pointed out that the provisional agenda² contained twenty items, many of which had several sub-items. For most of the items and sub-items background papers or technical papers had been received. All the papers would be issued as documents and a list of these documents would soon be available.

The PRESIDENT invited the views of the Conference on the procedure to be followed in considering the provisional agenda. He added that the Conference could proceed either by an item-by-item discussion or by approval of the whole.

Mr. RIMINGTON (Australia) moved the adoption of the whole of the provisional agenda as prepared by the Secretariat. The motion was seconded by Rear-Admiral KARO (United States of America).

The agenda was adopted.

Progress reports by countries on their respective cartographic activities since the last Conference

[Item 6 of the agenda]

Mr. AHMAD (Afghanistan) reported important developments in the field of surveying and mapping in Afghanistan; first, the establishment of a central cartographic institute in December 1957, and second, the construction of a large modern building for the institute.

The first geodetic base, seven kilometres in length, was being measured south of Kabul by conventional methods and was expected to be completed in December 1961. A reconnaissance had been made for a geodetic triangulation chain between Kabul and Kandahar, for which observation would be started early next summer. The establishment of precise vertical values of benchmarks along main roads and valleys was in progress and eventually the whole country would be covered by a first-order levelling network, the datum being based on the Baltic Sea's mean sea level.

A contract for a nation-wide mapping project had been entered into with the Fairchild Aerial Survey, Inc., of the United States of America, on 31 August 1957. The project covered an aerial survey of the greater part of Afghanistan. The final aim was the production of a series of photomaps at the scale of 1:100,000 and a topographic map at the scale of 1:250,000 with 100-metre contour intervals. The project was scheduled for completion by the end of 1962.

The Ministry of Agriculture was preparing land research and soil survey maps of specific areas.

As a part of the Government's second five-year plan, the parts of the country where mapping was needed were to have 1:25,000-scale coverage and, furthermore, the more developed parts were to be mapped at the scale of 1:10,000.

Mr. RIMINGTON (Australia) said that, thanks to the introduction of electronic distance measuring equipment,

Report on credentials

[Item 4 of the agenda]

The PRESIDENT stated that the report on credentials would be submitted when all the delegations had completed their registration.

Establishment of technical committees

[Item 5 of the agenda]

Dr. TCHANG (Executive Secretary) informed the Conference that at the informal meeting of the Chiefs of Delegations held that morning, it was agreed that the following five technical committees would be desirable:

Committee I: Geodesy;
Committee II: Topography and photogrammetry;
Committee III: Photo-interpretation and topical maps;
Committee IV: International Map of the World, World Aeronautical Charts and geographical names;

¹ Issued as E/CONF.36/SR.2

² E/CONF.36/1 and Corr. 1 and 2.

the geodetic survey of Australia had progressed rapidly and he predicted that soon no point in Australia would be more than 150 miles from an established geodetic control. The geodetic survey of Papua-New Guinea had also commenced and reconnaissance data were being steadily accumulated.

Regarding aerial photography, initial coverage of Australia was almost completed. Introduction of the Wild RC9 super-wide-angle camera had proved very successful on the Australian mainland. But in Papua-New Guinea, the Eagle IX camera had been exclusively used, since the very heavy relief of this territory made the use of the super-wide-angle camera undesirable.

Geological mapping had received an increased stimulus as a result of the intensified search for oil. Private oil companies holding prospecting leases had made a substantial contribution to geological mapping.

A geophysical survey had proceeded in conjunction with the geological mapping and mineral prospecting. Large areas had been covered by air-borne magnetometer and seismic surveys. Scientific and industrial research organizations had carried out valuable regional surveys which would permit planned development of the more sparsely populated areas of the continent.

Mr. GAMBLE (Canada) said that Canada has been undertaking a large and increasing programme of charting and mapping and was therefore extremely interested in any developments that showed promise of improving accuracy or efficiency of surveying and cartographic operations. Many new techniques had been tried out and the information acquired during the course of field and laboratory tests would be made available to interested countries. In return, Canada would like to be informed of new equipment and methods developed in other countries.

Since the second Conference in Tokyo, progress had been made on the construction of a new plant for national surveying and cartographic agencies. A large new building had been completed and occupied early that year and would be officially opened in February 1962; it was one of the most modern buildings designed and built for cartographic purposes. It could be visited by representatives of other survey organizations at any time.

Increased emphasis was being placed on oceanographic research, and a new institute was expected to be completed at Halifax on the east coast in July 1962. One new 105-foot hydrographic survey vessel and a 300-foot oceanographic research vessel were under construction and present units of the east coast survey fleet would be berthed at this institute.

Mr. TSAO (China) reported that in order to revise and recompile all the maps of China, readjustment had been made in recent years of all the triangulation stations, of different orders, throughout the provinces on the China mainland. This complicated work was expected to be completed at the end of 1961.

To establish geodetic ties between the Chinese mainland and the islands off the south-east coast of China, several stations on the adjacent islands, which had had independent and different triangulation nets had been connected in 1958 by means of tellurometer. The data thus obtained could be used for the connexion and readjustment of the triangulation stations on the islands off the south-east coast.

Occultation observations and gravity observations had been made, as well as observations for the determination of the deflection of the vertical in the triangulation systems of Taiwan.

Efforts had also been made to revise existing maps of China in order to bring them up to date.

Photo-interpretation had been used quite extensively. In 1960, a photogeological training class had been held consisting of fifteen students. The Chinese Society of Aerial Photogrammetry was planning to open photo-interpretation courses in universities in Taiwan. Aerial photogrammetric methods had been extensively adopted for land use and forest resource surveys in Taiwan.

In the field of map compilation and reproduction, sufficient progress had been made. Eight sheets of the International Map of the World on the Millionth Scale (IMW) and two sheets of the ICAO World Aeronautical Chart (WAC) had been recompiled. Twenty-four sheets of administrative maps of Taiwan had been compiled. Some topical maps and atlases of China had also been prepared in connexion with the planning of economic development.

A gazetteer containing all the geographic names of Taiwan had been published with romanized spelling.

Mr. HUSSENET (France), in the absence of the representative of France, stated that the report on national cartographic activities would be presented to the Conference at a later meeting.

Mr. GREIG (Federation of Malaya) stated that, as Malaya was represented at the Conference for the first time, no report on comparative progress could be presented.

He pointed out, however, that significant progress had been made and continued to be made in the production of a new series of standard topographical maps on a scale of 1:63,360 (one inch to one mile), increasing use being made each year of photogrammetric equipment.

In general, it might be claimed that the Survey Department had not been found unprepared to meet the challenge of the Government's current intensive rural development drive, on the furthering of which the bulk of the Department's potential was concentrated.

It was hoped that before the next conference the goal of complete standard mapping coverage of the country would be within reach.

Mr. GIGAS (Federal Republic of Germany) reported that while triangulation of the whole country had been completed long ago, it was being checked again for accuracy. New measurements of the base line system were being made by calibration of electronic equipment and related research work. Mapping on the scales of 1:100,000, 1:200,000 and 1:250,000 was finished and new progress had been made in compiling the International Map of the World. The main problem was to keep maps up to date. That problem was solved to a large extent, however, by the use of photogrammetric methods.

Mr. ELSTER (Israel) stated that primary triangulation in Israel had been completed and new control points had been added throughout the country to provide geodetic data for more accurate cartographic work. The new basic network of primary triangulation having been laid down and observations completed, the adjustment was being carried out by the least squares method and the method of stages. Parallel with the adjustment of the primary triangulation network, the adjustment of the precise levelling network had been undertaken. A tide

gauge had been installed at Elath in order to determine the value of the mean sea level. To provide vertical control for various development projects, levelling operations had been increased recently.

A provisional magnetic observatory was under construction. The field measurement of the magnetic elements was being carried out by the field parties of the Survey.

A DC3 aircraft was used for aerial photography. About 8,000-10,000 square kilometres were photographed each year with Wild RC6a cameras, using mostly Aviogon (f-11.5 cm) and Aviator (f-21 cm) lens.

During the period 1958-1961, forty-three sheets of maps at different scales (1:1,000,000 to 1:20,000) had been completed.

A number of photogrammetric mapping projects had been carried out, such as geological mapping, large-scale topographical surveys, land use mapping and engineering surveys with respect to such large projects as construction

of roads, irrigation works, dams and the planning of new settlements.

Topographic maps covering the whole country had been produced by the Survey Department. The plotting was done from vertical aerial photography, and field control was carried out in all parts of the country. All basic maps were scribed on glass to ensure maximum accuracy, whereas general purpose maps were scribed on plastic materials, conventional signs, names and numbers being prepared on strip film and affixed to the plastic sheets or glass plates.

The *National Atlas of Israel*, appearing since 1956, was expected to be completed early in 1963.

Cadastral survey work was being carried out extensively in the southern part of the country: about 70 per cent of the total area had been settled or was under survey for settlement. A numerical cadastral system was used, the data being based on control points and chain surveys.

The meeting rose at 4.45 p.m.

SUMMARY RECORD OF THIRD PLENARY MEETING¹

Held at Sala Santitham, Bangkok, Thailand, on Monday, 30 October 1961, at 9.45 a.m.

CONTENTS

	<i>Page</i>
Progress reports by countries on their respective cartographic activities since the last Conference (item 6 of the agenda) (continued)	8
Organization of work	12

President:

Major-General Busrindre BHAKDIKUL (Thailand)

Progress reports by countries on their respective cartographic activities since the last Conference (continued) [Item 6 of the agenda]

The PRESIDENT welcomed the delegations of Cambodia, India and Morocco and invited them to make reports, if they so desired, on their countries' cartographic activities.

Colonel KARET (Cambodia), emphasizing his country's basic preoccupation with economic and social development, stated that the Service géographique Khmer, established in 1955, had been concentrating its efforts on training its personnel and also on acquiring the latest material on modern cartographic methods. Photogrammetric methods had been introduced and, since 1958, the Section photogrammétrique of the Service géographique had been developed.

Maps had been prepared on scales suitable for various needs: administrative charts on the 1:500,000 scale; road maps on the scale 1:250,000 or 1:400,000, and a topographic map on the scale 1:100,000. These maps were printed by the reproduction unit of the Service géographique. It was planned to prepare maps on the scale 1:10,000 for urban centres and certain other populated areas.

Mr. DIAS (Ceylon) reported that the National Map of the country on the scale 1:63,360 was kept up to date by field revisions. The Survey Department had been undertaking production of large-scale maps for various government departments, for the settlement of crown title to land, for apportioning land for colonization schemes and land development, and for the acquisition of land for public purposes, such as public buildings, roads, power line routes and irrigation engineering projects.

The Air Survey Branch had been set up as a new unit of the Survey Department with the object of adopting air survey methods for the production of large-scale topographical maps and natural resource survey maps. Aerial photographing of special areas for photo studies had been started. The photo laboratory, which had, among other equipment, a logetronic printer and a SEG V rectifier, had begun to operate.

One of the main objectives of the Department was the production by its own map reproduction centre of a National Map on the scale 1:12,672 (sixteen chains to one inch) with twenty-foot contours.

Mapping of towns on the scales 1:792 and 1:1,584 for assessment and town planning purposes, using aerial photography on the scale 1:8,000 and larger, was undergoing test plotting.

Colonel SINHA (India) said that, as the Survey of India had decided to switch over to the metric system and as its objective was the economic development of the country, there had been a considerable increase in its cartographic activities. Referring to geodetic activity, he said that three categories of traverse—primary, secondary and tertiary (or minor)—had been laid down. No extensive primary traverse had been carried out, but secondary traverses had yielded an accuracy of 1:5,000 or more. The geodetic triangulation carried out in India had actually yielded an accuracy of 1:500,000. The static observatory at Sabhawala (Dehra Dun), which was equipped with La Cour's magnetometer and Askania's earth variograph, was expected to start functioning within a short time. It was planned to participate in the Indian Oceanic Research Expedition for magnetic surveys at sea during the minimum sun spot activity period from 1962 to 1964.

Opportunity had been taken during the current IGY/IGC programme to carry out certain special observations, such as earth-tides by the gravimetric method, variation of latitude and longitude observations by the Wild Universal T4, Zenith telescope and transits. Observations had also been carried out for the first time in India for tidal streams in certain gulfs and estuaries. The data were under analysis for the preparation of an atlas of tides and tidal streams for Indian waters.

The general situation in the field of topographical mapping and photogrammetry had changed little from that which existed three years ago. Both normal and wide-angle cameras were used for aerial photography on various scales ranging from large to small, i.e., 1:6,000 to 1:50,000. Distortion-free modern cameras, such as the Wild RC5a were used for large-scale precision surveys; the Eagle IX was used for surveys of various projects and flood control investigation surveys of lesser accuracy. The photographic quality was of an average standard. Navigation was carried out using visual methods.

The whole of India is covered by a series of accurate topographical maps on the scale of four miles to one inch (1:253,440), which are used for the compilation of geographical maps and thus eliminate the necessity of using third-order photogrammetric instruments for compilation of geographical maps.

Graphical adjustment of short strips of spatial aerial triangulation was carried out by Zarzycki's second-order graphical interpolation methods. Though at present the

¹ Issued as E/CONF 36/SR.3.

smallest scale of photography used in India was 1:50,000, India was in favour of using super-wide-angle cameras for aerial photography in the preparation of small-scale topographical maps. For medium-scale topographical mapping, the scale of photography varied from 1:15,000 to 1:40,000 and depended on the photo-to-map enlargements necessary. The mapping was carried out mostly in Wild type cameras A8s and, in rare cases, A7s.

For mapping on the scales of 1:1,000 to 1:25,000, the scales of aerial photography were kept between 1:6,000 to 1:15,000.

The cadastral survey of India was carried out by the State Revenue Authorities using ground survey methods. A move was afoot to connect all the cadastral surveys with the existing national geodetic network.

In photo-interpretation and topical maps, a modest start in the use of aerial photographs for producing soil maps had been made in the Soil Section of the Indian Agricultural Research Institute, New Delhi. Aerial photographs and photomosaics were being used in India for urban analysis and town planning on a limited scale. The economy of the use of aerial photographs for topographical mapping was appreciated, and aerial photographs had been used for the exploitation and utilization of mineral resources, forest resources, other natural resources and for soil conservation schemes. The National Atlas Organization of India was compiling atlas maps in which emphasis was given to socio-economic distributional patterns.

India had been concentrating on the preparation of both the IMW and the ICAO WAC on the scale 1:1,000,000, using a different set of specifications for each series. Out of twenty-one sheets of the IMW series, four sheets would probably be published by the end of 1961 and the other sheets were in various stages of drafting and printing. Out of twenty-three sheets of the ICAO series, eleven sheets had been published and the others were in print.

An Advisory Board had been set up by the Government of India with a view to standardizing on a national basis the methods of transliteration of standard scripts to be used on regional maps, and also to finalize the spelling of place names on maps of foreign countries appearing in atlases produced in India.

Outlining the activities of the Hydrographic Department, Colonel Sinha said that a new surveying ship, the *Darshak*, whose keel had been laid on 14 October 1957, was under construction at the Hindustan Shipyard, Vishakhapatnam. The ship had been launched on 2 November 1959 and was to be provided with a helicopter and two thirty-five-foot survey launches. The Hydrographic School had been established in Bombay in 1959 and moved to Cochin in October 1961; it undertook the training of hydrographic officers from the maritime states and major ports in India. After the initial period of training and consolidation, the Hydrographic Department published the inaugural chart of Elphinstone Harbour and Approaches (Andaman Island) on 15 January 1959. Two Decca chains, the Bombay chain and the Calcutta chain, were being established.

Mr. HAIDER (Iraq) stated that the primary triangulation carried out a few decades ago in his country could not be classified as very accurate and it needed to be replaced by new surveys conducted with the use of high-precision instruments. Preparatory steps for such surveys

had been taken using electronic equipment. The secondary and tertiary triangulation, as well as the precise levelling which had been completed about fifty years ago, were in need of revision.

During the past two years, an area of approximately 561,000 hectares of cultivable land had been divided, and during the next five years another area of 2 million hectares would be distributed and given to approximately 40,000 farmers.

Iraq was now engaged in one of the most extensive photogrammetric projects, in which aerial photography and photogrammetric mapping would be used over an area of approximately 350,000 square kilometres. The project, starting in August 1961, was planned to be finished in forty-two months.

At present, approximately two-thirds of the country, which is nearly all cultivable area, was shown on cadastral maps.

Dr. NAKANO (Japan) reported that, with a view to standardizing maps, the Geodetic Society of Japan was planning a large-scale mapping project consisting of taking aerial photographs, establishing more intensive ground controls and mapping. To undertake surveying and mapping in fields such as civil engineering, better land use, reclamation and so on, the Private Enterprises Association of Japan had been established in June 1961, and a new photogrammetric association was planned to carry out the activity previously undertaken by the Geodetic Society of Japan. Aerial photo-interpretation had been used in planning reconstruction work in certain inundated and flooded areas.

The publication of topographical maps of the bottom of the Bay of Tokyo was a noteworthy achievement in the field of hydrography. The maps had been compiled for the redevelopment of the metropolitan area by means of echo sounding. Japan had also been preparing for the world magnetic survey which started in April 1961.

Mr. PHANARETH (Laos) reported that the Service géographique nationale had increased its staff from none in 1955 to twenty-seven in 1957, sixty in 1959 and 110 in 1960. Considering the work which lay ahead for the topographical mapping of 160,000 square kilometres and for a cadastral survey of 240,000 square kilometres, the staff was still too small.

In the field of geodesy, the first-order network had been almost finished, except for only two or three points in the north of Luang Prabang. The first-order network of Laos was in full concurrence with that of Cambodia and Viet-Nam, but, in spite of the common border of 1,500 kilometres, there was still no geodetic connexion between Laos and Thailand.

The first-order levelling had been undertaken to connect all points lying beyond thirty kilometres from the first, second and third-order levellings. So far, fifty kilometres had been levelled out of a total of 1,600.

The Service géographique nationale had a very limited amount of photogrammetric equipment. The first set of aerial photographs had been taken on the scale of 1:40,000 between 1952 and 1955, and the second set during 1958-1959. In 1959, the Royal Ordinance entrusted the Service with the cadastral survey work, and plans were being made for such a survey. The Commission nationale de toponymie was established to standardize geographic names.

Lieutenant-Colonel OH (Republic of Korea) stated that two mapping agencies, the Army Map Service of the Republic of Korea and the National Reconstruction Research Institute, were engaged in map production. The Institute was established in September 1958 to prepare civilian maps, although the Army Map Service also produced some civilian maps, though not enough to meet all the requirements.

The Army Map Service had re-established 30 per cent of the destroyed control stations and recovered 50 per cent of the damaged control stations by the use of survey parties. With the application of the Transverse Mercator projection, aerial photography and the latest cartographic techniques, the Army Map Service had made remarkable improvements in mapping. The Service expects to receive multiplex equipment, reflecting projectors and drafting equipment in 1962, and more improvements may be anticipated.

Upon the establishment of the National Reconstruction Research Institute, the Government organized the Central Place Names Committee to re-establish or standardize administrative place names throughout Korea.

The Army Map Service had reproduced and maintained a number of tactical and other maps.

Mr. JAMIL (Morocco) said that mapping had been done of the whole of Morocco, but that the maps, varying in scale from 1:500,000 to 1:50,000, did not have a uniform accuracy since they had been prepared in response to expediency. However, economically important regions had been mapped with great accuracy at the scale 1:50,000. Triangulations of first and second order connecting with similar nets of neighbouring countries would be completed by 1962. The Government had also undertaken preparation of a geophysical map. The Topographical Service had planned cadastral surveys on the scales 1:5,000 and 1:2,000. A number of student engineers had been sent to France for training.

Mr. SCHERMERHORN (Netherlands) said that he would prefer to participate in the discussion on technical matters at the Committee meetings.

Captain PALMA (Philippines) stated that in the field of geodetic activity, the triangulation work carried out during the past three years covered only a limited area, and new surveys were more or less limited to hydrographic surveys for compiling charts of important harbours. An extensive gravity station network had very recently been established by the United States Army Map Service. About forty gravity base stations had been established and 400 more were planned.

Hydrographic survey work was confined mostly to important ports and harbours. Two new survey vessels, presented by Australia, were expected to increase hydrographic activity in the Philippines.

An Aeronautical Chart Section had been established in the Philippines Coast and Geodetic Survey in 1960. Compilation of the series of the World Aeronautical Charts (ICAO) at the scale of 1:500,000 had already been started. Publication of a topographic map series consisting of fifty-five sheets at the scale of 1:250,000 had been initiated.

Controlled photomosaics of important watershed areas, to be used for irrigation, river control and other economic development projects, covered approximately 30 per cent of the country's land area. The acceleration of cadastral

surveys by the use of aerial photogrammetric methods was being implemented.

Mr. SHIGDAR (Saudi Arabia) said that the geographical and geological mapping project, initiated in 1954 and sponsored jointly by Saudi Arabia and the United States Department of State, was in progress, and the publication of 1:500,000-scale geographical and geologic surface maps for all of Saudi Arabia, covering an area of 1,165,000 square miles, was nearing completion. Twenty-one geological and twenty-one geographic maps were scheduled for publication.

The Kingdom of Saudi Arabia had been completely covered by high-altitude vertical aerial photography.

In 1958, a preliminary edition of a geographical map of the Arabian Peninsula at the scale of 1:2,000,000, printed in both English and Arabic, had been published. A revised edition of this map was in preparation.

In accordance with the agreement entered into by the Government with Bahrain, a geodetic survey had been carried out by the Aero-Service Corporation in order to establish permanent reference points for the determination of the boundary of the country.

The Aero-Service Corporation had also performed aerial photography of the western Arabian Shield; this had been done in four operation seasons (from January 1956 to November 1958) and covered 312,900 square miles. Aerial photography of the southern central area covering 76,000 square miles had also been accomplished by the Corporation.

To supply the specific projects, such as development of natural resources and construction of highways and airports, with the necessary topographic maps, the Ministry of Petroleum and Mineral Resources planned to establish a photogrammetric section in the Directorate General of Mineral Resources.

Mr. LUNDGREN (Sweden) said that the Geographical Survey Office had been concentrating its efforts on two main activities: (1) an economic or general land use map on the scale of 1:10,000 based on a controlled mosaic, and (2) a modern topographical map on the scale of 1:50,000 produced for the same areas as the first map. The Swedish Parliament recently decided upon a new long-term production programme for the official maps, covering the next ten years.

The efficiency and accuracy of the maps prepared were checked by testing and by systematic time studies. Many governmental organizations working in this field also did a lot of work on commercial terms. Printing and distribution of the official maps were being done by the Swedish Mapping and Printing Organization, which had recently been established.

Mr. SCHOLL (Switzerland) said that in Switzerland, while a large part of the official programme was performed by private undertakings, the official organizations took care of the proper co-ordination of the work done. Although the national triangulation network from the first to the third order, with a density of one point per twenty square kilometres, had been completed about thirty-five years ago, new surveys were being undertaken within the framework of the over-all adjustment of the European triangulation net. Various special levelling surveys had been carried out in 1959 and 1960 in subsidence areas. The levelling network had also been included in the adjustment of the European levelling system, from

which interesting conclusions had been reached on the determination of absolute heights above mean sea level.

The new topographical maps at the scales 1:25,000 to 1:100,000 were prepared by using photogrammetric methods. In order that the foundations for the general plans might be laid at the same time, the photogrammetric plotting of Central Switzerland and the Jura region had been done in co-operation with the Federal Survey Directorate at the scales 1:5,000 or 1:10,000 from photography at the scale 1:14,000 to 1:25,000.

A number of special maps had been prepared—maps showing cable communications of the Federal Post, Telegraph and Telephone Administration, a map of Mount McKinley, Alaska, a 1:100,000-scale map of the Aletsch Glacier for glaciological investigation, and so on.

The Swiss Federal Directorate of Cadastral Surveys had completed the survey of over 65 per cent of the area to be surveyed. Wider use of photogrammetry and the introduction of electronic computers had been contemplated for speed and accuracy in surveying, while the Survey Directorate was testing the possibilities of automation in its project of map revision. In preparation of general cadastral plans at 1:5,000 and 1:10,000 scales, cadastral surveys had been completed for about 90 per cent of the area concerned. There were private survey firms, of which ten were equipped with photogrammetric plotting instruments, which received contracts from both official and private sources.

The Swiss Geodetic Commission concerned itself with many activities, such as the determination of the geoid in the Bernese Alps, gravity surveys with a Worden gravimeter for the determination of the Swiss gravity net (123 stations), measurement of the Heerbrugg Base, and others.

Colonel CHUMPHON (Thailand) stated that since 1954 topographical maps had been compiled in Thailand by photogrammetric methods. Almost the whole area of Thailand had been photographed. The scales of the aerial photographs were between 1:40,000 and 1:60,000. Some specified areas had been re flown to obtain aerial photographs at larger scales (from 1:4,000 to 1:20,000). The stereo-compilation of the Survey Department had been worked out by means of stereoscopic plotting instruments, such as the Wild autograph A6, the Kelsh plotter and a multiplex plotter, while the aero-triangulation had been carried out by the United States Army Map Service.

Drafting was done by plastic scribing on mylar coated with Scriberite orange. At first, scribing tools with steel points were used, but since the middle of 1960, jewel-pointed tools had been introduced.

The topographic map of Thailand on the scale 1:50,000 was composed of 1,216 sheets and was expected to be completed by 1964. The geographical names on the maps would be in two languages, Thai and English.

In order to train surveyors for both military and civilian services, the Survey Department had set up its own survey school.

Considerable progress had been made in the first-order triangulation. The first-order levelling of Thailand had been extended to a distance of 1,753 kilometres consisting of ninety-two (BMP) bench-marks of primary order and 1,005 secondary bench-marks. Two Laplace stations had been established in the north-east and the south of Thailand. A plan to establish four other Laplace stations

during 1961-1962 was contemplated for the southern part of Thailand.

During the past three years, Thailand had established 410 gravimetric stations. The magnetic observation had been accomplished at about seventy-nine stations with the aid of a dip circle, an earth inductor, a magnetometer of Indian pattern, a magnetic travel theodolite and different variometers. Geomagnetism operations in the field had resulted in forty-five stations.

Mr. HUMPHRIES (United Kingdom) invited the attention of the delegates to the paper (E/CONF.36/L.84) submitted by his delegation, in which a detailed report on the cartographic activities of the United Kingdom was given.

Rear-Admiral KARO (United States of America) referred the Conference to document E/CONF.36/L.29 for a detailed report on cartographic activities in the United States, but mentioned the following important points:

Geodesy. The extension of triangulation and level networks was being continued. In addition to the control established for regular surveying operations, control was also established specifically for highway construction, military projects, water resources development, aeronautical aids, positioning and testing of modern weapons for the Department of Defense and for outer space guidance.

A Blue Nile river basin geodetic control project had been undertaken by the Ethiopia-United States Co-operative Programme for the study of the water resources of the Blue Nile river basin in Ethiopia.

A total of ninety-two astronomic positions and sixty-one azimuths were observed in the United States and other areas in connexion with control of triangulation, earthquake studies and various national defence projects.

Assistance was rendered by various military agencies in providing deflection of the vertical data at several rocket launching and observing facilities.

Gravimetry. The United States Navy Hydrographic Office had successfully employed La Coste and Romberg gravity meters aboard submarines and surface ships. A concerted programme to collect ocean gravity observations had been under way since May 1960, and the ultimate goal was a general gravity survey of all ocean areas.

Geomagnetism. The regular five-year series of isogonic charts of the world continued with a new issue published in 1960 by the Navy Hydrographic Office. The United States Coast and Geodetic Survey had also published an isogonic chart of the United States. A chart showing the magnetic declination in the Great Lakes area has been published by the United States Lake Survey and a set of charts at the scale of 1:5,000,000 would be published by the Army Map Service.

The acquisition of new world-wide data through correspondence and exchange was growing, looking toward the planned work on the 1965 magnetic charts. One of the sub-centres of World Data Centre A, operated for the collection and exchange of data in geomagnetism, seismology and gravity, had continued to function. The Office processing of IGY and IGC results from magnetic observatories was also continuing.

Seismology. The temporary stations established as part of the IGY seismology programme continued to be

in operation and contributed a vast storehouse of basic seismic information. Approximately 1,300 earthquakes with magnitudes greater than 5.5 had been located annually in the past two years.

Topographic maps and photogrammetry. During this period, the Geological Survey published over 3,900 new topographic maps in the 7.5 and fifteen-minute series covering nearly 969,000 square kilometres. In 1958, as a result of a change in policy, the Survey had adhered to specifications for 1:24,000-scale maps in all its mapping of all the country, except Alaska. Outside the country, the Survey continued a limited mapping operation in Antarctica.

Aerial photography was now available for the entire area of the fifty states, Puerto Rico and the Virgin Islands. Through the International Cooperation Administration (ICA), various federal mapping agencies of the United States of America extended technical assistance to other nations, notably, Brazil, Ceylon and Libya.

In geodetic control for topographic mapping, the Survey had accomplished spirit levelling to provide vertical control for 588,140 square kilometres of topographic mapping, 42,194 kilometres of transit traverse and 390,804 square kilometres of third-order triangulation.

Hydrography and oceanography. The Office of Oceanography continued a long-range programme of hydrographic surveys, basic surveys, revision surveys and wire-drag surveys, within the prescribed area of responsibility. Publication of the Small-craft Chart Series 101 had begun.

As a part of the Canadian and United States effort to improve charting for the safe navigation of vessels engaged in the establishment and resupply of Arctic weather and radar stations, the United States Navy Hydrographic Office had conducted surveys in Baffin Bay and in Melville Bay, Greenland.

During this period technical specifications for the worldwide ocean surveys were completed to ensure standardization of data observations made by the United States and by foreign organizations during the proposed ocean surveys.

Tides. Control tide stations were maintained at selected sites to provide long-period observation data. Steps had been taken to strengthen the seismic sea wave warning system in the Pacific.

Aeronautical charts. A great increase in air operations, resulting in a limitation of air space, necessitated extensive

review and redevelopment of aeronautical charts and flight information publications.

First consideration had been given to the analysis of the chart requirements for instrument flight in view of the separation of air traffic (in 1961) into three altitude layers—low, intermediate and high.

Twenty-six charts in the new Global Navigation and Planning Series at the scale 1:5,000,000 had been published.

Special maps. A number of geologic maps, such as maps of mineral investigations, coal maps, oil and gas maps and geophysical investigation maps, had been published. A map had been developed by the Geological Survey on which areas inundated by floods were indicated. Fifty-three political-physical maps were currently scheduled for the National Geographic Atlas Map Series.

Cadastral surveys. The survey record represents the descriptive title of approximately 1,718,750 square miles (4,451,562 square kilometres) of land which the Federal Government had patented from the public domain. Except for Alaska, where less than one per cent of the land had been surveyed, only a small part of the public lands had not been covered by the rectangular public land cadastral survey system.

Organization of work

Dr. TCHANG (Executive Secretary) suggested the following assignment of items for the technical committees :

Committee I. Geodesy : item 10 ;

Committee II. Topography and photogrammetry : item 13 ;

Committee III. Photo-interpretation and topical maps : items 14 and 15 ;

Committee IV. International Map of the World, World Aeronautical Charts and geographical names : items 16, 17 and 18 ;

Committee V. Magnetic surveys and world magnetic charts ; hydrography and oceanography : items 11 and 12.

It was so agreed.

The meeting rose at 12 noon.

SUMMARY RECORD OF FOURTH PLENARY MEETING¹

Held at Sala Santitham, Bangkok, Thailand, on Monday, 30 October 1961, at 2.30 p.m.

CONTENTS

	<i>Page</i>
Progress reports by countries on their respective cartographic activities since the last Conference (item 6 of the agenda) <i>(concluded)</i>	13
Establishment of a regional inter-governmental cartographic organization (item 8 of the agenda)	13
Establishment of a regional training centre for surveying and mapping (item 9 of the agenda)	13

President :

Major-General Busrindre BHAKDIKUL (Thailand)

Progress reports by countries on their respective cartographic activities since the last Conference *(concluded)*

[Item 6 of the agenda]

Mr. LACLAVERE (France) said that he had nothing specific to report, although France had been very active in cartographic research. However, he looked forward to his participation in technical meetings of different committees and hoped that deliberations in those meetings would be conducive to promoting techniques for minimizing the costs and increasing the speed of cartographic operations.

Dr. MUKERJEE (Food and Agriculture Organization of the United Nations) said that FAO had mainly been interested in mapping soils for agricultural purposes, such as marking of fallow lands, finding out means for increasing production, and investigating the potentialities of land already under cultivation. FAO had been helping through expert advice and by sending specialists to countries to prepare such maps as genetic soil maps, land use maps, irrigation and soil conservation maps. Work in connexion with the preparation of the World Soil Resources Map had been undertaken at FAO Headquarters in Rome.

Mr. JANSZ (International Civil Aviation Organization) described the role of ICAO as a co-ordinating agency for aeronautical charts of different kinds. To ensure regularity, safety and standardization of air navigation, ICAO had suggested twelve types of specified charts, of which four had been made obligatory upon member nations. The imperative task of ICAO was to keep all aeronautical charts up to date.

Dr. GIGAS (European Organization for Experimental Photogrammetry Research) stated that the OEEPE had been studying photogrammetric problems and had published a number of reports and valuable articles on the subject. He expressed the hope that the research work done in that Organization would help the Asian countries to make the best use of photogrammetry in geodetic and mapping work.

Mr. LACLAVERE (International Geographic Union and International Union of Geodesy and Geophysics) reported that the IGU followed with utmost interest the conclusions of the cartographic conferences and that IUGG was interested in two large cartographic projects : the World Magnetic Survey and the General Bathymetric Chart of the Oceans.

Establishment of a regional inter-governmental cartographic organization

[Item 8 of the agenda]

Establishment of a regional training centre for surveying and mapping

[Item 9 of the agenda]

The PRESIDENT opened item 8 of the agenda for discussion.

Colonel CHUMPHON (Thailand) stated that due to the lack of adequate financial resources, it might not be feasible at this juncture to set up a large inter-governmental regional cartographic organization, and suggested a realistic approach to the problem of setting up a regional training and study centre for (a) teaching various techniques of map making, (b) technical advisory services to the countries of the region, and (c) the administration of intra-regional projects.

The establishment of such a centre should again be preceded by a study of the detailed procedure to be followed and of the organizational structure to be adopted. For this purpose, a working group should be constituted.

Rear-Admiral KARO (United States of America) said that his Government was greatly interested in such an organization and was willing to associate with it by actually participating in the technical projects and by offering material assistance.

Mr. SCHERMERHORN (Netherlands) proposed that items 8 and 9 of the agenda be discussed together.

Referring to item 9, he said that while the proposition of opening a regional training centre for surveying and mapping appeared interesting, it was necessary to realize that it was a rather complicated one. It covered many fields and the training programme would accordingly have to be varied. Thus, in the training of experts for geodesy, topography, ground surveying, map preparation, etc., each field would demand a different training approach, different equipment and a different organizational set-up. He pointed out that, even in closely related fields, such as photogrammetry and photo-interpretation, the training would have to be different.

Speaking from his own experience, he cautioned that the financial implications of setting up a comprehensive training centre covering all these fields would be tremendous. Highly technical subjects, such as photogrammetry,

¹ Issued as E/CONF 36/SR.4.

could better be left out of the training programme for the moment. In order to achieve concrete results, he recommended a simple training programme. Moreover, he offered, on behalf of the International Training Centre for Aerial Survey, Delft, a trained staff and material for the purpose of higher specialized training in this field. He felt that a short-term course of about a year or two at the Institute was more than sufficient for a trainee who had already had basic training in his own country.

Mr. GAMBLE (Canada) expressed his agreement with the views of the delegate of the Netherlands and quoted his own experience in the field. He said that a number of foreign students had been going to distant countries in order to undergo training. In this, he felt much valuable time and money was lost. If there was an opportunity for trainees to acquire basic training in their own country or within their region, it would be quite economical for them to go to other countries for short-term specialized training.

Dr. NAKANO (Japan) summarized the remarks so far made by other delegates and observed that there appeared a general lack of enthusiasm for establishing a regional cartographic training centre on a large scale.

As an alternative, he recommended, as a practical measure, the establishment, through ECAFE, of an Asian Working Committee to act as liaison among the countries for their common projects and also between the countries in the region and the United Nations, to take follow-up action on decisions already taken and to report the progress made to subsequent regional conferences. The cost for such a committee would not be expensive.

Referring to the proposal contained in document E/CONF 36/L.62, he said that, due to financial difficulties, it might not be possible to establish in the near future the proposed training centre for photo-interpretation. To meet this situation, he strongly recommended the holding of a seminar on aerial photo-interpretation at an early date.

He agreed that items 8 and 9 were interrelated and could be discussed together.

Rear-Admiral KARO (United States of America), referring to the views expressed by the delegates of Canada and the Netherlands, said that, in order to arrive at some concrete solution on these items at the Conference, a thorough study of the proposals was necessary.

Mr. SCHERMERHORN (Netherlands) proposed the establishment of a special working group for this purpose.

Mr. HUMPHRIES (United Kingdom) supported the proposal made by the Netherlands.

Rear-Admiral KARO (United States of America) also supported the idea of establishing the working group.

The PRESIDENT summarized the views expressed by the delegates and said that it had been proposed that

items 8 and 9 of the agenda be entrusted to a small working group which would report its conclusions to the Conference. The group was to be formed of delegates representing countries of the ECAFE region. He requested, however, that the chief delegates of Australia, Canada, France, the Netherlands, the United Kingdom and the United States of America act as advisers to the group.

The PRESIDENT then put forward for approval the proposal for establishing a working group.

The proposal was accepted.

The following ECAFE countries expressed their willingness to be represented in the working group: Cambodia, Ceylon, China, the Federation of Malaya, India, Japan, Laos, the Philippines and Thailand.

Colonel CHUMPHON (Thailand) wanted to know whether more than one representative from a country could be a member of the working group.

The PRESIDENT said he would welcome all those who wished to join the working group.

Rear-Admiral KARO (United States of America) referred to his delegation's paper, E/CONF.36/L.31, entitled "Consideration of recommendations of the United Nations Seminar on Aerial Survey Methods and Equipment",² which recommended that the Conference consider the needs of the nations of the region and proposed the kind of sequential cartographic programme that would provide the most feasible and economic procurement of survey, map and chart data for the needs of a typical nation of the region.

Mr. TSAO (China) proposed that the recommendations in this paper should also be assigned to the working group.

Mr. GREIG (Federation of Malaya) wanted to know whether the proposal for the establishment of an aerial survey training centre, as noted in document E/CONF.36/L.62,³ could also be included for study by the working group.

It was agreed that the working group would discuss items 8 and 9 of the agenda and the recommendations and proposals contained in documents E/CONF. 36/L. 3/and L.62.

Colonel SINHA (India) pointed out that the working group had to have a chairman and a secretary to report its deliberations to the Conference.

Dr. TCHANG (Executive Secretary) said that the working group could elect its own chairman and rapporteur.

The meeting rose at 4.15 p.m.

² Reproduced in part II of the present volume, under item 13 (a) of the agenda.

³ Reproduced in part II of the present volume, under item 9 of the agenda.

SUMMARY RECORD OF FIFTH PLENARY MEETING¹

Held at Sala Santitham, Bangkok, Thailand, on Tuesday, 7 November 1961, at 2.40 p.m.

CONTENTS

	<i>Page</i>
Report on credentials (item 4 of the agenda)	15
Reports on progress in matters which formed the basis of the resolutions or recommendations at the last Conference (item 7 of the agenda)	15

President:

Major-General Busrindre BHAKDIKUL (Thailand)

Report on credentials [Item 4 of the agenda]

The PRESIDENT said that the two Vice-Presidents and himself had examined the credentials submitted to the Executive Secretary by the delegates attending the Conference and had found them in order. He added that these credentials were concerned only with the representatives and official observers of Governments.

The report on credentials was adopted unanimously.

Reports on progress in matters which formed the basis of the resolutions or recommendations at the last Conference [Item 7 of the agenda]

The PRESIDENT opened consideration of this item and asked the representative of the United States of

¹ Issued as E/CONF.36/SR.5.

America whether he wished his report (E/CONF.36/L.30)² to be discussed item by item.

Rear-Admiral KARO (United States of America) said that the report was submitted for information. He expressed his hope that the Conference would make a sustained effort to come up with some concrete actions for the implementation of the resolutions and recommendations in question in order to bring about progress in some projects of continued interest.

The PRESIDENT called on the Executive Secretary for comments and advice.

Dr. TCHANG (Executive Secretary) said that at this juncture he had nothing new to report on this item. He added, however, that with regard to possible action it might be worthwhile to consider the various suggestions made to the Committees in connexion with the study of related matters. He understood that several delegations were working on the text of proposals for consideration by the Conference, and he reminded delegates that these proposals should be handed in to the Secretariat as soon as possible, in order that they might be reproduced in time.

The meeting rose at 2.45 p.m.

² Reproduced in part II of the present volume, under item 7 of the agenda.

SUMMARY RECORD OF SIXTH PLENARY MEETING¹

Held at Sala Santitham, Bangkok, Thailand, on Thursday, 9 November 1961, at 4.45 p.m.

CONTENTS

	<i>Page</i>
Final arrangement of the agenda	16

President:

Major-General Busrindre BHAKDIKUL (Thailand)

In the absence of the President, Captain Cayetano PALMA (Philippines), First Vice-President, took the Chair.

Final arrangement of the agenda

The PRESIDENT called upon the Executive Secretary to report on the work of the Drafting Committee.

Dr. TCHANG (Executive Secretary) reported that the Drafting Committee, composed of the Officers of the Conference and the Chairmen of the Committees, after general discussion of the agenda, had agreed that the items should be rearranged for a more co-ordinated presentation in the report of the Conference. He presented the draft final agenda as agreed by the Committee and stated that all the suggestions received were already incorporated in it.

The Drafting Committee had also agreed that the report of the Conference should consist of two chapters, the first presenting a brief account of the Conference and the second giving the resolutions adopted. The reports of the Committees should be reproduced as annexes.

He drew the attention of representatives to the draft texts of the reports of the Committees and said that he

would appreciate it if the delegates would forward any suggestions they might have at their earliest convenience.

Mr. LACLAVERE (France) questioned the necessity of approving the agenda for a second time. He also felt that the time allowed to study the resolutions and discuss them was rather inadequate. Finally, he wished to be informed on the procedure and the time for proposing items for the agenda of the next conference.

Dr. TCHANG (Executive Secretary) explained that the trend of the discussions in the Committees indicated that it was necessary to rearrange the items of the agenda.

Regarding the agenda for the next conference, he believed that, as a normal procedure, the question could only be raised after the Conference had received a formal proposal for recommending such a conference. He was unable to predict when such a proposal would be made.

The PRESIDENT submitted the draft final agenda for adoption.

The draft final agenda was adopted unanimously.

Dr. TCHANG (Executive Secretary) suggested that, in view of the limited time available before its closing session, the Conference might wish the Drafting Committee to make a preliminary review of the draft reports of the five Committees and the informal Working Group. The Drafting Committee could then report to the Conference at its next plenary meeting.

The PRESIDENT submitted the proposal for approval.

It was so agreed.

¹ Issued as E/CONF.36/SR.6/Rev.1.

The meeting rose at 5 p.m.

SUMMARY RECORD OF SEVENTH PLENARY MEETING¹

Held at Sala Santitham, Bangkok, Thailand, on Friday, 10 November 1961, at 11.50 a.m.

CONTENTS

Question of convening a fourth Regional Cartographic Conference for Asia and the Far East	Page 17
---	------------

President:

Major-General Busrindre BHAKDIKUL (Thailand)

Question of convening a fourth Regional Cartographic Conference for Asia and the Far East

The PRESIDENT drew the attention of the Conference to a draft resolution submitted jointly by the Philippines and Thailand and reading as follows :

"The Conference,

Noting that the interval of two successive regional cartographic conferences for Asia and the Far East has been three years,

Recommends to the Economic and Social Council to convene the next United Nations Regional Cartographic Conference for Asia and the Far East not later than 1964".

Captain PALMA (Philippines) said that his Government, fully realizing the benefits that could be derived from regional cartographic conferences, would support the next conference being held in 1964.

The PRESIDENT put the draft resolution to the vote.

The draft resolution was adopted unanimously.

The PRESIDENT said that several representatives had informed him of their desire to offer comments regarding the next conference.

Mr. LACLAVERE (France) recognized that such regional cartographic conferences were very interesting and useful. They facilitated exchange of technical information among the participants, gave opportunity for developing and strengthening the bonds of friendship, and as a result, generated a pleasant atmosphere. He felt, however, that there was room for improving the efficiency of the meetings.

He observed that the programme was rather over-ambitious. Considering the duration of the Conferences and the strength of the delegations, the Conference could do with fewer items on its agenda. This measure would improve the quality, increase the speed and enhance the efficiency of the proceedings. He recommended that the Conference limit itself, in the future, to topographic and cartographic activities only.

He advised the Conference to avoid competition with other international scientific organizations in order to eliminate duplication, and stressed the usefulness of

cartographic seminars, such as those organized by the United Nations in Tehran and Bangkok.

Mr. HUMPHRIES (United Kingdom) supported the proposals of Mr. LACLAVERE and agreed that the Conference should have a shorter agenda and be confined to topographic and cartographic problems.

Rear-Admiral KARO (United States of America) said that he was aware that many papers submitted by his delegation would not strictly fall under the topics covered by cartography. However, he pointed out that such papers were for information only and were quite useful. They generated great interest and discussion and laid a path for further contacts among the cartographic services of the region. He suggested that future agenda could be composed of two kinds of items, one for actual work and discussion, and the other for "homework".

Mr. SCHERMERHORN (Netherlands) expressed his entire agreement with the views expressed by Mr. LACLAVERE (France), but added that, while each Conference could be provided with a definite programme, it should have full freedom to add any new items which would assume importance at the last minute.

Rear-Admiral KARO (United States of America) suggested that the Working Group might work out, under the guidance of the Secretariat, an agenda for the next Conference. That agenda could later be modified according to the suggestions or amendments received from different countries.

Mr. HUMPHRIES (United Kingdom) urged that the agenda for the next Conference be prepared as early as possible, so that delegations would have enough time to prepare their papers.

Mr. ELSTER (Israel) expressed his entire satisfaction with the manner in which the Conferences had so far been conducted and welcomed the large amount of informative papers received at these Conferences which contained very valuable information.

Commander TABIN (Philippines) said that his delegation was glad that so many interesting technical papers had been submitted and he would like to encourage the delegations to do the same in the future. He observed that, even if it were not possible to study all of them in detail at the Conference, the participants could take them home for study as well as for distribution to their interested national services.

Instead of reducing the number of items on the agenda, he considered that the solution to the problem would be to increase either the duration of the Conference or the strength of the delegations. He stressed that, for the countries in the region, the regional conferences proved to be more useful than international conferences and, therefore, he would not like to have their usefulness reduced on any account.

¹ Issued as E/CONF 36/SR. 7.

Rear-Admiral KARO (United States of America) suggested that the Working Group might recommend the holding of seminars or discussions on subjects not falling into the category of topographic and cartographic problems.

Mr. SCHERMERHORN (Netherlands) approved the proposal of the delegate from the United States of America and said that the Working Group could also take the initiative in preparing a draft agenda.

Dr. TCHANG (Executive Secretary) said that the provisional agenda of the present Conference had been based on proposals received from Governments. It was likely that a similar procedure would be followed in the preparation of the proposed Conference. If the Working Group could reach concrete conclusions on the items to be included in the agenda, their proposals could be forwarded to the Economic and Social Council in the form of communications from Governments agreeing with the Working Group.

The meeting rose at 12.20 p.m.

SUMMARY RECORD OF EIGHTH PLENARY MEETING¹

Held at Sala Santitham, Bangkok, Thailand, on Friday, 10 November 1961, at 3.05 p.m.

CONTENTS

	<i>Page</i>
Consideration of draft resolutions proposed by the technical committees	19
Draft resolutions proposed by the Working Group on Regional Organizations	19
Adoption of the report of the Conference (item 19 of the agenda)	19
Closing of the Conference	20

President:

Major-General Busrindre BHAKDIKUL (Thailand)

Consideration of draft resolutions proposed by the technical committees

The PRESIDENT invited the Conference to consider the draft resolutions proposed by the technical committees. He reported that a meeting attended by the Officers of the Conference, the Chairmen of the technical committees and the Executive Secretary, had acted as a drafting committee to harmonize the texts of these draft resolutions.

DRAFT RESOLUTIONS SUBMITTED BY COMMITTEE I *Geodesy*

The draft resolutions submitted by Committee I, as amended, were adopted unanimously without discussion.

DRAFT RESOLUTIONS PROPOSED BY COMMITTEE II *Topography and photogrammetry*

Mr. SCHERMERHORN (Netherlands) observed that one proposal for a resolution on aerial triangulation had not been included in the draft report of Committee II. He wondered whether there was an error.

Dr. TCHANG, speaking as the Secretary of the Drafting Committee, reported that the proposal had been examined in the Drafting Committee. With the consent of the Chairman of Committee II, however, the Drafting Committee had decided that there was no need to include this resolution.

Mr. SCHERMERHORN (Netherlands) proposed that the decision of the Drafting Committee be reconsidered.

Mr. LACLAVERE (France) and Rear-Admiral KARO (United States of America) supported the inclusion of the resolution.

It was so agreed.

Mr. VORAVONG (Laos) stated that the text of the resolution on mapping of border areas was not yet finalized. Since this resolution concerned only a few countries, he requested the permission of the Conference to finalize,

with the interested parties, the present text after the Conference.

Rear-Admiral KARO (United States of America) asked that the new text be translated into English.

It was so agreed.

With this understanding, the draft resolutions submitted by Committee II, as amended, were adopted unanimously.

DRAFT RESOLUTIONS PROPOSED BY COMMITTEE III

Photo-interpretation and topical maps

The draft resolutions submitted by Committee III, as amended, were adopted unanimously without discussion.

DRAFT RESOLUTIONS PROPOSED BY COMMITTEE IV

International Map of the World,

World Aeronautical Charts and geographical names

The resolutions submitted by Committee IV, as amended, were adopted unanimously.

DRAFT RESOLUTIONS PROPOSED BY COMMITTEE V

Magnetic surveys and world magnetic charts; hydrography and oceanography

Mr. SINZI (Japan) proposed that the title of resolution C be simplified to mention only oceanography.

It was so agreed.

The draft resolutions submitted by Committee V, as amended, were adopted unanimously without discussion.

Draft resolutions proposed by the Working Group on Regional Organizations

The draft resolutions submitted by the Working Group on Regional Organizations were adopted unanimously without discussion.

Adoption of the report of the Conference

[Item 19 of the agenda]

Dr. TCHANG (Executive Secretary) explained that the draft report consisted of the text contained in document E/CONF 36/L 89 and all the resolutions adopted. He added that this provisional text would be completed taking into account the current proceedings and that the final editing would be done in accordance with the procedure and practice followed by the United Nations for official publications.

Mr. DIAS (Rapporteur) submitted the draft report for approval as a whole.

The report was adopted unanimously.

The meeting recessed at 3.40 p.m. and resumed at 3.50 p.m.

¹ Issued as E/CONF 36/SR 8.

Closing of the Conference

The PRESIDENT said that he considered it a great honour to have been in the Chair during the Conference and expressed his appreciation for the co-operation he had received from all the delegations, the Executive Secretary and the ECAFE secretariat, which had made his task so much easier.

He was confident that the understanding and friendship that had been brought about through the Conference would strengthen the bonds among the participating countries.

Rear-Admiral KARO (United States of America) felt sure he was speaking on behalf of all the delegates when he said that the Third United Nations Regional Cartographic Conference for Asia and the Far East had been a most memorable and constructive one. The groundwork had been laid for continuing the good work of the Conference throughout the coming years.

He expressed his appreciation to the host country for the excellent preparations, careful planning and leadership of the Conference, and he thanked, in particular, the President, the Executive Secretary and their most willing and competent staff.

Colonel SINHA (India) whole-heartedly supported the statement of the representative of the United States, and proposed a vote of thanks to the host country.

He also proposed a vote of thanks to the delegations representing countries outside the region, such as Canada, France, the Federal Republic of Germany, the Netherlands, the United Kingdom, the United States of America, and so on, without whose expert advice the Conference could not have achieved so much.

Captain PALMA (Philippines) supported the proposals of the representative of India.

The vote of thanks to the Government of Thailand and the delegations of countries outside the region was carried unanimously.

Dr. TCHANG (Executive Secretary), speaking on behalf of the Secretary-General of the United Nations, and on his own behalf, thanked the Government of Thailand for the excellent arrangement of the Conference. He also thanked the President and other officers of the Conference, the Chairmen of the Committees and all the delegates for their kind co-operation. He wished particularly to express his appreciation to the staff provided by the Government of Thailand for their untiring efforts.

The Third United Nations Regional Cartographic Conference for Asia and the Far East was closed on 10 November 1961, at 4.05 p.m.

Part II

TECHNICAL PAPERS PRESENTED TO THE CONFERENCE

AGENDA ITEM 6

Progress reports by countries on their respective cartographic activities since the last Conference

CARTOGRAPHY IN AFGHANISTAN¹

INTRODUCTION

Surveying and mapping activities in Afghanistan have lately achieved noteworthy progress and development ; the two main factors which should be emphasized in this respect are : first, the establishment of the Central Cartographic Institute, inaugurated in December 1957 ; secondly, the construction of a large modern building designed and built for the Institute. This building is to be completed in March 1962 and will have such conveniences as central heating, air-conditioned rooms, water supply system, etc.

ORGANIZATION

Since the inauguration of the Institute in 1957, great changes have taken place and efforts have been made to meet the urgent needs of the country. The national survey is principally the responsibility of the Afghan Cartographic Institute, which consists of the following : Geodetic Division, Photogrammetric Division, Topographic Division, Fair Drawing Division, Editing Division, Map Reproduction Division, Field Survey School and the Administrative Division.

GEODESY

As there is a great demand for larger-scale maps of the developed parts of the country, the establishment of first-order horizontal and vertical control stations is urgently needed to serve as a basis for all subsequent surveys.

The first geodetic base, seven kilometres in length, is being measured in the south of Kabul by classical methods and is expected to be completed in December 1961.

A reconnaissance has been made for a geodetic triangulation chain between Kabul and Kandahar, for which the observation will be started early next summer.

The establishment of precise vertical values of benchmarks along main roads and valleys is in progress and eventually the whole country will be covered by first-order levelling networks.

Afghanistan having no access to the sea, it has connected its levelling network with Russian datum, i.e., the Baltic Sea.

PHOTOGRAMMETRY

Although the Photogrammetric Division is not fully operating yet, it already has at its disposal the following

equipment: one Wild Autograph A5, one Wild Autograph A8, one SEG V and one photo laboratory completely equipped, one Zeiss camera 11.5/18, one radial secator and many mirror stereoscopes.

Aerial photography will be performed with the co-operation of the Royal Afghan Air Force under the supervision of Cartographic Institute personnel.

TOPOGRAPHY

To meet the immediate need of the Government's special agencies, maps of required areas will be prepared by ground survey methods using plane table and optical alidades.

The Topographic Division is now preparing for the field classification revision and completion of the 1:250,000 maps made by Fairchild Aerial Survey, Inc. of America. This job is expected to be completed by the end of 1962.

GEOLOGICAL MAPPING

A contract for nation-wide mapping was made with the Fairchild Aerial Survey Company on 31 August 1957. The project covers an aerial survey of the greater part of Afghanistan. The final aim is a series of photomaps at the scale of 1:100,000 and a topographic map at the scale of 1:250,000 with 100-metre contour intervals. The project will be completed by the end of 1962.

LAND RESEARCH SURVEYS

The Ministry of Agriculture is preparing land research and soil survey maps of specific areas; for this purpose the Cartographic Institute has provided the Ministry of Agriculture with adequately trained personnel.

CONCLUSION AND FUTURE PLANS

The Cartographic Institute, to meet urgent needs of the Government, will take active part in the realization of the second five-year plan. According to this plan, the parts of the country where mapping is needed should have 1:25,000-scale coverage and, furthermore, the more developed parts will be mapped at the scale of 1:10,000.

In order to achieve these goals foreign aid has been sought and contracts signed with the International Co-operation Administration (ICA) of the United States, according to which our needs and requirements have been fully surveyed, and a number of experts and the necessary equipment will be put at our disposal.

¹ The original text of this paper, submitted by Afghanistan, appeared as document E/CONF.36/L.78.

REPORT ON CARTOGRAPHIC ACTIVITIES IN AUSTRALIA¹

INTRODUCTION

The purpose of this report is to present a brief review of the general progress of mapping in Australia. It is not detailed, and if further information is required the reader is referred to the "Pictorial Index of Activities" prepared annually by, and obtainable from, the Director of National Mapping, Department of National Development, Canberra A.C.T., Australia.

The progress shown in this report is a consolidation of the work carried out under the guidance of the National Mapping Council of Australia, the chief contributors being:

1. Commonwealth Department of National Development;
2. Commonwealth Department of the Army;
3. The mapping agencies of the various State Surveyors General;
4. Commonwealth Scientific and Industrial Research Organization;
5. Commonwealth Department of the Interior;
6. Commonwealth Department of the Navy.

The text is brief, as it is believed that the maps included as annexes 1 to 6 will provide the reader with a reference which is more amenable to rapid review by cartographers than a voluminous text.

GEODETIC SURVEY

Australia

The geodetic survey of Australia has progressed to the stage shown in annex 1. This task, which five years ago bid fair to occupy the attention of our surveyors for generations, has progressed at a vastly increased speed, due to the introduction of electronic distance measuring equipment. The time is fast approaching when no point in Australia will be more than 150 miles from established geodetic control.

Referring to annex 1, the arrows show the location of current field activities.

Papua-New Guinea

The geodetic survey of this area has commenced, the ultimate aim being a chain of control through Papua-New Guinea on to New Britain, thence to the Solomon Islands.

Some beacons have already been established on the high mountains in the south, notably Mt. Yule, and reconnaissance data is being steadily accumulated. The crossing of Torres Strait is expected to be established during 1962.

Computations

Preliminary computations of the geodetic survey have been carried out using electric computing machines, and after investigation of the most suitable spheroid, it is proposed to perform the main computations on an electronic computer.

AERIAL PHOTOGRAPHY

Annex 2 shows graphically the existing aerial photography of Australia and Papua-New Guinea. It will be noted that the initial coverage of Australia is almost completed, and plans are in hand for the completion of the remaining portion at an early date.

The majority of this photography is at an approximate scale of 1:50,000, but recent photography and future planned work is at a scale of approximately 1:86,000. There are two distinct photography scales used:

1. For the use in preparing the National 1:250,000 Topographic Series, the scale 1:86,000;
2. For use in larger-scale mapping carried out by state authorities in the more intensely developed areas of the state, the scale 1:30,000.

Most of this 1:30,000-scale photography constitutes re-photography of areas previously flown at small scale for the National Topographic Series.

The introduction of the Wild RC9 super-wide-angle camera has proved very successful on the Australian mainland, and from a flying height of 25,000 feet, the resulting small-scale photography has speeded up the production of the National 1:250,000 Topographic Series maps.

Up to now, the Wild RC9 camera has not been used in Papua-New Guinea, as the very heavy relief of this territory (from sea level to 14,000 feet) makes the use of the super-wide-angle camera undesirable, and in this area the Eagle IX camera has been exclusively used.

MAP COVERAGE

Annex 3 shows the present position as regards map coverage. This chart refers specifically to maps produced from aerial photographs by the usual photogrammetric processes based on field survey control.

In addition to the National Topographic Series, other series at the scale of 1:1,000,000, such as the World Aeronautical Series, are compiled and published, and a regular programme of revision and publication of new editions ensures that all new mapping work is incorporated into the charts of such series.

The 1:250,000-scale maps of the National Topographic Series are being produced in two phases:

First phase. The production of a planimetric series at 1:250,000, printed in black, with relief shown by hill shading in brown. Production of this series is at the rate of sixty sheets, $1^{\circ} \times 1\frac{1}{2}^{\circ}$, each year, and on present progress the series should be complete by 1967;

Second phase. This phase contemplates the production of a series of maps at 1:250,000, in colour, fully contoured, and based on geodetic control. Commencement of this series will not await the completion of the first phase, but is in progress at the moment. However, only a small portion of the mapping resources is being devoted to this phase.

The proportion of effort will increase as the first phase nears completion.

The large-scale maps are for the most part being produced as contoured maps.

¹ The original text of this paper, submitted by Australia, appeared as document E/CONF 36/L 59.

In Papua-New Guinea the aerial photography is being processed to produce a 1:50,000-scale series. This work is under review at the moment to decide whether a series at a 1:100,000 scale would be more appropriate for this area.

GEOLOGICAL MAPPING

The geological mapping of the Commonwealth and Papua-New Guinea is drawn from two official sources, and also from private sources.

This mapping is shown in annex 4 and in recent years has received an increased stimulus as a result of the intensified search for oil. Private oil companies, who hold prospecting leases, have made a substantial contribution to the geological mapping.

Geophysical mapping has proceeded in conjunction with the geological mapping and large areas have been covered by air-borne magnetometer and seismic surveys.

REGIONAL AND SOIL SURVEYS

Surveys carried out by scientific and industrial research organizations can be broadly divided into two main categories:

1. Land research and regional surveys;
2. Soil surveys.

Annex 5 summarizes the position in respect to these surveys, which in general are designed to enable planned development of the more sparsely populated areas of the continent to take place.

KHMER GEOGRAPHICAL SERVICE¹

By Colonel Ngın Karet, Director, Geographical Service of Cambodia

The Khmer Geographical Service took part for the first time in the United Nations Regional Cartographic Conference for Asia and the Far East which met at Tokyo from 20 October to 1 November 1958.

The Service found that Conference very helpful from every point of view. It had at that time been in existence for only three years and needed the advice and, above all, the experience of other cartographic services so that it might expand rapidly and might undertake the compilation of precise and exact maps, which are needed with increasing urgency by the country's economy.

I am very pleased to be able to attend this Third Regional Cartographic Conference, which through its appositeness and the statements made by the distinguished representatives of various countries will enable me to solve some of our problems.

I thank the United Nations Economic and Social Council for its efforts to organize these conferences which are particularly helpful to the newer cartographic services and provide an opportunity for beneficial co-operation among the Asian and Far Eastern nations in the field of cartography.

The Khmer Geographical Service firmly believes that reliable cartographic information is an absolutely indispensable tool for the economic and social development of nations, and particularly of Cambodia where the Government has made and continues to make great efforts, at great financial sacrifice, to raise the level of living of its people.

Our Geographical Service is for this reason concentrating its efforts on the training of staff in all branches of the geographic sciences and on the acquisition of the new equipment needed in modern cartography.

Before 1955 the maps of Cambodia were compiled solely on the basis of ground surveys.

In view of the rapid economic and social development of Cambodia, the Khmer Geographical Service was

compelled to abandon its former *direct survey methods* of map making, which were slow and costly, and to adopt *photogrammetric methods* by which topographic maps can be prepared more rapidly and with greater precision. Such methods also have the advantage of being less costly and can be used throughout the year, even during the rainy season, with staff that does not have to be given as long or as intensive training as is required for direct surveys.

From 1958 onwards, the Khmer Geographical Service has made substantial efforts to develop its photogrammetry section.

In the matter of equipment, it has one Wild A7 with an automatic co-ordinatograph, two Kelsh plotters, two multiplex series, two Zeiss stereotopes and one Baush and Lomb rectifier.

It expects to obtain a Wild A8 and a Wild enlarger in 1962.

We think that with these instruments the Khmer Geographical Service will be able to satisfy within appreciably shorter periods of time a part of the large-scale map requirements of the public and private agencies concerned with the country's economic and social development.

The plotting staff is trained at Phnom-Penh by a United Nations photogrammetry expert in the use of the Wild A7 and stereotopes, and by a United States Army Map Service technician for the Kelsh and multiplex equipment.

Qualified photogrammetry technicians for our Service are being and will continue to be trained abroad.

A technician of the Service who has studied at the *École nationale des sciences géographiques* in Paris will be sent in October 1961 to Delft to take an eighteen-month course at the International Training Centre for Aerial Survey, and another will be sent in December 1961 to the Department of Commerce at Washington, D.C., to take a photogrammetry course at the Coast and Geodetic Survey.

At present the Khmer Geographical Service has the following maps:

¹ The original text of this paper, submitted, in French, by Cambodia, appeared as document E/CONF.36/L.67.

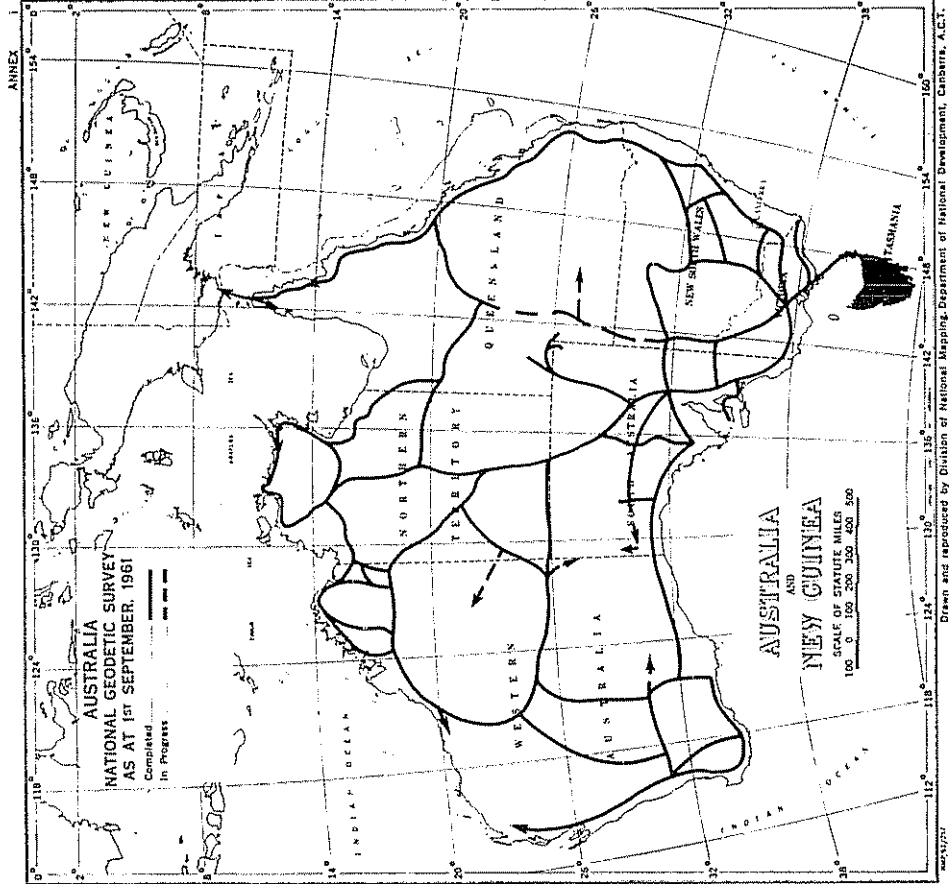

Figure 1. Australia: National geodetic survey as at 1 September 1961

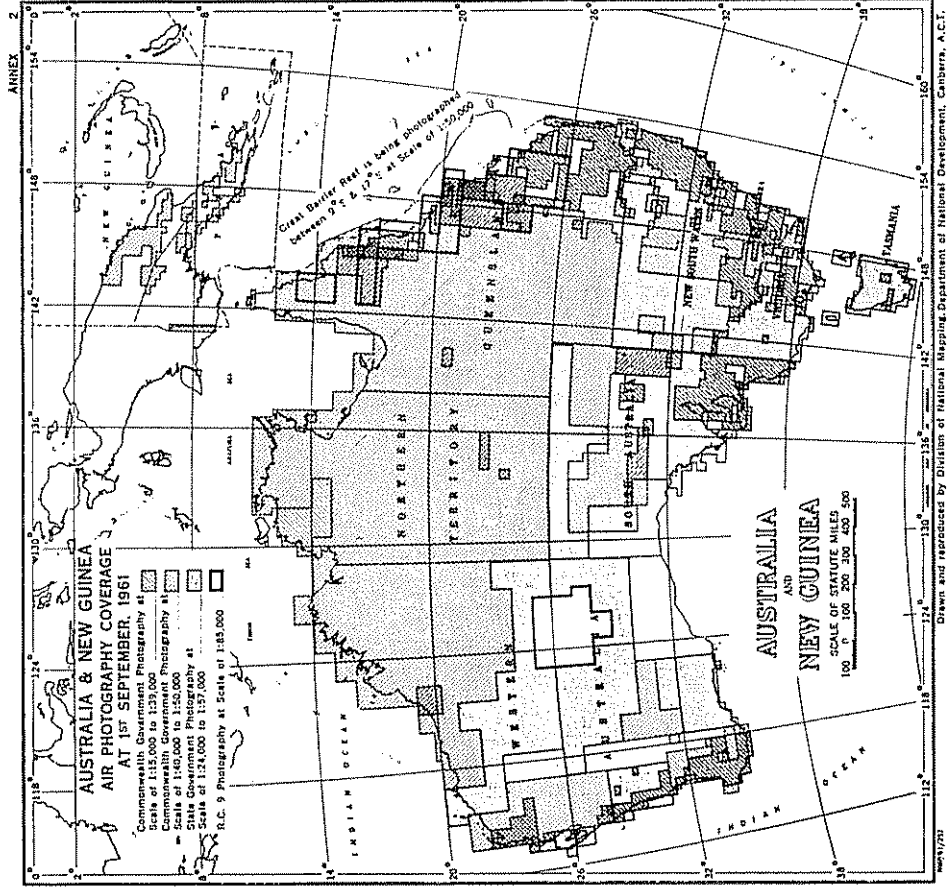

Figure 2. Australia and New Guinea: Air photography coverage as at 1 September 1961

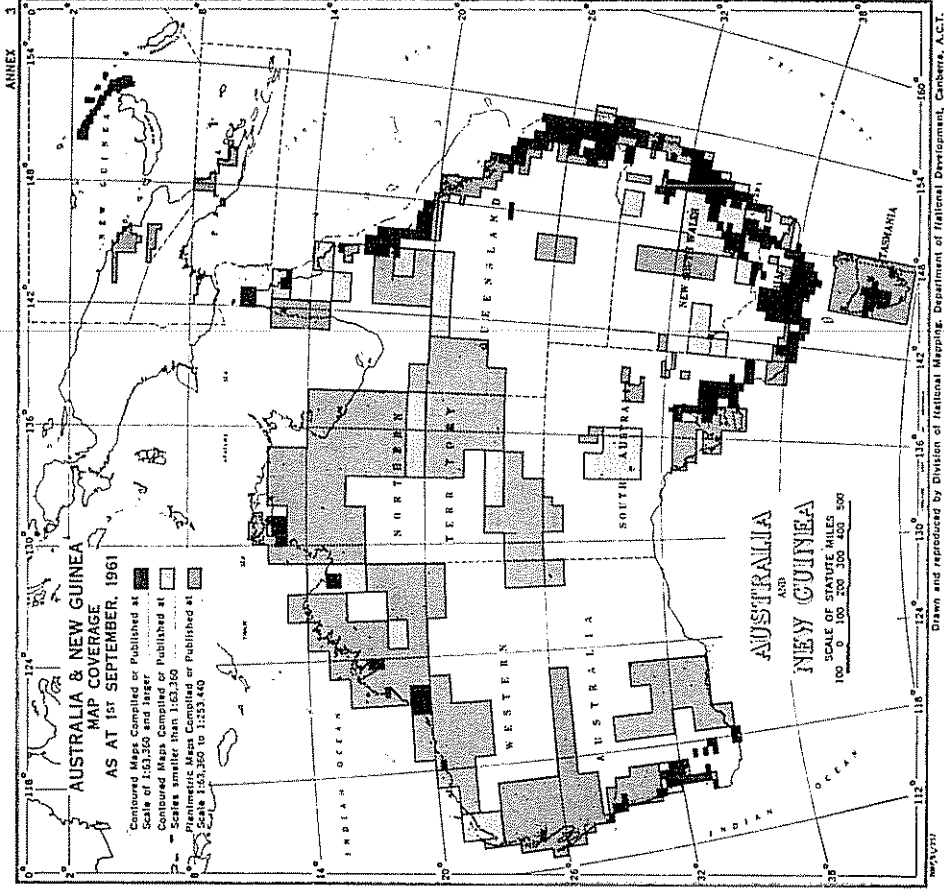

Figure 3. Australia and New Guinea: Map coverage as at 1 September 1961

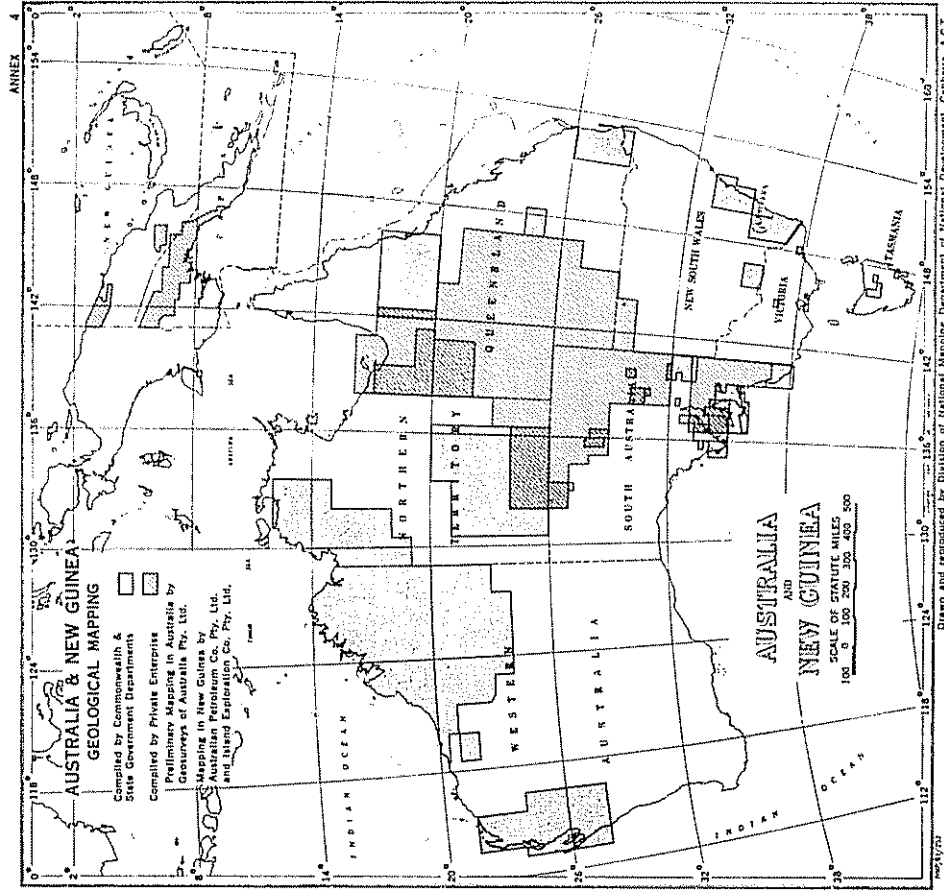
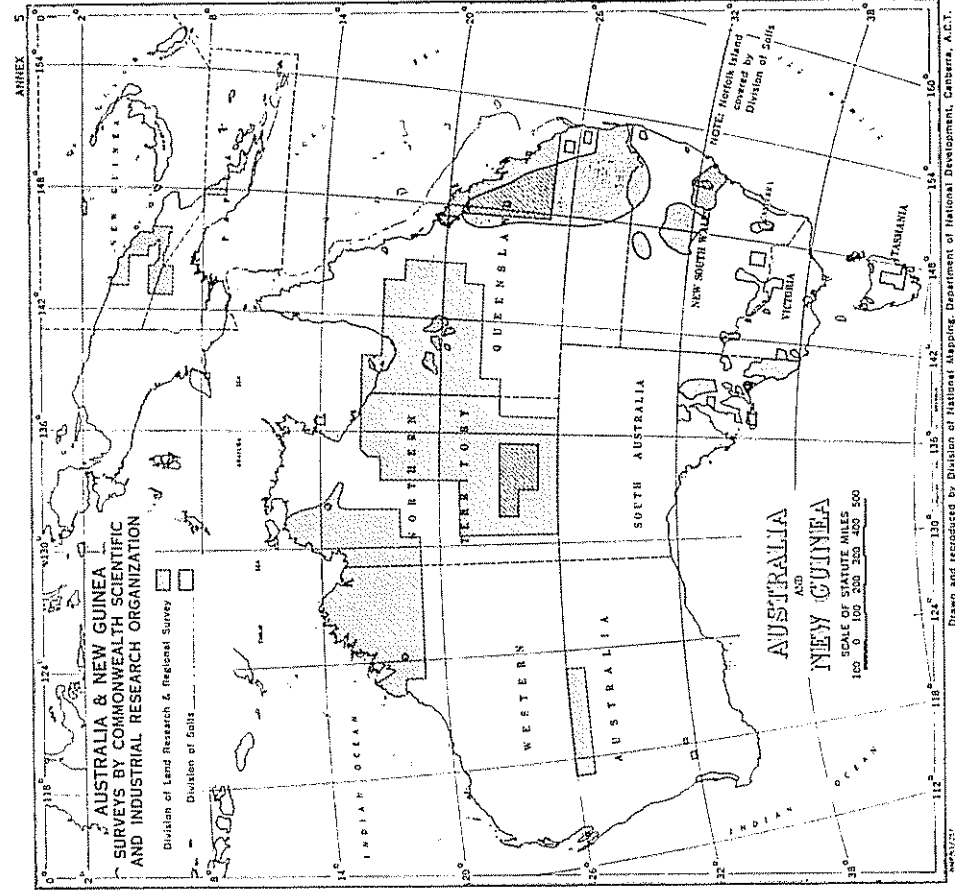
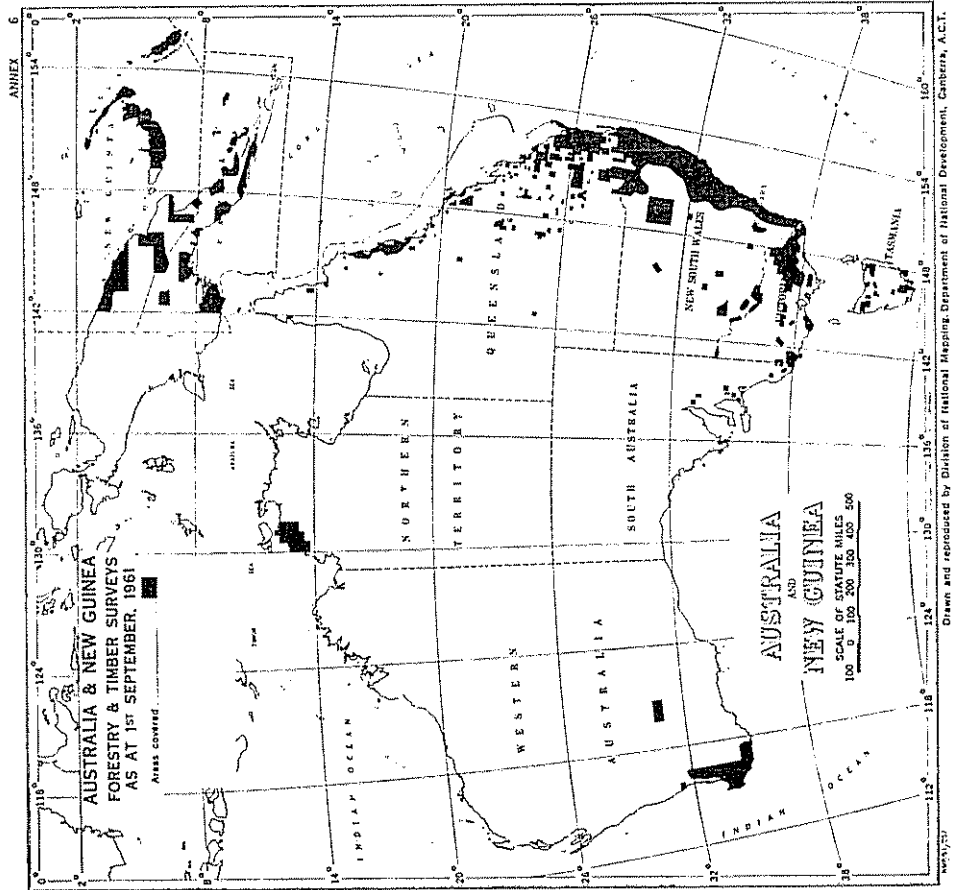

Figure 4. Australia and New Guinea: Geological mapping



Drawn and reproduced by Division of National Mapping, Department of National Development, Canberra, A.C.T.

Figure 5. Australia and New Guinea:
Surveys by the Commonwealth Scientific and Industrial Research Organization



Drawn and reproduced by Division of National Mapping, Department of National Development, Canberra, A.C.T.

Figure 6. Australia and New Guinea:
Forestry and timber surveys as at 1 September 1961

Administrative maps on the scale 1:500,000;
 Road maps on the scale 1:400,000;
 Road maps on the scale 1:250,000;
 Ordnance survey maps on the scale 1:100,000.

These maps are printed at the Printing Shop of the Khmer Geographical Service.

The United States Army Map Service, Far East, at Tokyo, is now compiling maps on the scale 1:50,000.

The Khmer Geographical Service is planning maps on the scale 1:10,000 for various urban centres and for some heavily populated areas.

The Khmer Geographical Service was established in 1955 and was placed under the Department of National Defence on 9 June 1956. Its formal title is: Office of the Geographical Service of the Khmer Royal Armed Forces (SG/FARK). It is organized as follows:

A. Financial and Administrative Division

This comprises two sections:

(a) *Financial Section*: responsible for preparation of the budget, purchase of supplies, sale of maps, payment of wages and salaries, and various accounting tasks;

(b) *Administrative Section*: responsible for recruitment and training of staff, library services, and arrangements for training abroad.

B. Cartography Division

This comprises two sections:

(a) *Drafting Section*: responsible for the drawing of maps on various scales, and the projection of maps with *Zeiss camerae lucidae*.

The Drafting Section expects to start drawing maps on plastic material in the near future. Two draughtsmen, who have taken advanced courses at the Geographical Survey Institute at Tokyo, are currently experimenting with this new method (negative scribing);

(b) *Reproduction and Printing Section*:

(1) *Zincography Sub-section*: responsible for the touch-up of zinc plates;

(2) *Photoprinting Sub-section*: responsible for producing the drawings on zinc plates;

(3) *Printing shop*.

Single-colour offset presses are used;

(4) *Binding and Printing Sub-section*.

C. Geodesy and Precise Levelling Division

This comprises three sections:

(a) *Geodesy Section*: responsible for first, second and third-order triangulation. Equipment used by this section: Wild T3, Wild T2 and tellurometer;

(b) *Precise Levelling Section*: responsible for all precise levelling operations. Equipment used: Wild No. III level;

(c) *Computation Section*.

D. Topography Division

This comprises two sections:

(a) *Classification Section*: responsible for all field-completion operations;

(b) *Special Surveys Section*: responsible for all topographic operations requested by the various technical services.

E. Photogrammetry Division

This comprises five sections:

(a) *Photography Section*: responsible for the development, printing, reduction, enlargement and rectification of aerial photographs, and the printing of manuscripts (plans or diagrams).

The archives of aerial photographs, negatives, diapositives, positives, etc. are kept in this section;

(b) *Computation Section*: responsible for computing the co-ordinates of reference points, adjustment of aerial triangulations, auxiliary computations (drafts, relative numerical orientations, graphs, stereotope, tables, etc.);

(c) *Stereoscopic Ground Control Section*: responsible for the preparation of aerial triangulation, rectification, stereoplotting with the stereotope, preparation of diagrams and formulae for aerial triangulation, compilation of photomosaics, and interpretation of aerial photographs;

(d) *Aerial Triangulation Section*: responsible for numerical aerial triangulation with the Wild A7, graphical aerial triangulation with the multiplex and slotted-templet aerial triangulation;

(e) *Plotting Section*: plotting from aerial photographs, size 23×23 cm, $f = 6''$

Instruments	Map scale
Wild A7 autograph	Large
Kelsh plotter	All scales
Multiplex	Small
Stereotope	Small

A repair shop for precision instruments is attached to this section.

Although the Khmer Geographical Service is a military agency, its activities are now mainly directed towards the civil sectors (agriculture, cadastral surveys, rural works, public works, etc.), especially as all activities, both military and civilian, of the Cambodian people are directed towards the intensive development of the country's economy.

ACTIVITIES SINCE 1958

Triangulation

A supplementary second-order triangulation has been carried out in Siemreap Province with a view to the compilation of maps of the Angkor ruins on the scale 1:10,000, and in the town of Sihanoukville for the purpose of compiling a town planning map.

The geographical position of the Koh Rong Salem lighthouse at Kompong-Som has been determined by our Service.

Levelling

A high-precision, first-order levelling has been carried out from Phnom-Penh to Sihanoukville to Kampot to Phnom-Penh (550 kilometres).

A second-order levelling has been carried out by the Khmer Geographical Service in Battambang Province on behalf of the French surveying company that is working for the Committee for Co-ordination of Investigations of the Lower Mekong Basin.

Topography

Surveyors of the Khmer Geographical Service have marked out streets in the new chief towns of Koh Kong and Ratanakiri Provinces.

Map Drawing

The following maps have been drawn:

Map on the scale 1:1,000,000;
Map on the scale 1:500,000;
Map on the scale 1:400,000.

Some maps on the scale 1:100,000 have been published; these comprise the sheets for Voeunsai, Attopeu, Yali and Stung Trèng.

Photography

The following operations have been performed:

Rectification of aerial photographs on the scale 1:4,000 for the Cadastral Survey Service;
Printing of aerial photographs for the technical services (Cadastral Survey, Water and Forests, Agriculture, Rural Works).

REPORT ON CARTOGRAPHIC ACTIVITIES OF THE CEYLON SURVEY DEPARTMENT¹

The National Map of the country on the scale 1:63,360 (one mile to an inch) with fifty-foot contour intervals was completed and published several years ago. The sheets of the Map are kept up to date by field revision at ten-year intervals and at even shorter intervals in areas of rapid development.

The other duties of the Survey Department are the production of large-scale plans for various government departments, for the settlement of crown title to land, for the parcelling of land for colonization schemes and land development, for the acquisition of the land for public purposes, such as public buildings, roads, power line routes and irrigation engineering projects. The latter takes up most of the resources of the Department.

Since the last United Nations Regional Cartographic Conference for Asia and the Far East, an Air Survey Branch was set up as a new unit of the Survey Department with the object of adopting air survey methods for the production of large-scale topographical maps and natural resources survey maps.

A Beechcraft air survey plane equipped with an RC8 camera had training flights in 1959 and started taking aerial photographs of special areas for photo studies for different government departments. The photo laboratory, having among other equipment a logetronic printer and a SEG V rectifier, began to function about the same time.

The Photogrammetric Section, equipped with one Wild autograph A7, two Wild autographs A8, two Kelsh plotters and several other smaller items, began its operations and training in 1959. In the course of training, several small scattered forest areas were mapped for water reservoir projects on the scale of 1:9,504 (twelve chains to an inch) with twenty-foot contour intervals, using 1:40,000 photography. Due to heavy forest cover, the machine contouring had to be controlled by providing the operator

with additional heights data. Even with this provision, which is quite costly, it is doubtful if the contours would satisfy the precision requirements of the irrigation engineers for whom this work is being done. Contouring in forest areas is difficult and in the future a combination of ground survey and photogrammetric methods will have to be used.

One of the main objectives of the Department is the production of a National Map on the scale of 1:12,672 (sixteen chains to an inch) with twenty-foot contour intervals, as the earlier map on the scale of 1:63,360 with fifty-foot contour intervals was found inadequate for modern needs. Several sheets of this series were plotted using 1:40,000 photography and the results were very satisfactory. As the work extends to forest-covered areas, contours may have to be depicted in pecked lines to indicate their uncertainty.

The mapping of towns on the scales of 1:792 (one chain to an inch) and 1:1,584 (two chains to an inch) for assessment and town planning purposes, using photography on the scales of 1:8,000 and larger, are under test plotting. Roof overhang and a poor definition of diapositives present difficulties. Single image photogrammetry is envisaged as a temporary solution to meet the urgent need for maps of several fast developing towns in flat areas.

A Resources Survey Section is about to be set up, with a nucleus of three officers who have recently returned from abroad after training at the International Training Centre, Delft, for the production of maps of special areas delineating geology, soils, forestry, land use, etc.

The Survey Department has its own Map Reproduction Section, which is capable of handling all the work in the Department and some of the work of other departments.

There is no Hydrographic Section as yet in the Department but it is hoped that one will be organized in the near future.

PROGRESS OF CARTOGRAPHIC WORK IN CHINA²

This report summarizes the cartographic work carried out in China during the period 1958 to 1960.

GEODETIC WORKS

Readjustment and recomputation of all triangulation stations on the China mainland

In order to revise and recompile all the maps of China, readjustment of all the triangulation stations of the differ-

ent orders in the different provinces on the China mainland has been made in recent years. The geographical co-ordinates of all the stations were recomputed on a single geodetic datum and the elevation is based on mean sea level. This work is so complicated that several years have been spent on it. The closures of the loop adjustment are not more than ten seconds. Completion of the whole work is expected at the end of this year (1961).

¹ The original text of this paper, submitted by Ceylon, appeared as document E/CONF.36/L.82.

² The original text of this paper, submitted by China, appeared as document E/CONF.36/L.64.

MAP OF CAMBODIA

AREA COVERED BY AERIAL PHOTOGRAPHS AT THE SCALE 1:10,000

1958-1959 MISSION

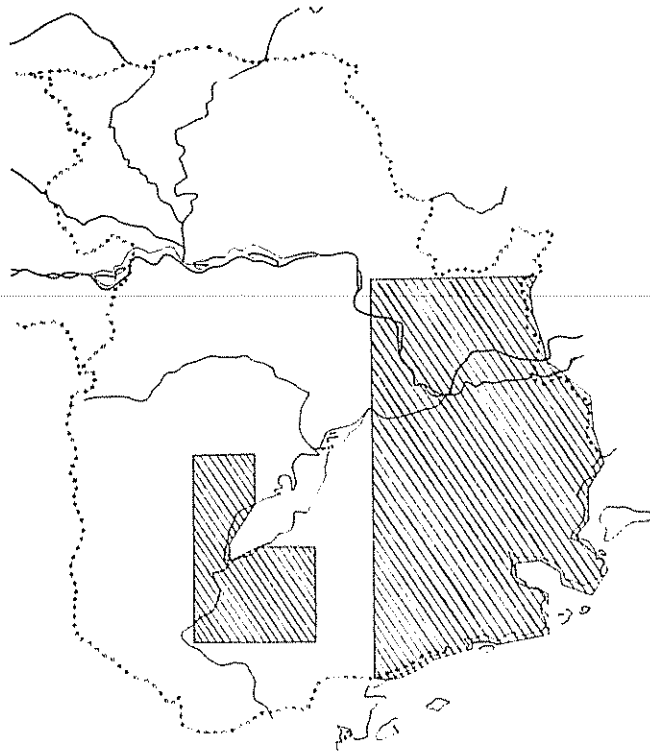

LEGEND



Area covered by aerial photographs at the scale 1:10,000

AREA COVERED BY AERIAL PHOTOGRAPHS AT THE SCALE 1:40,000

1957-1958 MISSION

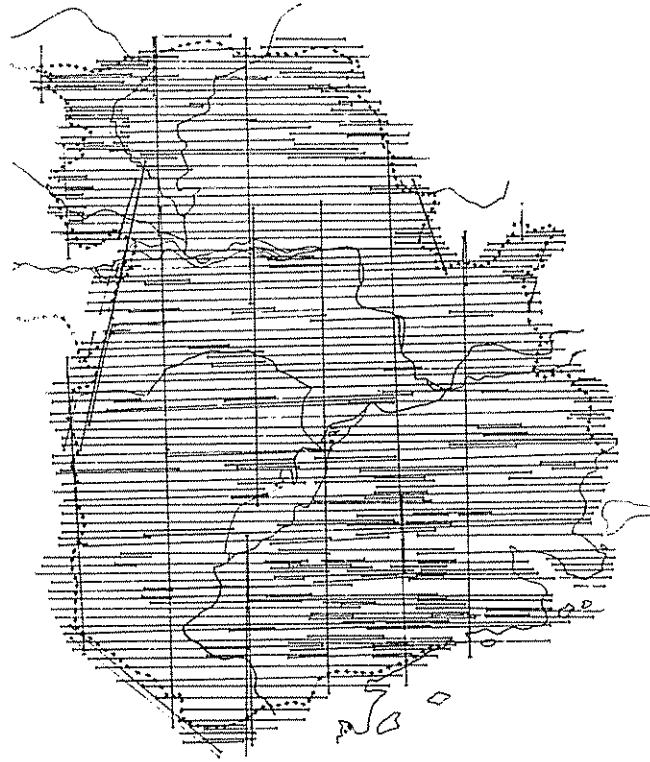

MAP OF CAMBODIA



Figure 7. Cambodia: Area covered by aerial photographs on the scale 1:10,000, 1958-1959 mission

Figure 8. Cambodia: Area covered by aerial photographs on the scale 1:40,000, 1957-1958 mission

MAP OF CAMBODIA
AT THE SCALE 1:50,000
NOW BEING COMPILED

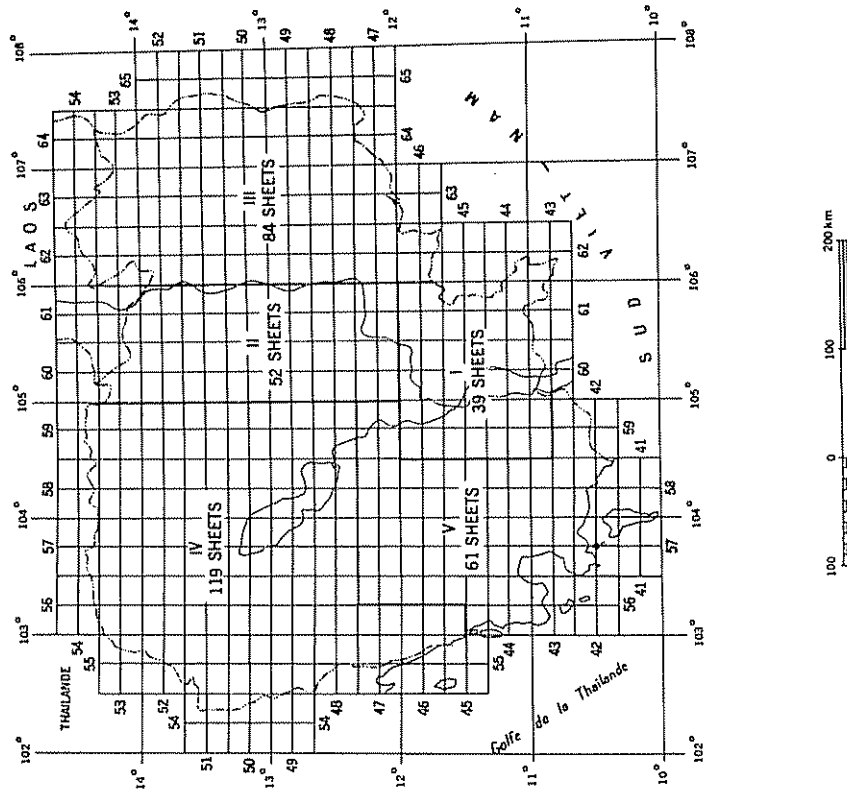
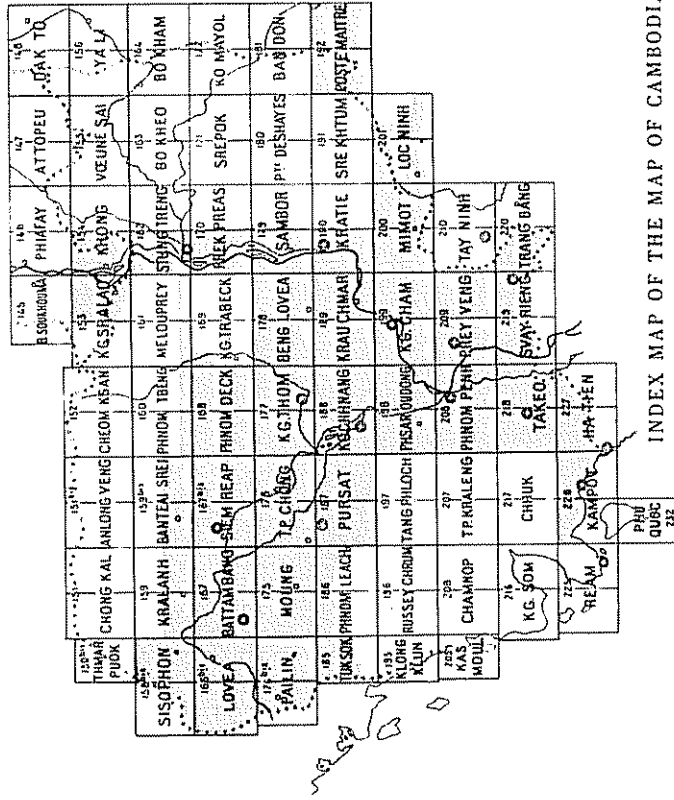

Figure 9. Map of Cambodia on the scale 1:50,000 now being compiled

Regular maps
Photo-mosaic



INDEX MAP OF THE MAP OF CAMBODIA
AT THE SCALE 1:100,000

SHEET AT THE SCALE 1:100,000
(two map-sheets)

Sheet number
Sheet title

217
CHHUK

100 0 100 200 km

Fig. 10. Index map of the Map of Cambodia on the scale 1:100,000

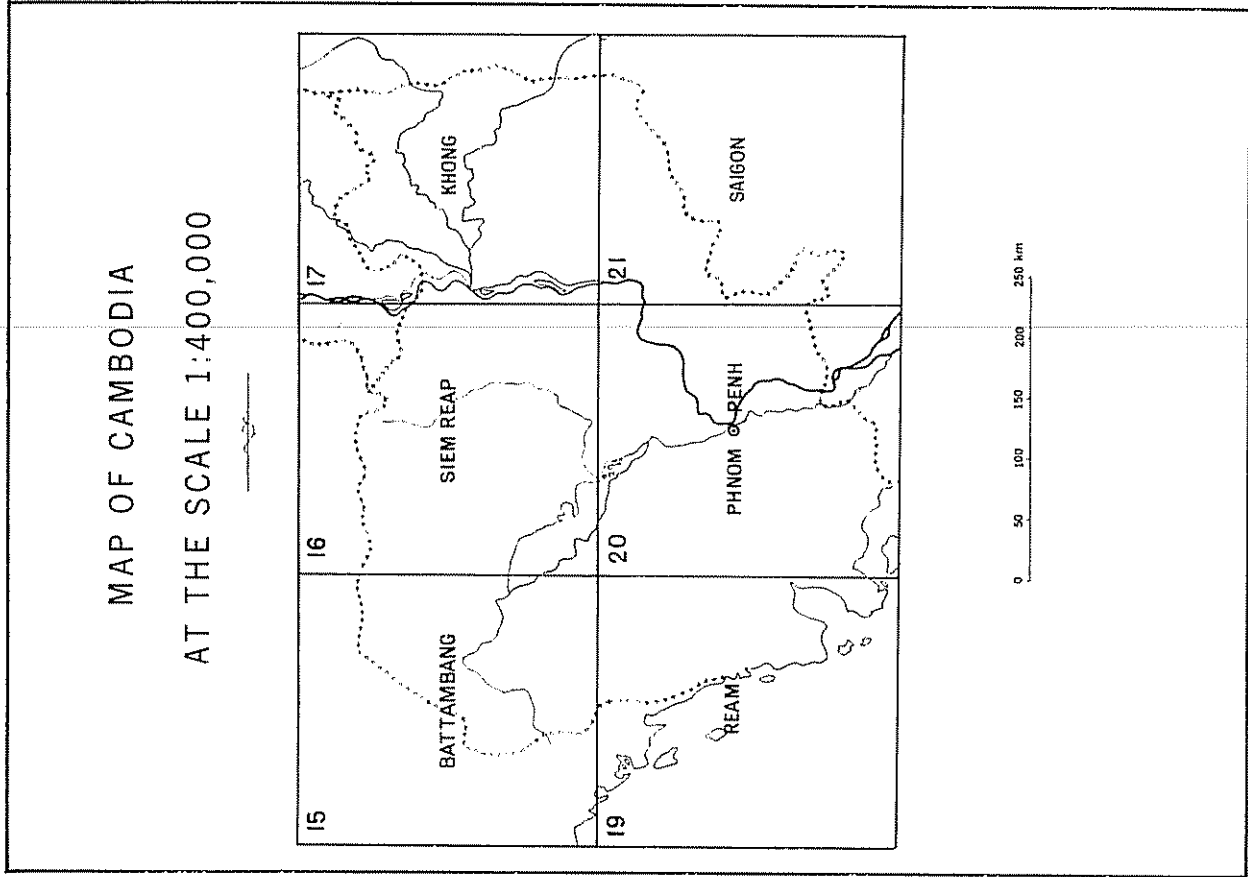

Figure 11. Map of Cambodia on the scale 1:400,000

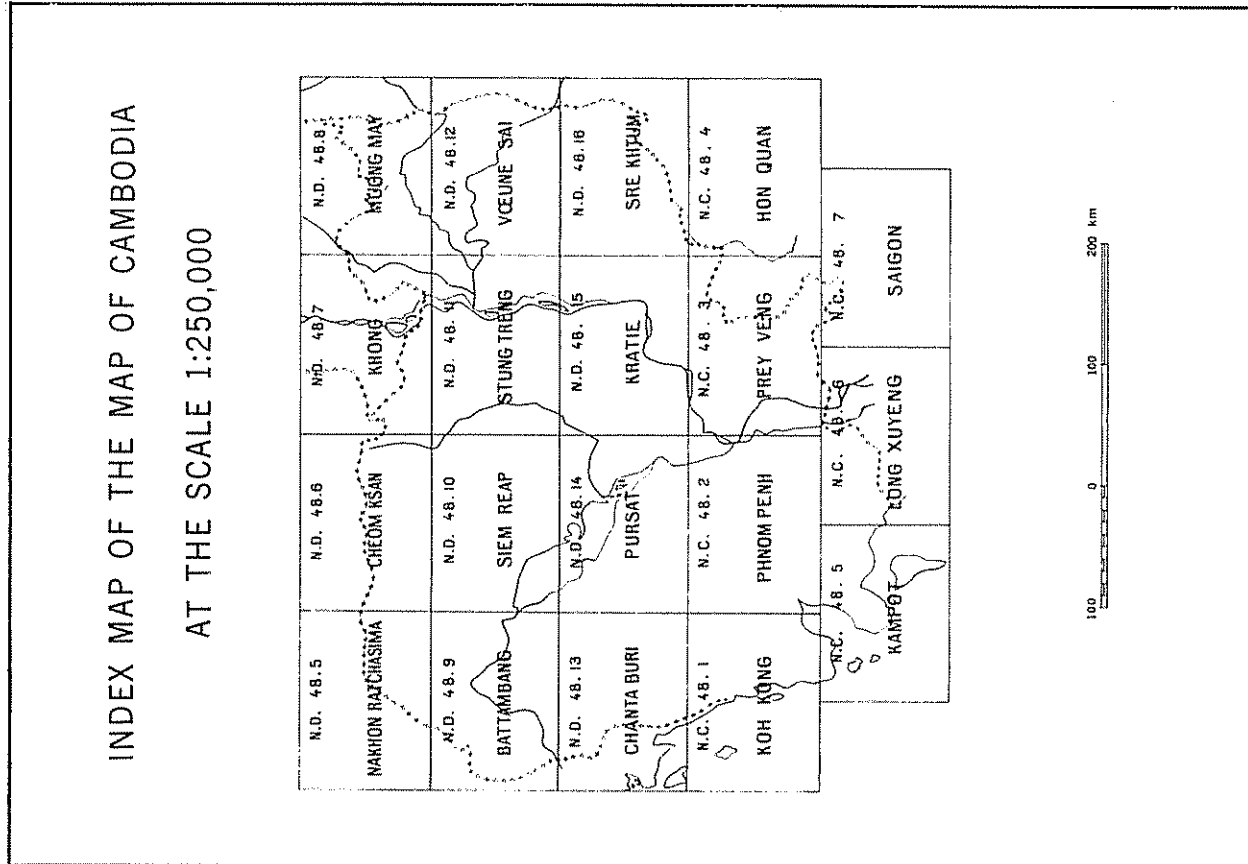

Figure 12. Index map of the Map of Cambodia on the scale 1:250,000

Geodetic tie between the China mainland and the islands off the south-east coast of China

Some independent triangulation nets and astronomical stations were established on the islands off the south-east coast of China. But these stations were not tied together on a common datum. In 1958 several stations on the adjacent islands were established, using the tellurometer. It is expected that the data obtained can be used for the connexion and readjustment of the triangulation stations on the islands off the south-east coast of China.

Deflection of the vertical

In order to find the deflection of the vertical in the triangulation systems of Taiwan, some Laplace points were observed from 1953 to 1959. The accuracy of the results obtained is about twenty seconds in longitude and two seconds in latitude.

Occultation observations

During the three years seventeen stations were observed with the twelve-inch Cassegrainian apparatus.

Gravity observations

Besides the gravity observations for the exploration of petroleum in Taiwan, another programme for geodetic purposes has been carried out recently. About one hundred stations have been selected, which include base station and base reference stations. The LaCoste and Romberg model G geodetic gravity meter has been used for the observations. Up to the end of September of this year, fifty-two stations had been occupied. The programme is scheduled to be completed at the end of this year; the international connexion will be made next year.

TOPOGRAPHY AND AERIAL PHOTOGRAMMETRY

Efforts have been concentrated on the revision of existing maps of China in order to bring them up to date. About 250 sheets of the 1:25,000-scale, 450 sheets of the 1:50,000-scale and 200 sheets of the 1:250,000-scale topographic maps have been revised and reproduced in multicolour with a grid system. Surveys for large-scale topographic maps, such as those on the scales of 1:5,000, 1:6,000 and 1:10,000, have been completed also in some areas of Taiwan and the adjacent islands. Besides field works, aerial photographs and photogrammetric plotting instruments, such as multiplex, KEK plotter and sketchmaster, have been used with a view to attaining economy, speed and accuracy.

Aerial photogrammetric methods have also been extensively adopted for land use and forest resource surveys in Taiwan. This subject is presented in a separate paper² to this Conference.

PHOTO-INTERPRETATION

The methods and techniques of photo-interpretation have been used quite extensively in Taiwan. The application of aerial photography to forestry and land use was first adopted by the Joint Commission on Rural Rehabili-

tation. After some experiments, the economic interpretation of aerial photographs for the study of natural resources was used by the Taiwan Agricultural and Forestry Air Survey Team and the Taiwan Agricultural Research Institute. A booklet of stereograms of the different kinds of trees in Taiwan was composed which can be used as an interpretation key of the trees grown in Taiwan.

In 1960, a photogeologic training class consisting of fifteen students was held. The training period was three months. The class was sponsored by the Geological Survey of Taiwan and the Chinese Petroleum Corporation. In addition to forestry and land use, photo-interpretation is now also being used in geology and in the exploration for petroleum.

The Chinese Society of Aerial Photogrammetry is planning to open a photo-interpretation course in universities in Taiwan.

MAP COMPILATION AND REPRODUCTION

IMW and ICAO WAC

Eight sheets of the IMW and two sheets of the ICAO WAC covering the area of China have been recompiled and published in multicolour since the last Conference.

Tentative specifications for international 1:1,000,000 general maps of China have been drafted and are presented to this Conference as a separate paper.³

Administrative maps of Taiwan

Twenty-four sheets of administrative maps of Taiwan have been compiled and published in multicolour, the scales of which vary from 1:15,000 to 1:300,000.

Negative scribing

Negative scribing has been adopted in colour-separation work, and scribing instruments are now available in Taiwan.

Relief maps

Some plastic relief maps on the scales of 1:50,000, 1:250,000 and 1:1,000,000 have been reproduced by the vacuum forming method, using thermoplastic material as a reproduction medium.

GEOGRAPHICAL NAMES

The Government has been trying hard uniformly to standardize geographical names. In 1945, the Committee for the Unification of Transliterated Chinese and Foreign Geographical Names was established to study the problem. Except in the border regions, geographical names in most parts of China are being standardized uniformly with romanized spelling.

A gazetteer consisting of all the geographical names appearing in the 1:50,000-scale maps of Taiwan and those of a part of the Chinese mainland has been published in Chinese with romanized spelling. In addition, 8,504 important foreign geographical names have been transliterated into Chinese.

² See "Land use and forest resource survey in Taiwan", reproduced in the present volume under item 14 of the agenda.

³ See "Tentative specifications for international 1:1,000,000 general maps of China", reproduced in the present volume under item 17 of the agenda.

REPORT ON CARTOGRAPHIC WORK IN THE FEDERAL REPUBLIC OF GERMANY¹

The Federal Republic of Germany, since it does not belong to the area of Asia and the Far East, has not prepared a special report on its cartographic activities, but it might be interesting to note that a country with more than 150 years of cartographic experience and activity still has work to be done in the cartographic field.

The triangulation network has been completed. Observations of astronomic stations, base lines and a few first-order stations are only carried out for scientific purposes. The existing triangulation is good enough for all practical purposes, although the readjustment of the European network, a scientific task of the International Association of Geodesy, required some additional measurements.

The levelling network has also been completed. Measurements are repeated only in the northern part of Germany every twenty years in order to study the movement of the earth's crust.

Work on the basic map of the Federal Republic on the scale of 1:5,000 is still under way. Maps on the scales of 1:25,000, 1:100,000, 1:200,000, 1:500,000 and 1:1,000,000 have been completed. The map on the scale of 1:25,000 has been completely revised. A new map on the scale of 1:50,000 will be completed within three years. A new edition and a complete revision of the map on the scale of 1:100,000 has been started. In addition, a new map on the scale of 1:2,000,000 and other series on smaller scales are in preparation.

The geodetic and cartographic work in the Federal

Republic is done by the State Survey Offices in each of the ten states of the country. The Federal Government finances only the Institute of Applied Geodesy, which is responsible for all kinds of research work in geodesy and cartography and which produces small-scale maps (1:200,000 and smaller).

In connexion with international scientific projects, much work has been done including co-operation in the observation of eclipses. During the International Greenland Expedition, the observation of the trilateration chain through Greenland from the western to the eastern coast was carried out within four months with tellurometers. The chain had quadrangles with sides ten kilometres in length. The diagonals were also observed. The measurements will be repeated within ten years to determine the movement of the ice.

In co-operation with Austria and Switzerland, a test network for electronic instruments was established in the Rhine Valley in Switzerland. A base line, six kilometres in length, measured with invar wires, was enlarged by a base network to distances of about twelve, twenty, thirty-five and fifty kilometres to permit tests of all kinds of electronic equipment to be made with very high precision.

An astronomic levelling operation is being carried out following a meridian. A gravity network of first and second order has already been completed.

This short résumé may illustrate that cartographic work is never completed and that there are always new problems arising which require intensified activity in cartography.

REPORT ON THE CARTOGRAPHIC ACTIVITIES IN INDIA FOR THE PERIOD 1958-1961²

INTRODUCTION

Topographical and marine surveys in India are chiefly carried out by the Survey of India and the Hydrographic Branch, the former being responsible for all photogrammetric and ground surveys, mapping and printing, the latter for hydrographic surveys and mapping only. In addition, most of the states of India have their own cadastral survey organizations. There is only one company in India which is run on a commercial basis, Air Survey Company of India (Private), Ltd.

The Survey of India, having decided to switch over to the metric system and having economic development as its object, has found that its cartographic activities have increased considerably. Although the capacity to expand is limited and comparatively slow, progressive automation and mechanization, commensurate with our national policy of finding employment for the unemployed, have been the keynote of our increased activities.

GEODESY

(a) Establishment of a Väisälä base in India had been sponsored by our delegates at the first United Nations

Regional Cartographic Conference for Asia and the Far East. At present we are much involved with various projects in connexion with the five-year plan, and we are, therefore, not in a position to take an active part in the establishment of such a base in the country.

Instruments have since been developed, such as the Electrotape, and the most recent Distomat, which are capable of geodetic accuracy in linear measurements. We are trying to procure some sets of these and hope to check on some of our base lines which were measured by conventional methods. Statistical analysis of the numerous comparisons, it is felt, will help materially to bring about an internationally accepted value for the velocities of propagation of light or electromagnetic waves and for the most suitable atmospheric corrections to be applied for survey purposes.

(b) Establishment of a world-wide geodetic network and the connexion between continents and significant islands are desirable but at present we are heavily committed on departmental and project surveys. The conventional method of star occultation by the moon, considered at the Tokyo Conference, is possibly practical and economical; however, artificial satellites like the geodetic

¹ The original text of this paper, submitted by the Federal Republic of Germany, appeared as document E/CONF.36/L.87.

² The original text of this paper, submitted by India, appeared as document E/CONF.36/L.69.

satellite of the United States of America, using the SECOR (Sequential Collation of Range) may possibly provide a better means to achieve such connexions.

(c) Each country has its own standards and terminology. In India we have three categories, i.e., primary, secondary and tertiary (or minor) with minimum accuracies of from 1:100,000 to 1:50,000, respectively. We have not carried out extensive primary traverses, but secondary traverses have yielded an accuracy of 1:5,000 or more. The geodetic triangulation carried out in India has actually yielded an accuracy of 1:500,000.

We may not at present find so much necessity for classification in each category since our land values have not been developed as in other countries, but there is no harm in having the various classifications from the beginning. This matter could be better discussed and dealt with at the meetings of the International Union of Geodesy and Geophysics.

(d) The maintenance of a National Standard Magnetometer is desirable and calibration of field instruments against this standard is necessary before the commencement of observations. At present our magnetometers are calibrated at Alibag. Our static observatory at Sabhawala (Dehra Dun) which is equipped with La Cour's magnetometer and Askania's earth variograph will soon start functioning. The calibration of the National Standard against the International Standards is felt desirable.

Action is at hand to procure proton-precession magnetometers along with other magnetic instruments. We hope to participate in the Indian Oceanic Research Expedition for magnetic surveys at sea during the minimum sun spot activity period from 1962 to 1964.

(e) International gravity connexions between the world stations, i.e., the one at New Delhi and the four adjacent stations of the first-order world network in Tokyo, Singapore, Beirut and Khartoum, may be carried out with the co-operation of the countries involved. However, we are not in a position to carry this out due to our difficult foreign exchange situation.

We also do not have any of the modern pendulum apparatuses, such as the Brown Invar apparatus, the Cambridge Invar apparatus or the Gulf-Woollard apparatus. If funds are provided for such instruments, personnel could be made available for observations.

At present we have to depend on gravity meter calibrations made when other agencies from abroad connect our stations (by both pendulum and gravity meter).

Our Delhi station has been periodically connected by foreign observers. Most recently (August 1961), Dr. Sankar Narayan, working under Dr. Woollard of Wisconsin University, made gravity ties between several fundamental stations, including Teddington.

The extension of gravity observations in the neighbouring seas, i.e., Bay of Bengal, Arabian Sea and Indian Ocean, is desirable particularly in view of the fact that the land portions of our country have been fairly well covered by such observations. Due to lack of proper instruments and a vessel, we are not in a position to undertake this task, but we can spare a few technical personnel if the instruments, vessel and necessary funds are provided. This may be arranged for participation in the Indian Oceanic Research Expedition taking place in 1962.

We plan ultimately to have a ten-mile network of gravity stations throughout India. We also intend to determine the gravimetric deflections of the plumb-line at and near the national geodetic origin.

(f) During the current IGY/IGC programme special observations were carried out, such as earth-tides by the gravimetric method, variation of latitude and longitude observations by the Wild Universal T4, Zenith telescope and transits. Observations were also carried out for the first time in India for tidal streams in certain gulfs and estuaries. The data are under analysis for the preparation of an Atlas of Tides and Tidal Streams for Indian Waters.

We have already acquired a Danjon astrolabe and Belin's chronograph. Observations will commence as soon as we are able to purchase crystal clocks and the observatory building is constructed.

A Photo Zenith Tube will be obtained in the near future.

Action is at hand for the procurement of an electronic computer for survey computations.

TOPOGRAPHICAL MAPPING AND PHOTOGRAMMETRY

General

The general situation in the field of topographical mapping and photogrammetry has changed little from that which existed three years ago. There are, however, developments under way which will affect the general topographical mapping and photogrammetry within the next few years. The methods that have been used during the period 1958 to 1961 and those which are likely to be introduced in the near future are dealt with briefly.

Aerial photography

In India, both normal and wide-angle cameras are used for taking aerial photographs on various scales ranging from large to small, i.e., from 1:6,000 to 1:50,000, while distortion-free modern cameras, such as the Wild RC5a, are used for large-scale precision surveys and the Eagle IX for surveys and various project and flood control investigation surveys of less accuracy. The distortion of the Eagle IX camera is compensated for either by using a transformation printer Zeiss reductor, or by using correction plates in the ratio printer while preparing diapositives or contact prints, or in the stereoplotting instruments at the time of plotting. The major portion of India's aerial photography is flown by the government agency of the Indian Air Force and the balance is flown by the Air Survey Company of India (Private), Ltd. The photographic quality is of average standard. Navigation throughout is carried out by visual methods.

Topographical mapping

Use of third-order photogrammetric instruments for compilation of geographical maps

In India, the geographical maps drawn on scales of 1:1,000,000 or smaller are compiled from the existing topographical maps. The whole of India is covered by a series of accurate topographical maps on the scale of four miles to one inch (1:253,440) which are used for the compilation of geographical maps and thus the necessity for using third-order photogrammetric instruments for compilation of geographical maps does not arise in India.

Recent developments in photogrammetric plotting instruments

India possesses a variety of photogrammetric equipment, e.g., first-order universal instruments, first-order and third-order plotters. The first-order universal instruments are normally used to supplement planimetric and height control data from spatial aerial triangulation, and for the plotting of very large-scale plans necessitating photo to map enlargements of from five to eight times. The first-order plotters are used for the plotting of medium and large-scale maps, e.g., 1:4,000, 1:5,000, 1:10,000, 1:15,000 and 1:20,000, with contour intervals ranging from five feet to ten feet for the various development projects requiring photo to map enlargements of four times or less. The third-order instruments are employed for plotting topographical maps on scales 1:25,000 and 1:50,000, with contours at ten and twenty-metre vertical intervals. Thus, there exists a definite gap in our chain of photogrammetric instruments caused by the absence of second-order plotters. As a result, the survey of mountainous terrain on topographical scales has had to be carried out on the first-order plotters. We are trying to acquire some second-order plotters to fill this gap.

Automation in photogrammetry and its impact on map production

We in India have heard with interest of the Stereomat, the automatic stereoplotting device invented in Canada, which may well revolutionize future mapping techniques. This device, designed at present for the anaglyph projection-type instruments, performs the relative orientation of a stereoscopic pair, reads elevations, draws profiles in the stereomodel and draws contours automatically. It is expected that this device will in the near future be further perfected for use with the normal light transmission type of instruments. In that case, it is visualized that these automatic devices will be increasingly used for the rapid execution of relative orientation and for contouring at a speed ten to twenty times faster than the contouring performed by a human operator.

Use of camera orientation equipment

It is well known that the use of camera orientation equipment, such as horizon cameras, radar altimeters, statoscopes, gyroscopes and solar periscopes can reduce the quantity of ground control and increase the accuracy of long strips, especially in mountainous terrain. This type of equipment is necessary for the photogrammetric survey of photographs for small-scale topographical mapping. In order to carry out systematic research work on these lines, we propose acquiring some horizon cameras and statoscopes.

Adjustment of aerial triangulation

At present in India, we are carrying out graphical adjustment of short strips of spatial aerial triangulation by Zarzycki's second-order graphical interpolation methods. Due to the limited precision of this adjustment method, we are compelled to restrict the strip lengths to about ten to fifteen stereoscopic models, necessitating a very dense network of ground control points. In order to effect economy in ground control points commensurate with high accuracy, we are acquiring the ITC-Jerie analogue computers for block adjustment. With the introduction of the block adjustment method, the process of topographical mapping is expected to be speeded up considerably.

Standards with respect to scales and accuracy for topographical map series

Though at present the smallest scale of photography used in India is 1:50,000, we are in favour of the use of super-wide-angle cameras for aerial photography for small-scale topographical mapping. A scale of photography at 1:70,000 to 1:75,000 is ideally suited for 1:50,000 or 1:100,000-scale mapping. While arriving at this scale, the underlying idea is that the scale of photography should be in accordance with the requirements of distinguishing the necessary topographical details on the photographs. With the super-wide-angle camera, the high-altitude flying necessary for small-scale photography can be avoided. Due to the greater coverage for overlap, the number of models and, consequently, the requirement of ground control will be much less, resulting in all-round economy of the photogrammetric method. For normal terrain we shall be using Zeiss stereotopes, whereas for mountainous terrain we propose to use Wild Aviograph B8 small-scale plotters.

For medium-scale topographical mapping, the scale of photography varies from 1:15,000 to 1:40,000 and, depending on the photo to map enlargements necessary, the mapping is carried out mostly with Wild autograph A8s and, in rare cases, with A7s.

For large-scale mapping on the scales of 1:1,000 to 1:25,000, the scale of aerial photography is kept between 1:6,000 and 1:15,000.

We have found that, as compared to ground methods, the use of photogrammetric methods results in higher output and greater accuracy.

Techniques and methods used in the production of various scale series of topographical maps

For the production of 1:50,000-scale topographical maps, the extension of planimetric control is accomplished by the slotted templet method using Zeiss radial secators. The extension of vertical control is obtained by spatial aerial triangulation for heights in universal analogue stereoplotting machines. The plotting of details and contours is carried out on third-order plotters, Zeiss stereotopes.

For the production of medium-scale topographical maps, the extension of both planimetric and height control is carried out by spatial aerial triangulation. The plotting of details and contours is carried out on first-order plotters Wild autograph A8s.

For the production of medium-scale maps of less planimetric accuracy but greater vertical accuracy, i.e., with contour intervals of one foot or two feet, the details are plotted on Zeiss stereotopes after the extension of planimetric control by slotted templet combinations. The contours are, however, obtained by interpolation from a mesh of spirit-levelled spot heights, which are identified and pinpointed on the aerial photographs.

For the production of large-scale maps, for example, sixty-four inches to one mile (about 1:1,000), sufficient planimetric and height control points necessary for the absolute orientation of each model are provided on the ground. For very small contour intervals, a network of machine-read spot heights are first provided and the contours are then plotted under stereoscopic vision.

Depending on the scale of mapping, terrain and the accuracy desired, the verification of aerial photographs before plotting or the blue print verification after plotting is carried out for the completion of the photogrammetric map.

Cadastral survey

The cadastral survey of India is at present being carried out by the state revenue authorities using ground survey methods. The present method of survey is slow and expensive and has to be gradually replaced by photogrammetric methods as soon as the state of training of personnel and instrumentation permits. At present, a move is afoot to connect all the cadastral survey with the existing national geodetic network of ground control.

PHOTO-INTERPRETATION AND TOPICAL MAPS

Introduction

Aerial photographs contain a wealth of information and by their proper interpretation many data regarding the economic and social development of the country can be derived. With the perfection of the technique of aerial photo-interpretation, aerial photographs have become a convenient tool of multiple uses for general economic purposes. The introduction of this technique in India, though delayed due to certain circumstances, has already gained considerable popularity.

Geographic evaluation of aerial photography

With the rapid increase of world population, agricultural productivity has also to be improved more and more. Any programme for raising agricultural productivity will require the production of soil maps and land use and land classification studies. A modest start in the use of aerial photographs for these purposes has been made in the Soil Section of the Indian Agricultural Research Institute at New Delhi. A progressive use of aerial photography in these branches is envisaged.

Use of aerial photographs for economic and social planning

Aerial photographs and photomosaics are being used in India for urban analysis and town planning on a limited scale. The success of this method is bound to lead to more frequent use of aerial photographs for these purposes.

Economic evaluation of aerial photographs with regard to topographical, geological and geophysical measurements

The economy of the use of aerial photographs for topographical mapping has been established in India beyond any doubt. For geological and geo-physical measurements, an equivalent increase in economy and speed can be expected as the cost of aerial photography constitutes a very small fraction of the cost of any development project. The systematic use of the same aerial photography for various purposes will result in over-all economy.

Topical mapping

For the economic development of a country's industry, the preparation of an inventory of its mineral resources is very important. Aerial photographs are being progressively used by the Geological Survey of India for the exploitation and utilization of mineral resources.

Forests form a very important natural wealth of our country and their proper exploitation and management is therefore equally important. Though aerial photo-

graphs have not so far been used by the foresters in India, a start is expected to be made very soon.

Soil erosion poses a serious problem in many of the already denuded slopes of the hilly regions and the soil conservation authorities have started using aerial photographs for planning of their soil conservation schemes.

We are sure that for each of the above uses, aerial photography, if used in the proper way, will greatly improve the economy of the procedure as well as result in the early completion of a comprehensive inventory of India's natural resources leading to her rapid economic development.

The National Atlas Organisation of India is compiling topical atlas maps in which emphasis is given to socio-economic distributional patterns.

INTERNATIONAL MAP OF THE WORLD ON THE MILLIONTH SCALE (IMW)

Promotion of the publication of the International Map of the World on the Millionth Scale

We still recommend the standardization and adoption of the Interim Specifications presented by India at the first United Nations Regional Cartographic Conference for Asia and the Far East, held in Mussoorie, India, in 1955, for international use. The importance of flexibility of specifications being continued to be adopted as an interim measure is once again stressed and our recommendations in this respect are as follows:

(i) Countries should be allowed to produce maps with modifications of requirements; specifications necessitated by certain factors of their local requirements;

(ii) To revise editions quickly, changes in salient features only, such as metalled roads, railways and international boundaries, should be incorporated;

(iii) In the absence of information from neighbouring countries, countries should be allowed to publish maps with blank areas for the neighbouring countries. Alternate production of smaller-scale maps, e.g., on the scales of 1:4,000,000 or 1:2,000,000, is recommended.

Report on progress made

India has been concentrating on the preparation of both the IMW and the 1:1,000,000 ICAO World Aeronautical Charts which fall under India's production responsibility on two different specifications. The interim specifications based in general on the resolutions of 1913 and 1928 of the Central Bureau of the IMW, with certain modifications to embrace our own requirements for standardization as put forward before the Mussoorie Conference, are being followed for the IMW series sheets, while the international specifications framed by the International Civil Aviation Organization (ICAO) and published as "International Standards and Recommended Practices—Aeronautical Charts—Annex 4 to the Convention on International Civil Aviation" are being followed in respect of the ICAO charts.

Out of twenty-one IMW sheets, four are expected to be published by the end of 1961 and the others are at various stages of drafting and printing.

Out of twenty-three sheets of the ICAO WAC series, eleven have been published and the others are at various stages of printing.

The adoption of the recommendations made above will, however, considerably accelerate the progress.

International standardization of sheet lines and projections for the land and air series on a 1:1,000,000-scale

Our IMW sheets are based on the International Polyconic Projection and specified sheet lines while the ICAO charts are on the Lambert Conical Orthomorphic Projection and specified sheet lines. As a temporary measure, we have no objection to other member countries adopting any other standard type of projection and sheet layout to meet their requirements in order to expedite publication.

International standardization of spelling and transliteration of names

An advisory board has recently been set up by the Government of India with a view to standardizing methods of transliteration of regional names to standard scripts on a national basis and also to finalizing spelling of place names on maps of foreign countries appearing in atlases produced in the country. We recommend that such advisory boards should be set up in all member countries and that there should be co-ordination at the international level through the United Nations among all such advisory boards.

Recent development in technical equipment used for aeronautical charts

No attempt has so far been made in India to adopt the recent developments in technical equipment used for aeronautical charts in the United States of America as shown in the paper read at the Second United Nations Regional Cartographic Conference for Asia and the Far East. We are, however, watching with interest the developments made in other member countries with a view to adopting the best possible technique in our country.

ACTIVITIES OF THE HYDROGRAPHIC DEPARTMENT

Surveying ships

During the period, the Surveying Group of the Hydrographic Department consisted of INS Investigator, Sutlej and Jumna. Sutlej was paid off and placed in category "Z" in 1958 for D-2 refit and proper conversion for her employment as a surveying vessel.

A new surveying ship, Darshak, whose keel was laid on 14 October 1957, was under construction at the Hindustan Shipyards, Vishakhapatnam. The ship was launched on 2 November 1959 and is to be provided with a helicopter and two thirty-five-foot survey launches.

Hydrographic School, Cochin

The Hydrographic School, which is responsible for the training of the officers, sailors and civilian personnel of the Hydrographic Department, was established in Bombay in 1959. The school also undertakes the training of hydrographic officers from maritime states and major ports in India. The school has since been shifted to Cochin where it commenced functioning early in October 1961.

Surveying personnel

The position regarding the cadre of surveying officers and sailors has eased a little during the period under report, by additional volunteers and by the appointment of general service officers for limited periods.

The cadre of cartographic personnel has also increased.

Work carried out

After the initial period of training and consolidation, the inaugural chart of Elphinstone Harbour and Approaches (Andaman Island) was published on 15 January 1959. Since then, planned publication of the Indian series of charts and ancillary publications has been in progress. The details of charts and publications issued by the Hydrographic Office during the period under report are given in appendices I and II.

ESTABLISHMENT OF DECCA CHAINS IN INDIA

Two Decca chains, one covering the area of the Gulf of Kutch and the Gulf of Cambay and the other covering the approaches to the River Hooghly, are being established in India. The Bombay chain is expected to be operational by October 1961 and the Calcutta chain by March 1962.

Useful and important information relating to Indian waters continued to be received from various authorities and merchant ships, etc. In accordance with custom, new charts and publications issued by the Hydrographic Office were freely exchanged with the hydrographic offices in other countries.

APPENDIX I

CHARTS

Chart number	Title of chart	Natural scale	Date of publication	Price (rupees)
4001	Elphinstone Harbour and Approaches	1:35,000	15 January 1959	3 00
3001	Approaches to Madras (1:50,000) Madras Harbour (1:12,500)	—	15 August 1959	4 00
3002	Approaches to Vishakhapatnam (1:50,000) Vishakhapatnam Harbour (1:12,500)	—	15 August 1960	5 00
2001	Port of Bombay (northern portion)	1:12,500	15 December 1960	5 00
3003	Pondicherry (1:25,000) Cuddalore (1:25,000)	—	31 December 1960	3 00
2002	Mangalore	1:15,000	14 April 1961	3 00
2003	Beyepore (1:25,000) Badagara (1:25,000)	—	15 July 1961	3 00

APPENDIX II

NAVIGATIONAL PUBLICATIONS: SAILING DIRECTIONS, LIST OF LIGHTS

<i>Title</i>	<i>Date of publication</i>	<i>Remarks</i>
Approaches to Madras and Madras Harbour	6 January 1960	To accompany Chart 3001
Elphinstone Harbour and Approaches	1 July 1960	To accompany Chart 4001
Approaches to Vishakhapatnam and Vishakhapatnam Harbour	16 August 1960	To accompany Chart 3002
Approaches to Kandla and Kandla Harbour	21 November 1960	
Pondicherry and Cuddalore	31 December 1960	To accompany Chart 3003
Mangalore	14 April 1961	To accompany Chart 2002
Indian List of Lights and Fog Signals, 1961, corrected up to 31 December 1960		

GEODETIC WORK IN IRAQ¹

GENERAL INFORMATION

Iraq's area is approximately 444,447 square kilometres. Of this area, nearly two-thirds, i.e., the north-eastern part of the country, includes all the cultivable area. The remainder in the south-west, approximately 150,000 square kilometres, is semi-desert, valuable now for grazing, but inhabited by wandering tribes with no fixed dwellings or houses.

The main central state survey agency in Iraq is the Directorate General of Surveys which is in charge of the general mapping of the country. This agency provides all the civilian services with necessary topographic maps and geodetic data.

TRIANGULATION

Primary triangulation

Primary triangulation was carried out a few decades ago, during the period 1929-1933. It consists of a single chain running, roughly, from north to south, and covers an area of about 12,500 square kilometres. The triangles have been laid out in series and form interlaced central polygons, i.e., quadrilaterals with diagonals.

Three base lines, equally spaced along the chain, have been measured. One station of the central base line was determined by astronomical observations. At the southern base line only the astronomical azimuth was observed.

The adjustment of the chain has been done by the least squares method and computations were performed on Clark's spheroid 1880.

Though the work appears to have been done well, and the triangular error is less than $\approx 3''$, the accuracy obtained for the primary triangulation is not satisfactory. This category of triangulation can only be considered, according to international standards, as a secondary one. This insufficient accuracy is probably a result of the size and shape of the triangles and the length and accuracy of the base lines, as well as unsatisfactory astronomical determinations.

¹ The original text of this paper, submitted by Iraq, appeared as document E/CONF.36/L.70.

Undoubtedly, this triangulation has to be replaced in the near future, when observations will have to be made in new surveys with modern high-precision instruments. Therefore, preparatory steps have already been taken, particularly with respect to using electronic equipment.

Secondary triangulation

This triangulation, based upon the primary one, consists of chains of triangles and sometimes of series of polygons with central points or quadrilaterals with diagonals. It covers an area of approximately 76,500 square kilometres.

Some base lines have been established for checking purposes only. According to the accuracy obtained, the secondary triangulation should be considered as a tertiary one.

The surveys of the secondary triangulation were started in 1936, and have been carried on continuously up to the present.

Tertiary triangulation

This triangulation covers the areas, totalling 230,000 square kilometres, which lay between the chains of the primary and secondary triangulations.

This triangulation had been carried out simultaneously with the secondary one. It may be mentioned that, northward from parallel $\Phi = 35^\circ$, the solution has been computed in terms of the Transverse Mercator Projection, while, for the southern area, geographical co-ordinates have been applied (spherical system based on Clark's spheroid 1880). The work of converting all of the co-ordinates of all the triangulation stations to the Universal Transverse Mercator System is now nearly completed.

PRECISE LEVELLING

The precise levelling lines are 2,700 kilometres long. They run along the three main rivers (Tigris, Euphrates and Diyala) and, though the error is within the range ± 1.0 millimetre per kilometre, it is desirable to repeat the levellings in the near future, as they are fifty years old. It is quite obvious that the old levellings cannot be considered reliable. New observations have already been started.

There is also a network of secondary levelling which was established in 1934 and has been continuously extended. The actual length of these lines amounts to 2,500 kilometres and the accuracy is a satisfactory one.

DETAIL SURVEY

In the past two years a land distribution survey has been taking place which is taking up an enormous portion of Iraqi surveyors' capacities. An area of approximately 561,000 hectares of cultivable land has been divided. These small properties of land were of different sizes, varying from 2.5 hectares up to thirty hectares, according to local conditions, and were assigned to 19,000 farmers. It is anticipated that for the next five years, 2 million more hectares will be distributed to about 40,000 farmers.

AIR SURVEY

Iraq is now engaged in a most extensive photogrammetric project, which is being carried out on the basis of good co-operation between this Department and foreign establishments. The aim of this project is to meet the requirements of the country for development in various fields, e.g., engineering, industry, agriculture, town planning, etc.

Aerial photography and photogrammetric mapping will cover an area of approximately 350,000 square kilometres, as follows:

1. Topographic mapping at 1:25,000 scale, with contours at five-metre vertical intervals, of an area of approximately 80,000 square kilometres;

2. Mapping at 1:10,000 scale of an area of approximately 100,000 square kilometres;

3. Photography at 1:50,000 scale of an area of approximately 170,000 square kilometres.

The period for completion of the project will be forty-two months, beginning in August 1961.

This Department has recently established an air survey unit, excluding photography, which is equipped with the following:

- 4 Wild autographs A8;
- 1 radial triangulator;
- 1 rectifier Zeiss SEG V;
- 1 multiplex;
- 1 electronic printer.

The construction of a very modern building for this unit will be started within a short time.

Several surveyors have been trained abroad at the well-known International Training Centre at Delft. Training of new personnel still goes on, and there is every sign that after a couple of years, the Directorate General of Surveys will be able to comply with requests to execute photogrammetric mapping with its own personnel.

In the future, steps will also be taken to establish a photographic unit able to carry out aerial photography.

CARTOGRAPHY

General information

As yet, Iraq has no standard cartographic series at any scale covering the whole country. Since the majority of demands on the national economy are overwhelmingly agricultural, small-scale mapping has not had a chance to develop. Efforts will have to be made to correct this situation.

Medium-scale topographic maps

A series of about 160 sheets on the scale of 1:50,000 has been compiled and issued during the past ten years. The sheets cover the areas along the three main rivers. The size of each sheet is 15' along the meridian and 15' along the parallel. Approximately 60 per cent of the sheets have contours.

Large-scale topographic maps

Scale 1:20,000

On this scale, maps covering the central and southern parts of the country have been produced. The number of sheets involved amounts to about 700, of which 70 per cent are fitted with contour lines. The size of maps is 6' along the meridian and 6' along the parallel.

Scale 1:10,000

Nearly 1,500 sheets of the areas along the three main rivers have already been compiled and issued at this scale. Sixty per cent of these sheets have contour lines. Each sheet covers an area 3' along the meridian by 3' along the parallel.

Large-scale cadastral maps

The scale of these maps is not uniform; it varies from 1:20,000 to 1:5,000. Some of them are on an even larger scale. At the present time, approximately two-thirds of the country's area, i.e., nearly all cultivable lands, are covered by cadastral maps.

REPORT ON GEODETIC WORKS, CARTOGRAPHY, REPRODUCTION AND CADASTRAL SURVEY CARRIED OUT BY THE SURVEY OF ISRAEL DURING THE YEARS 1958-1961¹

The present report is divided into sections according to the various activities of the Survey Department.

GEODESY

Triangulation

The primary triangulation providing an immediate basis for mapping control points has been completed for the whole country.

The basic frame network of primary triangulation having been laid down, and observation completed, the adjustment was started and is now being carried out by the least squares method according to the method of stages.²

The total number of conditional equations is 256, of which there are 159 angle conditions, eighty-seven side conditions and ten enforcing conditions for azimuth and ten enforcing conditions for azimuth and length. The average length of a side is thirteen kilometres.

¹ The original text of this paper, submitted by Israel, appeared as document E/CONF.36/L.77.

² Described in H. F. Rainsford, *Survey Adjustments and Least Squares* (London, 1957), pages 203 to 205.

Astronomical observations

Only the results of azimuth observations from three triangulation stations along the network were utilized in the adjustment, thus supplying the appropriate conditional equation in azimuth. The observations for latitude and longitude were used only as a check, since the new network is connected with that already existing in the north.

Levelling

Along with the adjustment of primary triangulation, the adjustment of the precise levelling network has been undertaken. A tide gauge was installed at Eilat in order to establish mean sea level.

Levelling operations have been increased recently in order to provide control for various development projects.

After we connect the Mediterranean and Red Seas (Gulf of Eilat) by precise levelling we are anxious to see whether, after all orthometric corrections have been made, the apparent difference of elevation is caused only by the probable error of the observations.

Magnetometry

A provisional magnetic observatory is now under construction. In the absence of such an observatory, accurate information for geodetic work could not be provided. The field survey of the magnetic elements is carried out by the Survey field parties.

PHOTOGRAMMETRY

The main tasks for which photogrammetry is now used are: aerial photography; production of basic maps for universal use, and special maps and plans, produced within the framework of development projects, such as plans for highway and railway construction, agricultural settlements, etc.

Aerial photography

Every year, about 8,000-10,000 square kilometres are photographed with RC5A cameras (Wild) using mostly Aviogon (f-11.5 cm) and Aviotar (f-21 cm) lenses. A DC3 aircraft is used for taking aerial photography.

The scale of the photography varies between 1:10,000 and 1:25,000, although photography at the scales of 1:6,000 for large-scale mapping and of 1:50,000 for smaller scales is also undertaken.

Air photographs are supplied to specialists in different fields, including those in agriculture, geology, highway and railroad engineering, archaeology, hydrology and many others. Enlargements and mosaics are also supplied on request.

Basic maps

The publication scales of these maps are as follows:

- (i) 1:20,000 in highly developed areas, which means the whole northern part of the country;
- (ii) 1:50,000 in desert areas of the southern part, which is called the Negev.

The photogrammetric plotting scales for these maps are 1:10,000 and 1:20,000, respectively. Control is established by third and fourth-order triangulation in the field, and it is intensified by strip aerial triangulations on first-order instruments, such as the Wild A7.

During the period 1958-1961, 2,000 square kilometres were plotted on a 1:10,000 manuscript scale and 7,000 square kilometres on a 1:20,000 manuscript scale.

The photogrammetric plotting instruments used were the Wild A6 and the Wild A8.

During the period, the following maps were completed on three main scales:

1:100,000 scale	26 sheets
1:50,000 scale	7 sheets
1:20,000 scale	10 sheets

Special maps

Several photogrammetric mapping projects have been carried out during the past three years, including the following:

(a) Strip survey of an oil pipeline of about 500 kilometres, after execution of the project;

(b) Very accurately contoured maps, on the scale of 1:2,000 for the regulation of the Yarkon River. This special project included the preparation of 200 profiles measured photogrammetrically;

(c) Geological mapping of an area of 2,000 square kilometres on the scale of 1:20,000;

(d) Large-scale surveys on the scale of 1:500 with a contour interval of 0.5 metre, covering a total area of fifty square kilometres;

(e) Damage and land use conditions are interpreted by comparing aerial photographs taken at successive intervals.

Improvements in equipment and methods

Signalization of points in the field and improvement of the flights have cut down the costs of large-scale surveys.

In aerial triangulation, natural points were replaced by picked points, according to the Delft method. The adjustment of these triangulations is now carried out with the least squares method.

CARTOGRAPHY

Topographic maps

The topographic maps covering the whole country produced by the Department vary in scale from 1:10,000 to 1:50,000. The contour interval for topographic maps on the scale 1:10,000 is generally five metres. Maps on the scale of 1:20,000 use an interval of ten or twenty metres, depending on the terrain, and those on the scale of 1:50,000 usually have an interval of twenty metres. All mapping is done from vertical air photography and field work for control is carried out in all parts of the country.

Cartographic techniques

During this period there has been a considerable improvement in the materials used in cartography. The paper mounted on metal sheets has been replaced by plastic sheets, translucent or transparent, with good dimensional stability. Generally, ink drawing has been replaced by scribing on a coating applied to a sheet of glass or plastic. The direct negatives or positives are prepared at the publication scale. As far as possible, all the basic maps are scribed on glass to ensure maximum accuracy. General purpose maps are scribed on plastic material. Conventional signs, names and numbers are prepared on strip film, and affixed to the plastic sheets or glass plates.

Shaded relief maps

A new general map of Israel on the scale 1:250,000, in two sheets with hypsometric hill shading, was published. The density of tone represents the value of height at each given point.

Economic map

The need for a map which would give information on agricultural development and general planning was the subject of an extensive investigation carried out last year. It resulted in a detailed programme for publishing a series of topographical maps at a reasonable cost. The first sheets are now under preparation.

The Atlas of Israel

The publication of the National Atlas of Israel was initiated in 1956, and it is expected to be completed early in 1963. The Atlas is published in a number of folders, two of which are issued annually. Eight folders, containing seventy-three sheets, have been published so far. The Atlas is expected to have about 100 double sheets containing over 600 maps. The size of the sheets is 50 × 35 cm. The Atlas covers an extensive range of fields.

CADASTRAL SURVEY

Cadastral surveying has been continued in various parts of Israel, including towns and villages. The most extensive work was done in the southern part of the country.

Today, about 75 per cent of the total area of the country is settled or under cadastral survey for settlement.

The method of cadastral survey is numeric, based on control points and chain surveying. An attempt is being made to combine field survey methods with those of photogrammetry. Boundary points are measured in the field, but the addition of the existing topographic features (planimetry only) is accomplished by photogrammetric methods. Thus, essential accuracy is safeguarded and cost kept down.

The omission of development projects in the hitherto undeveloped southern part of the country, such as construction of new settlements, roads, water and oil pipelines, called for the cadastral surveying of large areas.

Since at present the developed area in the southern part of the country is comparatively small, it was decided to carry out the survey by graphic methods using aerial photography. In contrast to the northern part of the country, the area is divided not into blocks but into rectangular sheets on the scale 1:20,000. Each sheet contains a number of blocks whose boundaries are formed by natural features, such as *wadis* or roads.

The time required for preparing each sheet, representing an area of 100 square kilometres by photogrammetric (graphical) methods, varies from fourteen to sixteen man-days. This does not include photography or the field work in connexion with control points.

During the past three years the cadastral mapping of 92 square kilometres has been completed. This includes village and town areas mapped on the scales 1:2,500, 1:1,250 or 1:625. The average work for villages and towns is as follows:

(a) Village survey of one square kilometre, according to the difficulties in chain survey, the number of parcels and their shape, requires from forty-five to 270 man-days (a survey party consisting of a surveyor and two chainmen);

(b) The office work for village areas varies from twenty-five to forty days per square kilometre;

(c) Town survey for cadastral mapping needs approximately 1,200 man-days in the field and 300 man-days of office work.

No final method has been accepted yet for the solution of the problem of resettlement.

ENGINEERING SURVEYS

In connexion with considerable development projects which have taken place, the Department carries out engineering surveys on large projects, in particular the construction of roads, irrigation works, dams and the planning of new settlements.

Deformation observations are carried out on a number of engineering projects which are under constant inspection to determine periodic deformation changes.

REPORT OF CARTOGRAPHIC WORKS IN JAPAN FOR THE PERIOD FROM 1958 TO 1960¹

Prepared by the Geographical Survey Institute, Japan

GEODESY

Base line measurements

Since 1958 the Geographical Survey Institute (GSI) has surveyed base lines for first-order triangulation with a geodimeter (NASM 2) and a spherical reflex system assuming the velocity of light wave in vacuo to be 299,792.5 kilometres per second. During this period four second-order enlarged sides of the base line nets and four first-order triangulation sides were measured. The error seemed to increase with the increasing length of the side;

the minimum mean error of a result for all eight sides was ± 3 mm (for 19 kilometres) and the maximum ± 9 mm (for 39 kilometres).

In 1959 two precise base lines, 1.5 kilometres and 2.0 kilometres in length, perpendicular to each other, were established and measured by Jäderin wires for the purpose of finding out horizontal land deformation in Niigata where ground sinking is remarkable. The measurement will be repeated in 1961.

Acting on the resolution adopted at the Second United Nations Regional Cartographic Conference for Asia and the Far East, held in Tokyo in 1958, a base line 10 kilometres in length was planned in 1960, but it was not realized for financial reasons.

¹ The original text of this paper, submitted by Japan, appeared as document E/CONF 36/L 76.

Triangulation

The revision survey has been continued during the current period. Areas of about 67,000 square kilometres, including forty first-order triangulation points in Kyushu (western island) and in the middle part of Honshu (main island), were surveyed. Based on the comparison between the results of the revision survey and the previous survey, the displacements of triangulation points, which are due to the secular change of the crustal surface and the sudden land deformations accompanying the earthquakes occurring in Japan, are being deduced.

Lower-order triangulations have been carried out in connexion with new mapping projects and the cadastral survey.

The use of automatic computers has been increased for adjustment, especially for that of lower-order triangulations.

Levelling

The total length of the revised first-order levelling routes during the period covered was about 5,267 kilometres.

The levelling survey has been repeated frequently, especially in Tokyo, Osaka, Nagoya, Niigata and their vicinities, in order to obtain the information of ground sinking due to the increase in the consumption of underground water for industrial use in each area.

The Hydrographic Office (HO) has conducted levelling surveys for the purpose of keeping the chart datum and investigating land subsidence in nine areas. Since 1960, the members of the HO have carried out precise soundings off Yokohama, Kobe and Niigata in order to investigate the subsidence of sea bottom.

Traversing by tellurometer

Trial second-order traversing surveys were carried out using the tellurometer in the areas in the Gumma and Shizuoka Prefectures where positions of points were already known by the conventional method of fourth-order triangulation. The results obtained are as follows:

District	Number of measurements	Range of length	Average mean error (internal)	Average difference: tellurometer-triangulation
Gumma	12 sides	0.7-4.2 km	1:45,000	1:28,000
Shizuoka	16 sides	1.1-2.6 km	1:25,000	1:19,000

Astronomy

1. Laplace stations

During the period covered, eleven Laplace stations have been observed and the observations of longitude and latitude have been made at twenty-three stations. All Laplace stations are first-order triangulation points and the remaining twenty-three stations are second-order points.

On the Laplace stations a transit instrument of 70 mm in aperture with an electric transit detector (ETD) was used. The longitude was determined by observing the meridian transit of stars and the latitude by observing the prime-vertical transit instead of by the Horrebow-Talcott method. In azimuth observation, the meridian mark was observed by means of a moving knife-edge attached to the ETD.

A comparison of the results obtained in the field work between the Horrebow-Talcott method and the prime-vertical method is shown as follows:

	Horrebow-Talcott method	Prime-vertical method
Standard deviation for a single observation	$\pm 0.6''$ (one pair)	$\pm 0.5''$ (one star)
Probable error for the most pronounced value	$\pm 0.07''$ (about 25-39 pairs)	$\pm 0.04''$ (about 60 stars)

Observations other than those at the Laplace stations are carried out by using a new type of astrolabe 60 mm in aperture, 80 cm in focal length, with an ETD which has recently been developed by the members of the GSI.

2. Base point at the Kanozan Geodetic Observatory

As a base point for the field work using astronomical observations, two observation rooms were built in the compound of the Kanozan Geodetic Observatory. A continuous observations of longitude has been executed

since the beginning of 1959 in one of the rooms. The adopted astronomical and geodetic positions are as follows:

Geodetic longitude	9 ^h	19 ^m	50.154 ^s
Astronomical longitude	9 ^h	19 ^m	50.203 ^s
Geodetic latitude	35°	15'	6.06"
Astronomical latitude	35°	15'	25.27"
Elevation above mean sea level (metres)	353.3		

The other room is being used to check the observation before and after field work and to test observations with a new instrument.

3. Occultation observations

For the purpose of linking geodetic co-ordinates, occultation observations along the equal-limb lines between Japan and the islands in the Pacific Ocean have been executed by the interested agencies of Japan in co-operation with the United States Army Map Service, Far East (USAMSFE). The three agencies of Japan, the Tokyo Astronomical Observatory, the HO and the GSI, have taken charge of the observations in the Japanese Islands, and the USAMSFE of those in the islands in the Pacific Ocean.

Following are the number of successful connexions obtained between Japan and the Pacific islands:

	1956	1957	1958	1959	1960	1961
Japan—Marcus Island	3	1	1	1	1	—
Japan—Wake Island	1	—	2	2	—	2
Japan—Taiwan	3	—	—	—	—	—
Japan—Midway	—	1	—	—	—	—
Japan—Hawaii	—	—	—	—	—	1

4. Observation of annular eclipse

On 19 April 1958, the HO observed the contact times of an annular eclipse together with geomagnetism at

Ao-ga Shima, Takara Shima and Amami O-Shima off the southern coasts of Japan. At the total eclipse on 12 October 1958, HO dispatched a field party to Suworror Island near New Zealand to make the observation of the total light of the corona as well as the contact times.

Gravity

1. Pendulum stations

Precise gravity values were determined at the following stations by the GSI pendulum apparatus at different periods; some stations were re-occupied several times.

Station	g (gal)	Latitude and longitude	Height (metres)	Date
Kakioka (new)	979 9804 ± 0.0001	36°13 8'N 140 11.5 E	32.17	Aug.-Sept. 1960
Kumamoto	979 5656 ± 0.0001	32 48.8 N 130 43.8 E	22.84	Feb.-March 1961
Kanozan	979.7042 ± 0.0003	35 12.5 N 139 57.5 E	350.52	March 1958
Fukuoka	979 6426 ± 0.0001	33 35.7 N 130 22.7 E	31.30	Feb.-March 1961
Relative to Tokyo (GSI)	979.7770 ± 0.0001	35 38.6 N 135 41.3 E	28.04	

Kakioka and the GSI are the terminal stations of the calibration line for the gravimeter, and in 1957 a new permanent gravity room was built at Kakioka. Several measurements have been executed between Kakioka and the GSI to increase the accuracy of the calibration line.

Kumamoto is the southernmost pendulum station in Japan and the previous measurement relative to Chiba (old GSI) was carried out in 1953. Kanozan station is in the Geodetic Observatory of the GSI where the earth tide records were obtained by means of an Askania GS-11 gravimeter during the IGY.

2. International connexions

(a) Tie between Japan and Antarctica

During the period covered, the difference between the gravity values at the Trigonometrical Survey Office, Cape Town and the Showa Base (69° 00.4'S, 39° 35.4'E) was determined by a Worden gravimeter as one of the works of the fifth Japanese Antarctic Research Expedition, as follows:

$$\begin{aligned} g_{\text{Singapore}} &= 978.0805 \text{ gals,} \\ g_{\text{Cape Town}} &= 979.6470 \text{ gals, and} \\ g_{\text{Showa Base}} &= 982.540 \text{ gals} \end{aligned}$$

relative to the international first-order station of Japan, Kyoto $g_{\text{Kyoto}} = 979.7215$ gals).

The pendulum observation at the Showa Base will be carried out in 1962.

(b) Tie from Japan to Beirut and Rome

The international connexions between Rome, Beirut and Hakone, Japan, were carried out in March 1959, with the co-operation of Italian and Japanese geodesists, by using four Worden gravimeters. The preliminary result of the gravity difference between Beirut and Hakone is:

$$g_{\text{Beirut}} - g_{\text{Hakone}} = 30.79 \pm 0.073 \text{ (m.c.) mgals.}$$

Hakone station was established as an air terminal gravity station for the international gravimetric tie, because it is located near the Tokyo international airport and its gravity value is nearly equal to that of Kyoto. The gravity value of Hakone was determined by use of a North American gravimeter and a Worden gravimeter

based on the values of the GSI, Chiba, and the Earthquake Research Institute, Tokoyo University, as follows:

$$g_{\text{Hakone}} = 979.7230 \text{ gals (35° 14.4'N, 139° 03.8'E, height 426.9 m 1958).}$$

c. Tie between Japan and Australia

A gravity tie measurement between the Geophysical Laboratory of Mineral Resources, Melbourne, the international first-order station of Australia, and the GSI was made with the aid of a new-type GSI pendulum apparatus during the period from February to May 1959. The gravity difference between these two stations is

$$g_{\text{Melbourne}} - g_{\text{Tokyo GSI}} = -202.1 \pm 0.2 \text{ (m.c.) mgals,}$$

where

$$g_{\text{Tokyo GSI}} - g_{\text{Kyoto}} = +55.1 \text{ mgals.}$$

3. Gravimeter survey

During the period covered by this report, a serial gravity survey of every bench-mark (average distance, 2 kilometres) was carried out in the western part of Japan in accordance with the project of gravity survey for the whole country. The survey, started in 1952 by the GSI, using a North American gravimeter, lasted up to 1960 and covered the whole of Japan. From 1961, a survey will be executed for the purpose of obtaining geophysical data.

The gravimeter networks were adjusted referring to the gravity values at the pendulum stations.

4. Average elevation map

As a preparatory work for compiling mean elevation charts on the scale 1:200,000, a reading of the mean elevation from topographic maps on the scale 1:50,000 and a bathymetric chart of the vicinity of the Japanese coasts has been completed for the whole country with the exception of Hokkaido (northern island).

5. Studies on related problems

(a) In August 1961, Professor C. Tsuboi, of Tokyo University, and his associates conducted a trial gravimetric observation on the survey ship Takuyo, in co-operation with the HO, in the sea areas between Honshu and Kyushu

with a submarine gravimeter of a short-period pendulum and a vertical gyroscope; the result was successful. This instrument will be employed for the International Indian Ocean Expedition from 1962 to 1963 and for the observation of the Upper Mantle Project after 1962.

(b) Another type of surface ship gravimeter is being built by the GSI. It consists of a mass (about 10 g) suspended by three beryllium copper strips about 5 cm long which are made perpendicular to each other so as not to make the dynamic movement of the mass relative to its supporter even when the ship rolls and pitches. For the purpose of reducing the small vibration of the mass, a magnetic damper is placed under it.

GEOMAGNETISM

Field magnetic surveys

Magnetic surveys by the GSI are classified into two categories, first and second order, according to the observational conditions and the re-occupation periods.

	1958	1959	1960
Number of the first order	16 (northern part of Japan)	18 (western part)	17 (northern part)
Number of the second order	95 (Hokkaido)	95 (Hokkaido)	55 (Tohoku)

Aeromagnetic survey

In accordance with the resolution of the Moscow Meeting of CSACI, 1958, an aeromagnetic survey of Japan has been planned by the National Committee for Geodesy and Geophysics of the Science Council of Japan. Surveys of land and sea areas will be carried out from 1961 to 1964 by the GSI and the HO.

As the first step, the HO carried out aerial magnetic surveys off the southern coasts of Honshu and Izu Islands four times with air-borne magnetometers (flux gate type) newly designed by Tohoku University. They are going to carry out the aerial magnetic survey for about 9,000 nautical miles in the sea areas around Japan.

The GSI has been developing an air-borne proton precession magnetometer for that purpose.

Magnetic chart

During the period, the HO published a new series of magnetic charts of the adjacent seas of Japan as of 1955 for the declination, horizontal intensity and dip with their annual changes, respectively, at a scale of 1:10,000,000. These charts were compiled from the sixth magnetic survey of Japan during 1954-1955. From 1959 to 1960, the seventh survey of Japan was carried out at sixty-six stations to prepare the series of magnetic charts as of 1960, among which the curves of the declination are to be published in November 1961. Local magnetic surveys were made at several islands and peninsulas in 1958.

Marine magnetism

In January 1960, the HO surveyed marine magnetism on the Takuyo in Sagami Nada with the Tohoku University-type ship-borne magnetometer, and on seamounts and a volcano near Kyushu in August 1961.

Magnetic stations are marked by a granite monument and the re-occupation survey is executed exactly on the same point.

The first-order magnetic survey aims to clarify the general features of the geomagnetic field and its secular variation over Japan. The first-order stations now number ninety-one (one station for approximately every 3,000 square kilometres). From them, twenty are selected as the reference stations which are re-occupied every other year in order to obtain the geographical distribution of the secular variation. Other stations are re-occupied every five years.

The purpose of the second-order survey is to obtain data for making reliable geomagnetic charts and to find the regional or local anomaly fields and their changes. About 800 second-order stations have already been established and are planned to be re-occupied every ten years. Since 1958, Hokkaido and the Tohoku district (northern part of Honshu) have been resurveyed.

Standard magnetometer

The GSI constructed a new standard magnetometer for the measurement of the horizontal intensity with an accuracy of 1×10^{-5} . The development of the proton precession magnetometer by the GSI made it possible to measure the absolute value of the geomagnetic field. The comparison measurement between the GSI standard magnetometers and the proton precession magnetometer was carried out at the Kanozan Geodetic Observatory in 1958. The results are as follows:

$$\begin{aligned} \text{Standard No. 1 -p.p.m.} &= -1.3^r \\ \text{Standard No. 2 -p.p.m.} &= +0.6 \\ \text{mean} &= -0.4 \end{aligned}$$

At the Shimosato Hydrographic Observatory earth magnetic variations were observed with ordinary and induction magnetographs as part of the IGY and the IGC observations.

A nuclear precession magnetometer has been constructed by the GSI for the precise measurement of the total magnetic field. They have also developed a nuclear induction magnetometer with an automatic recording system for measuring the horizontal and vertical intensities by using a Fanselau-Braunbeck coil which approximately cancels the vertical or horizontal component of the magnetic field in the vicinity of the magnetometer head. This apparatus has been in operation at the Kanozan Geodetic Observatory.

OCEANOGRAPHY

Tides

Nineteen tide stations are being maintained along the coast of Japan by the HO in order to preserve the accuracy of tide prediction and chart datum and investigate extraordinary tidal phenomena and ground subsidence. Nine

tide stations are being kept by the GSI in order to obtain the mean sea level for the adjustment of the first-order levelling net.

Oceanic currents and others

The HO publishes quarterly charts of the oceanographic status of the adjacent seas of Japan which are compiled from the data obtained through the regular observations, including BT and GEK measurements at about 1,000 spots.

HYDROGRAPHY

Hydrographic surveys

1. Ordinary surveys

During the period covered, in order to keep the nautical charts up to date, the HO has continued its ordinary surveys around Japan as follows:

Harbour surveys (1:3,000-1:10,000)	19
Coastal surveys (1:15,000-1:50,000)	18
Oceanic surveys (1:100,000-1:500,000)	13

For surveys off Hokkaido, the Decca Navigator System is employed.

2. Special surveys

Submarine topography and geology, including gravity, were investigated in connexion with oil exploration off the north-western coasts of Honshu in 1958 and 1959. Submarine topography and geology were investigated as part of the reclamation of Shimabara Kaiwan (Bay of Shimabara) in Kyushu in 1958 and 1959.

In order to provide basic data for the construction of railway submarine tunnels and bridges between Honshu and Hokkaido and between Honshu and Shikoku (south-western island), boring surveys were carried out in 1958 and 1959. Geological surveys were made on several routes connecting Honshu and Shikoku from 1959 to 1961 for the highway bridge work.

In connexion with the project of laying submarine cable between Japan and Guam, surveys of submarine topography and geology, as well as observations of the bottom temperature, were carried out off the southern coasts of Honshu and between Honshu and Guam in 1960 and 1961, and sixteen seamounts with elevations larger than 3,000 metres were discovered.

In order to secure fairways, emergency surveys were made in the Nagoya district after the Isewan typhoon (Vera typhoon) in September 1959, and in the north-eastern coasts of Honshu after the tsunami caused by the Chilean earthquake in May 1960. It was learned that submarine topography exerts a great influence upon disasters caused by tsunami or high tides in coastal areas.

Several seamounts and guyots have been discovered in the Japan Trench and off the southern coasts of Japan.

For the International Indian Ocean Expedition during the period 1962 to 1963, the HO is going to design a precise deep-sea echo sounder, the accuracy of which is expected to be better than 1:5,000.

Drafts and reproductions

1. Number of publications

New charts	Charts	1958-1960
Nautical		21
Special		13
Aeronautical		0

New editions	Charts	1958-1960
Nautical		71
Special		27
Aeronautical		1
Reprints		96
2. Number of charts available on 30 September 1961		
Nautical		1,476
Special ^a		209
Aeronautical		13
		TOTAL 1,698

^a Bathymetric, geological, fishery, magnetic, etc.

3. Research and development

Since 1958, the stick method has been used extensively for the drafting of charts. At present, the scribing system is employed for about a quarter of the drafting. Since 1959, photographic film has been used as the original copy instead of zinc plate.

In 1960, the HO developed the "Neo-Vandyke Process", utilizing polyvinylalcohol for sensitizer, by which a line can be engraved clearly without the need for a drafting specialist.

PHOTOGRAMMETRY

In Japan, photogrammetry has been widely applied for topographic surveying. For example, it has been used for producing not only medium-scale maps but also maps on such large scales as 1:500 and 1:1,000, used mainly for the integrated land development programme. In terms of areas and their use, aerial photographs taken during the period are as follows:

Table 1
(Square kilometres)

City planning	29,300
Harbour improvement	4,940
River improvement	9,480
Forestry reserves	50,600
Land improvement	9,240
Highway planning	8,720
Railroad planning	4,370
Transmission line planning	9,540
Soil conservation	2,080
Cadastral survey	190
Others	18,560
TOTAL 147,020	

The aerial photographs were taken on various scales according to their purpose; for example, aerial photographs for topographical mapping were taken, in general, on the scales of from 1:25,000 to 1:40,000, while those used for city planning, land improvement, cadastral survey, etc. were usually taken on the scales of from 1:6,000 to 1:20,000.

The aerial cameras now chiefly in use are listed in table 2.

Table 2

Wild RC5a	5
Wild RC8	15
Zeiss RMK15/23	8
Zeiss RMK21/18	4
Zeiss RMK11, 5/18	1

The photogrammetric plotting instruments now in operation are listed in table 3.

Table 3

Stereoplanigraph C5	1
Stereoplanigraph C8	4
Wild autograph A7	6
Wild stereoplotter A8	18
Multiplex	29
Kelsh plotter	26
Nistri photomapper	5
Triplex (made in Japan)	1
Belfort plotter	3
Stereotope	20
Kuramochigraph (made in Japan)	1
Radial secator	3
Automatic rectifier	6

Of these instruments, one stereoplanigraph C8, two stereoplotter A8, sixteen multiplexes, fifteen stereotopes, two radial secators and one rectifier (SEG V) are in operation in the GSI; the stereoplanigraph C8 is applied to aerial triangulation and to mapping on the scales of 1:2,500, 1:5,000 and 1:10,000, together with the stereoplotter A8. Detail mapping on scales of 1:25,000 and 1:50,000 is carried out by multiplexes or stereotopes. Other instruments are used by other agencies and companies.

The requirement for aerial triangulation for small-scale mapping is limited in our country, because the whole land is covered with the third-order triangulation network (one point per eight square kilometres) and the fourth-order triangulation for cultivated land has been carried out. Aerial triangulation has generally been applied to the establishment of passpoints for mapping on larger scales. Recently, the analytical triangulation method has come into practical use and its applied field has been extended to large-scale mapping and even to cadastral surveying.

The whole area of our country is covered with 1,263 sheets of 1:50,000-scale topographical maps, while the coverage of 1:25,000-scale topographical maps is about one-third of the total area. Under these circumstances, our mapping programme is progressing as follows.

(a) *Revision of 1:50,000-scale topographical maps*

Since 1952, when the provisional revision of 1:50,000 topographical maps was completed, a new revision programme has been carried out at an annual rate of about sixty sheets.

(b) *Revision and extension of 1:25,000-scale topographical maps*

The revision and new survey of 1:25,000-scale topographical maps have been made by utilizing multiplexes and stereotopes. In the case of multiplex mapping, the passpoints are determined by means of bridging, while for stereotope mapping, the passpoints are supplied by the stereoplanigraph C8. Since 1958, fifty-nine sheets of the 1:25,000-scale topographical map have been revised and 206 new sheets have been completed.

(c) *Revision and extension of 1:10,000-scale topographical maps*

The surveying of 1:10,000-scale topographical maps has been done with the stereoplotter A8. Since 1958, thirty-four sheets of 1:10,000-scale topographical maps have been revised and twenty-seven new sheets have been completed.

(d) *Mapping for public survey*

Topographical maps produced for public survey in Japan during 1958-1959 are shown in table 4. These are prepared by several agencies and companies from aerial photography.

Table 4
(Square kilometres)

City planning	7,110
Harbour planning	110
River improvement	890
Forestry planning	122,960
Land improvement	1,490
Highway planning	1,880
Railroad planning	880
Transmission line planning	790
Combined development	840
Dam planning	2,960
Reclamation planning	100
Mine exploitation	430
Coastal conservation planning	140
Others	400
TOTAL	140,980

Note. Including plane table method.

(e) *Large-scale mapping project*

The maps listed in table 4 differ from one another in scales, symbols, accuracies, etc. In order to standardize specimens of these maps, the GSI is planning a large-scale mapping project. This new programme consists of three subjects: aerial photography, establishment of more ground controls, and mapping.

Aerial photography is planned to cover the whole land in five years on a scale of 1:10,000 over flat terrain of about 95,000 square kilometres and on a scale of 1:20,000 over the remaining mountainous areas. The flight direction is planned to be mainly east-west.

The ground control surveys are planned with close connexion to the cadastral survey and the existing controls to complete the fourth-order triangulation networks and to increase the second-order levelling routes. As the first step, however, the control points will be established only in narrow selected zones, ten minutes in longitude from each other, to allow aerotriangulation of from ten to fifteen models to be carried out.

Mapping is planned on a scale of 1:2,500 for flat terrain and on a scale of 1:5,000 for mountainous areas. Contour intervals are two metres for the former and five metres for the latter, but these standard contour intervals are reduced, where necessary, to 0.5 metre.

The new project started in 1960. Some 1,880 square kilometres were photographed, 195 control points were established and 200 square kilometres of maps on a scale of 1:2,500 were completed. These works were carried out, as the testing case for the succeeding routine works, by several companies under the supervision of the GSI.

In 1961, aerial photography on a scale of 1:10,000, covering the most important areas—about 31,600 square kilometres, or nearly one-third of the flat terrain—is in progress; about 900 existing control points have been signalized, and about 1,600 new ground control points have been established in selected zones of the photographed areas. These works have been done by companies contracting with the GSI.

COMPILATION OF MAPS

Compiled maps published by the GSI may be classified into two categories, namely, small-scale general maps and topical maps.

Small-scale general maps

The 1:200,000-scale Regional Map and the 1:500,000-scale District Map are the important small-scale general maps.

1:200,000-scale regional map

Each sheet of this series uses the polyhedral projection and includes the region of format $1^{\circ} \times 40'$. There is an old edition in three colours and a new one in five to six colours.

Since all pre-war original copper plates were burnt during the war, as an emergency measure 112 sheets were reprinted from copies of the map in three colours, showing for the country as a whole, contour intervals of 100 metres in brown, hydrography in blue and other features in black.

In order to meet up-to-date requirements for maps, new symbols were established in 1954. At that time, it was planned, using the new symbols, to compile maps to cover the whole country in ten years. The region included and the projection used are the same as those in the old edition. The map is in the following six colours: contours with an interval of 100 metres in green, shading in green and blue, roads in brown, urban areas in red, hydrography in blue and other features in black. Seventy-seven sheets have already been compiled.

1:500,000-scale district map

This series consists of eight sheets. Each sheet, 841 mm \times 1,189 mm, is printed in five to seven colours and the conventional polyconic projection is used. Relief is represented both by hachures and contours with intervals of 200 metres. The compilation of this series started in 1955 and was completed in 1958. It is planned, however, to revise them in the near future.

Besides these two maps, general maps at small scales, including the Map of Japan at 1:2,000,000 and Japan and her Surroundings at 1:2,500,000, are also published.

Topical maps

The GSI has compiled the following topical maps since 1958.

1. *Landform classification map on the scale of 1:50,000*

These maps are based on photo-interpretation and supplementary investigation in the field. Several sheets have already been issued.

2. *Land use map*

By the end of the 1961 fiscal year, three hundred sheets of this series on a scale of 1:50,000 will be ready covering about 30 per cent of the whole country. Furthermore, trial editions on the scales of 1:25,000 and 1:200,000 will be issued.

3. *Maps on disaster*

(a) Maps of the tsunami

The maps measuring damage, i.e., the map of a longitudinal section of the tsunami's height and the map showing the relationship between landform and the tsunami's damage, were compiled with the aid of the analysis of damage investigation of the Chilean earthquake tsunami which occurred in 1960.

(b) Maps of damage by flood

The map showing the relationship between landform and flood was compiled for the areas which have had a number of damaging floods. Since the phenomena of flood and high tide resulting from the Isewan typhoon (Vera typhoon) in 1959 were as predicted by the investigations along these lines and the maps of the tsunami, the final results could be evaluated more significantly. By 1961, the landform classification map for flood, the flood warning map and the map for ground-surface height on a scale of 1:25,000 were completed for the Tokyo District.

(c) Maps on ground subsidence

Recently, the subsidence of ground surface in industrial regions, such as Tokyo, Osaka, Nagoya, etc., has become a significant problem with regard to protection from damage. The investigation is being continued in Osaka and Niigata. Reports on Niigata have been compiled with reference maps.

4. *Lake charts*

Lake charts, compiled mainly from field surveys, using echo sounders, differ from the maps mentioned in 3a, b and c above. The charts for Lake Biwa and Kasumigaura on a scale of 1:10,000 will be completed by the end of March 1962. By applying the same techniques, the marine bottom topographical maps of the Bay of Tokyo have been completed as the basic map for the redevelopment of the metropolitan area, in co-operation with the Hydrographic Office.

5. *1:800,000-scale geographical map series*

The map of population density by landform has already been completed and the land classification map is expected to be completed next year.

The maps relating to the administrative assignment of land are issued by the government agencies concerned. The important ones are: the Geological Map (Geological Survey); the Power Plant Map (Public Utilities Bureau); the Forest Map (Forestry Agency), and the Soil Map (Agricultural Technical Institute).

Map drafting and scribing

The following are the number of topographic map sheets completed by drafting and scribing in the GSI from April 1958 to March 1961:

1:10,000 Topographic Map	48
1:25,000 Topographic Map	489
1:50,000 Topographic Map	256

After the Tokyo Conference, the GSI launched the following important mapping procedures:

1. *Increases in scribing in place of drafting*

The colour separation drafting method with blue-printed A. K. Kent aluminium foil drafting paper is being gradually changed over to the scribing method with opaque coated and printed Mylar sheets. The introduction of scribing raised the efficiency of the production process 15 per cent in comparison with drafting, and improved line work.

2. *Introduction of Mylar tracer as a drafting base*

Mylar tracer is coming to be used as a drafting base for large-scale maps in place of A. K. Kent, for example, for the map of the central highway planning (1:5,000). As a result, mapping is more efficient, expenses are lower and blue-print copying easier.

3. *Amendment of specifications and symbols*

The specifications and symbols of the topographic maps of the GSI were newly established in 1955 and partly revised in 1960.

The important characteristics of the new rules are as follows. The map style was amended from that for military use which had been taken until that time; three colours were used in lieu of monocolour; the UTM

projection was adopted instead of the polyhedric projection, and road symbols were classified by actual width instead of by administrative management.

A digital planimeter has been developed by a company. It measures an area drawn on a piece of paper automatically by counting the scanning time of a light spot. It is expected that this instrument will be very effective and time saving.

REPORT ON THE CARTOGRAPHIC ACTIVITIES OF LAOS¹

A report on present cartographic activity in Laos will quite naturally turn out to be a report on the Laotian National Geographical Service, since it is the only organization in the country that is engaged in this kind of activity. The purpose of this paper is to explain the acuteness and diversity of the problems confronting Laos which, of all the countries in the region covered by this Conference, has the longest way to go along the road to progress.

The Laotian National Geographical Service was created in 1955 after the breakup of the Geographical Service of Indochina and is situated at Vientiane. Its task is not only to compile maps but also to carry out a cadastral survey of the country.

It was from the outset confronted with two difficulties. In the first place, there were no premises in which to install the equipment and the copious cartographic records which had come from Dalat, and, in the second place, Laos did not have a single surveyor, draughtsman or printer. The efforts of the past six years have been devoted primarily to providing the National Geographical Service with basic facilities and to training specialists.

The first task was to construct a building and equip a printing shop, and that has now been done.

Priority was thus given to printing equipment because, owing to the impossibility of completing the map coverage of the country within a reasonable time, the existing maps had to be reprinted as the stocks became exhausted.

At the same time, the training of specialists was initiated. The great effort put into this training has had encouraging results. A group of foremen and leaders of ground survey teams has emerged, and at the present time we should be able on a modest scale to resume the cartographic work that was interrupted.

At the time when the National Geographical Service was established—that is to say, in 1955, when Laos began to concern itself with cartography—out of a total area of 240,000 square kilometres, 35,000 square kilometres, or 15 per cent, had not yet been mapped, 125,000 square kilometres, or 55 per cent, had been covered only by photomosaics, and only 80,000 square kilometres, or 30 per cent, had been covered by regular maps. The scale of the regular maps—1:100,000—is suitable for a base map but is very inadequate for any purpose where precision is a factor. Moreover, these maps are based on a non-conformal projection—the Bonne equal area projection. Also, because of their average age (forty years) and the long time which has passed since the latest revisions (sixteen years), these maps do not meet one of the essential requirements of a map, namely, modernity.

The staff increased from zero in 1955 to twenty-seven in 1957 and sixty in 1959, and reached 110 towards the middle of 1960. This number is admittedly inadequate in the light of the work to be done: 160,000 square kilometres to be mapped and 240,000 square kilometres for which a cadastral survey must be carried out.

GEODETIC NETWORK

(a) The first-order geodetic chains have been almost completed; there are only two or three points to the north of Luang-Prabang still to be linked up. These chains, which were integral parts of the first-order network of the former French Indochina, do not constitute an autonomous whole but rely on bases and astronomical stations situated outside the country. Hence, although a perfect juncture with the networks of Cambodia and Viet-Nam is assured, they are nowhere connected with the basic Thai network despite 1,500 kilometres of common boundary.

This network is seriously deficient in uniformity. Although the observations are generally correct, the computations have been made step by step according to different traverses, with the result that there are sometimes two positions fifty metres or more apart for the same point. The use of these points for further computations is thus made impossible.

We consider it highly desirable that uniformity in the first-order network of this part of Asia should be achieved within the near future. To that end the first step, in so far as we are concerned, would be to connect the Thai and Laotian first-order triangulations and then to select a single basic astronomical point and effect a comprehensive adjustment of the first-order triangulations of Cambodia, Thailand, Viet-Nam and Laos. This programme could be carried out with the recommendation of and under the auspices of ECAFE.

With regard to the detail network, there were in 1955 more than 1,300 points in Laos, distributed over 80,000 square kilometres. These points, which had been fixed by surveyors for immediate use, were impermanent objects, such as trees, house gables and rudimentary beacons, and at least two-thirds of them have disappeared. Since 1955, our surveyors have plotted seventy-four additional points, all near large towns. Although there is still much work to be done, nothing can really be accomplished until the complementary network has been made uniform.

(b) Six years ago there was not a single metre of precise levelling in Laos. This year we decided to begin first-order levelling, taking the zero meridian of Ko-Lak in Thailand as a reference and using the Thai network, which is already

¹ The original text of this paper, submitted, in French, by Laos, appeared as document E/CONF.36/L.79.

well advanced, as a control whenever possible. Fifty kilometres of the 1,600 kilometres which it is proposed to cover have already been levelled.

If circumstances permit, the first-order network will be completed within five years. Our objective is to ensure that no point in the territory is farther than thirty kilometres from a first-, second- or third-order bench-mark. Here too, there is much to be done.

AERIAL AND TOPOGRAPHIC SURVEYS

(a) The National Geographical Service has very little air survey equipment. Two air surveys have been made, both on a scale of approximately 1:40,000. One was made between 1952 and 1955, and the other in the period 1958-1959. As the two surveys were complementary, all of Laos has been photographed.

On the other hand, there is no plotting equipment worthy of the name. There are three *camerae lucidae*, one slotted templet triangulation apparatus, a rectifier and a stereotope. These have made it possible to compile photomosaics for some 6,000 square kilometres since 1959, but maps of this kind are nothing more than makeshift.

The meagreness of our resources in this field is regrettable, because air surveys have taken the place of direct surveys everywhere, and the use of air survey methods is particularly advisable in a country such as Laos where many areas are difficult to reach.

(b) Since it lacks the proper air survey equipment, the National Geographical Service has undertaken some topographic surveys in connexion with route maps for roads and plans of the main towns and surrounding areas on the scale 1:10,000.

(c) In so far as cadastral surveying is concerned, the only property maps now possessed by Laos are those that were compiled at the beginning of the century for the main towns. Because of the inappropriate scale of these maps and the failure to keep the original property lists in order, the entire task will have to be completely redone.

In 1959 the maintenance of the property register was entrusted by a royal ordinance to the National Geographi-

cal Service. Since then, the relevant regulations have been drawn up, and we are hoping to compile maps on the scales 1:1,000 or 1:10,000 according to the importance of the areas to be covered by the property register. Here, too, air survey methods must be used.

PUBLICATION OF MAPS

Before referring to cartographic publications concerning Laos, we should like to point out that under a recent law the use of the Universal Transverse Mercator projection for all surveys of any scope undertaken in our country and the use of the metric system have been made compulsory.

A National Commission on Geographical Names has been appointed for the purpose of standardizing the writing of geographical names.

(a) Aside from special large-scale surveys, Laos is almost entirely covered by regular maps and photomosaics on the scale 1:100,000, as well as by maps on the scales 1:250,000 and 1:400,000 produced by compilation.

(b) Our draughtsmen, most of whom have had only two years of experience, have not yet been able to make a very substantial contribution to the map structure of Laos.

(c) Our reproduction shops, which have been supplied with the proper equipment, have already accomplished valuable work, both in the issue or reissue of maps and in the printing that is done for the government services. The problems of the Laotian Geographical Service are least severe in the matter of printing facilities. That does not, of course, mean that the Service has no printing problems, but the capacity of our printing shop, which is 400,000 impressions a month for large-size sheets, will be adequate for some years to come.

We must also mention the cartographic assistance which organizations such as the Committee for Co-ordination of Investigations of the Lower Mekong Basin have given to Laos in meeting their own requirements. As however, such maps are generally intended for a special purpose, they do not compete with the mapping activities of the Geographical Service.

REPORT ON THE CARTOGRAPHIC ACTIVITIES OF MOROCCO¹

Most of the cartographic work in Morocco is carried out by the Topographical Service. Both government departments and private concerns have recourse to the Service to obtain the maps they need for their various activities.

The history of cartography in Morocco is a long one. Work was begun at the beginning of the present century, and it was the Geographical Service which first planned and carried out the basic projects. The Topographical Service co-operated in this work for a short period, and later, in view of the country's economic requirements and the introduction of land registers, the Topographical Service was given broader powers and consequently took over the Geographical Service.

All of Moroccan territory has now been mapped. The maps, which vary in scale from 1:500,000 to 1:50,000,

do not, of course, all meet the same standards of precision, but the work has been done in such a way as to meet the most immediate needs. While so-called reconnaissance maps on a scale of 1:100,000 or 1:200,000, which are useful for general purposes, have been drawn up for some regions having limited economic possibilities, maps with a high degree of precision have been compiled on the scale 1:50,000 for intensely cultivated areas which it is planned to develop. These maps are being prepared according to a programme established several years ago. The topographical survey, consisting of first- and second-order triangulation which forms a unit with neighbouring territories, is virtually completed. The final step will be taken in 1962, when the primary triangulation along the Tetuan-Oujda parallel, which is now in preparation, is incorporated into the general system.

In addition to geographical maps, the Government has also ordered the preparation of a geophysical map. At the present time, all gravimetric operations based on the

¹ The original text of this paper, submitted, in French, by Morocco, appeared as document E/CONF 36/L.83

horizontal control network of Morocco have either already been completed or will be completed during 1962.

The Topographical Service is also responsible for completing the links that are needed in the supplementary third and fourth-order triangulations. Almost 250,000 points have thus been calculated in the same base network.

On the technical level, the Topographical Service has made great efforts to modernize its equipment and techniques. For example, it has just acquired equipment for photogrammetric plotting.

On the international level, Morocco has joined several organizations, in particular the International Federation of Surveyors (IFS), the International Society for Photogrammetry (ISP) and the International Cartographic Association (ICA).

The Topographical Service is planning, as a further project, to carry out a comprehensive cadastral survey

on the scales 1:5,000 and 1:2,000. This task will be greatly facilitated if as a result of current negotiations with the French Government the annex of the French National Geographical Institute is transferred to the Topographical Service.

To provide for the future and compensate for the lack of technicians, the Topographical Service is sending a large number of student engineers to the world-famed National Geographical Institute in Paris, where they will receive excellent training in cartography, photogrammetry and surveying.

It was in this spirit that Morocco, which takes a keen interest in developments in the field of cartography, has delegated us to represent it in the work of the Third Conference at Bangkok, at which we are sure we will receive valuable advice that will enable us to continue and to improve the work we have begun.

STATUS OF CARTOGRAPHIC ACTIVITIES IN THE PHILIPPINES¹

GENERAL

This report is intended to cover the period from the First United Nations Regional Cartographic Conference for Asia and the Far East, held in India in 1955, as there was no official delegate to the Second Conference held in Japan in 1958, although an observer was sent by the Philippines to the latter Conference.

It is best to begin this report with a description of the organizational structure of the cartographic activities in the Philippines. Under the present set-up, there are around twenty-eight agencies of the Philippine Government which to a certain degree are engaged in the various branches of cartography. The Bureau of Coast and Geodetic Survey under the Department of National Defense is the principal cartographic agency of the Government, and is responsible for charting the territorial waters and mapping the coasts. The Corps of Engineers and the Philippine Air Force, also under the Department of National Defense, are engaged in land mapping and aerial photography, respectively. Although the cartographic functions of these two latter agencies are mainly for satisfying defence requirements, they are extended to civilian needs to some degree. The Bureau of Mines, under the Department of Agriculture and Natural Resources, does the topographic mapping of the country. Other bureaux and offices in the Philippine Government also execute surveying and mapping to satisfy their particular requirements. The following are the bureaux and offices listed under each Department, including addresses, heads of offices, and their respective concern in cartography.

A. Department of National Defense:

1 Bureau of Coast and Geodetic Survey, Manila

Director: Captain Angel G. de Jesus

- (a) Geodesy and geodetic surveys;
- (b) Topography;
- (c) Hydrography;
- (d) Geomagnetism;
- (e) Photogrammetry;
- (f) Surveys using electronic methods and devices;
- (g) Aeronautical charts;
- (h) Magnetic maps;
- (i) Gravity maps

- 2 Corps of Engineers, AFP, Quezon City
Chief of Engineers: Colonel Paulino S. Torio
 - (a) Topography;
 - (b) Surveys using electronic methods and devices.
- 3 Philippine Air Force, AFP, Pasay City
Commanding Officer: Brigadier-General Pedro Q. Molina
- 4 Research and Development Center, Quezon City
Chief: Colonel Constancio Velasco

B. Department of Agriculture and Natural Resources:

- 1 Bureau of Fisheries, Diliman, Quezon City
Director: Mr. Jose Montilla
 - (a) Hydrography;
 - (b) Land use maps (fishpond areas);
 - (c) Topical maps (fisheries maps).
- 2 Bureau of Forestry, Manila
Director: Mr. Tiburcio S. Severo
 - (a) Photogrammetry and photo-interpretation;
 - (b) Soil maps;
 - (c) Land use maps;
 - (d) Forestry and land classification maps.
- 3 Bureau of Lands, Manila
Acting Director: Mr. Nicanor G. Jorge
 - (a) Geodesy and geodetic surveys;
 - (b) Cadastre or cadastral surveys;
 - (c) Photogrammetry;
 - (d) Surveys using electronic methods and devices;
 - (e) Land use maps (town plans);
 - (f) Other topical maps (town planning, etc.).
- 4 Bureau of Mines, Manila
Director: Mr. Benjamin M. Gozon
 - (a) Topography;
 - (b) Geomagnetism;
 - (c) Photogrammetry and photo-interpretation;
 - (d) Geological maps;
 - (e) Topical maps (geological and mineral).
- 5 Parks and Wildlife Office, Manila
Director: Mr. Vicente de la Cruz
 - (a) Land use maps (parks and wildlife)
- 6 Bureau of Soils, Manila
Director: Mr. Ricardo Marfori
 - (a) Geological maps;
 - (b) Topical maps (soil maps);
 - (c) Photogrammetry and photo-interpretation.
- 7 Reforestation Administration, Quezon City
Administrator: Mr. Jose Viado
 - (a) Soil maps;
 - (b) Reforestation maps.

¹ The original text of this paper, submitted by the Philippines, appeared as document E/CONF.36/L.74

C. Department of Public Works and Communications:

1. Bureau of Public Highways, Manila
Commissioner: Mr. Nicolas L. Cuenca
 - (a) Geological maps;
 - (b) Land use maps (transportation);
 - (c) Other topical maps.
2. Bureau of Public Works, Manila
Director: Mr. Julian A. Buenda
 - (a) Topography;
 - (b) Hydrography;
 - (c) Photogrammetry;
 - (d) Geological maps.
3. Civil Aeronautics Administration, Pasay City
Administrator: Colonel Urbano B. Caldoza
 - (a) Aeronautical charts;
 - (b) Aeronautical information;
 - (c) Airport public works;
 - (d) Airport construction surveys.
4. National Waterworks and Sewerage Authority, Manila
General Manager: Mr. Susano R. Negado
 - (a) Topography;
 - (b) Geological maps;
 - (c) Hydrology

D. Office of the President:

1. National Planning Commission, Manila
Director: Mr. Anselmo T. Alquinto
 - (a) Town planning
2. National Economic Council, Manila
Chairman: Mr. Jose C. Loacin
 - (a) Land use maps (miscellaneous);
 - (b) Topical maps (industrial maps, land use and transportation maps, etc.).

E. Office of Economic Coordination:

1. National Power Corporation, Manila
Manager: Mr. Filemon M. Zablan
 - (a) Topography;
 - (b) Geological maps;
 - (c) Land use maps.
2. National Resettlement and Rehabilitation Administration, Manila
Manager: Mr. Bruno Q. Aparri
 - (a) Miscellaneous topical maps.
3. Manila Railroad Company, Manila
Manager: Lieutenant-Colonel Teofilo Zosa
 - (a) Topography;
 - (b) Transportation maps.
4. Philippine Air Lines, Manila
President: Mr. Miguel Campos
 - (a) Aeronautical charts;
 - (b) Transportation maps.

F. Department of Commerce and Industry:

1. Bureau of the Census and Statistics, Manila
Director: Mr. Manuel E. Buenafe
 - (a) Land use maps (miscellaneous);
 - (b) Topical maps (census and other physical data).
2. Weather Bureau, Manila
Director: Mr. Roman L. Kintanar
 - (a) Geomagnetism;
 - (b) Topical maps (climatic maps).
3. Board of Travel and Tourist Industry, Manila
Acting Commissioner: Mr. Augusto D. Resurreccion
 - (a) Topical maps, such as transportation and tourist maps.

G. National Science Development Board:

1. National Science Development Board, Manila
Chairman: Mr. Paulino Garcia
 - (a) Planning of research and development of survey instruments

2. National Institute of Science and Technology, Manila
Commissioner: Mr. Canuto Manuel
 - (a) Standardization of distance measuring instruments.

H. University of the Philippines:

1. Industrial Research Center, Diliman, Rizal
Head: Mr. Norberto S. Vila
 - (a) Soil maps;
 - (b) Research on instruments.
2. Forest Products Research Institute, Laguna
Director: Mr. Eugenio de la Cruz
 - (a) Research on paper.

CO-ORDINATION OF SURVEYING AND MAPPING

The Philippines felt that all surveying and mapping activities, instead of being dispersed, should be co-ordinated into a nationally integrated plan for the purpose of satisfying the country's cartographic requirements. The execution of surveying and mapping through a co-ordinated and co-operative effort would serve to pool the country's resources in personnel and finances to achieve these requirements. Under this plan, duplication of activities in most if not all of the branches of cartography would be reduced or eliminated and the country's resources would thereby be employed to fuller advantage.

Several attempts have been made towards effective co-ordination in the field of cartography in the Philippines but the most successful was the creation of the Board of Technical Surveys and Maps in 1960. This Board is composed of cabinet members managing the offices engaged in surveying and mapping and private representatives of the civil engineering and surveying professions. As embodied in its charter, the Board co-ordinates the surveying and mapping activities of the Government, and is the office entrusted with national policies affecting surveying and mapping. The general objectives of the Board of Technical Surveys and Maps are as follows:

- (1) To accelerate the production of maps and charts needed for the economic development of the country;
- (2) To improve surveying and mapping methods and techniques through research, development and training;
- (3) To standardize surveying and mapping methods and techniques;
- (4) To co-ordinate the budgetary requirements of the different surveying and mapping agencies of the Government.

As designated by the Board, all the bureaux and offices engaged in surveying are under the co-ordination of the Board of Technical Surveys and Maps. The Board is located at 234 Tanduay, Manila. The present Vice-Chairman and Executive Director is Commander Marcelino S. Tabin.

STATUS OF SURVEYING AND MAPPING

Control surveys

The earlier requirements of surveying and mapping for coastwise navigation in the Philippines were concentrated on the establishment of controls close to the shore lines. As of 31 December 1960, the existing horizontal control over land areas covers only about 10 per cent of the territory of the country, which indicates the necessity of a long-range plan for the establishment of controls.

A co-operative effort is being planned whereby the Bureau of Coast and Geodetic Survey will be assisted by

the Bureau of Lands and the Army Corps of Engineers in accelerating the establishment of controls. The Bureau of Lands requires a high density of controls for its cadastral surveys.

Topographical maps

The topographical maps of the Philippines are issued in series ranging in scale from 1:200,000 to 1:1,000,000. Large-scale maps such as those on the scales of 1:25,000 and 1:50,000 have been compiled by the United States Army Corps of Engineers. Lately, these topographical maps have been restricted. However, due to the efforts of the Board of Technical Surveys and Maps, a civilian edition of a map on the scale of 1:50,000, based on the military edition, is in the process of production.

Hydrographic surveys

The basic hydrographic surveys of Philippine waters were undertaken by the United States Coast and Geodetic Survey. This work was started as early as 1902. This responsibility was turned over completely to the Philippine Bureau of Coast and Geodetic Survey in 1950.

Since the first United Nations Regional Cartographic Conference for Asia and the Far East, where a report was rendered by the Philippine delegation, hydrographic surveys executed in the Philippines have been mostly revision or verification surveys.

Hydrographic surveys of inland waters are executed by the Philippine Bureau of Coast and Geodetic Survey in co-operation with other government technical agencies.

Aeronautical charts

Aeronautical charts for the Philippines were originally published before the war in restricted edition by the United States Coast and Geodetic Survey, Manila Field Station. During the Second World War, this responsibility was shifted to the United States Air Force which later became the agency producing charts for the Philippines both for their own use and for sale on the basis of diplomatic arrangements made some twelve years earlier. In 1957, this arrangement expired and it was incumbent upon our Government to take over the functions of publishing the country's aeronautical charts.

The Philippines, at present, still uses aeronautical charts which are printed in the United States.

The Bureau of Coast and Geodetic Survey now has on its budget a new aeronautical chart section. Although the production of aeronautical charts is not its basic function, it has nevertheless started to produce them upon the request of the Civil Aeronautics Administration. The Civil Aeronautics Administration is the agency responsible for the safety, regularity and development of civil aviation; however, it does not have the funds and facilities to produce the aeronautical charts required.

The preparation of aeronautical charts is necessary not only to meet our own requirements but also to comply with our international obligation as a member of the International Civil Aviation Organization (ICAO) under which we are committed to produce our own aeronautical charts.

Economic maps (topical maps)

In planning the development of the country's natural resources, economic maps dealing with mineral, forest, land, fishery and other resources are indispensable.

Economic maps made by a number of governmental agencies are primarily designed for their own use and only a few agencies, such as the Bureau of Soils, publish maps for general distribution. If the printing of these maps is undertaken by any of the agencies engaged in mapping and surveying under the co-ordination of the Board of Technical Surveys and Maps, considerable savings will be effected. At present, the Philippines is preparing for the production of various kinds of economic maps.

Geological maps

We now have sufficient geological data from the Bureau of Mines, the Bureau of Soils, NAWASA, the Bureau of Public Works and others to compile and print multi-coloured up-to-date geological maps which will cover the whole country systematically. The scale and type as well as other specifications will be decided by the using agencies working as a group.

IMPROVED METHODS AND TECHNIQUES

Recent improvement in surveying methods and techniques used by the Philippines include the use of electronic equipment, such as the tellurometer and the geodimeter. A ten-kilometre base line which will be used for calibrating this equipment is being established through a co-operative effort of the Bureau of Coast and Geodetic Survey, the Bureau of Lands and the National Institute of Science and Technology.

Notable among the projects in surveying and mapping is the numerical photogrammetric cadastre of the Bureau of Lands. A big province in Luzon has already been surveyed by this method and, with the initiative of the Board of Technical Surveys and Maps, cadastral surveys will include contours in order to save the cost of topographic mapping.

As promulgated by the Board of Technical Surveys and Maps, the Philippines has just adopted a plane co-ordinate grid based on the Transverse Mercator system. The adopted grid has its x axis on the equator and five central meridians at longitude 117° E, 119° E, 121° E, 123° E, and 125° E.

ANNEX

GEODESY

The triangulation work carried out during the past three years covers only a limited area. Apart from a few projects intended for the extension of horizontal controls, most of the new surveys had as their primary purpose the control of hydrographic surveys of important harbour charts. Seven projects were completed during the period.

Gravity work in the Philippines has just started. All the previous observations were made by visiting scientists, but these were not sufficient in number to serve as control points. An extensive gravity base reference station network has been recently established in the Philippines by the United States Army Map Service. About forty gravity base stations have been established and plans are now being devised for about 400 gravity stations to be established throughout the islands by the Philippine Coast and Geodetic Survey and by private contractors.

The Philippine Magnetic Observatory continued to operate and has contributed to numerous international projects and organizations. The periodic field magnetic survey was started in 1959 and it is estimated that it will be completed next year.

In connexion with the establishment of astronomic stations in the Far East, first-order astronomic latitude and longitude observations were completed at four designated triangulation stations in the Philippine area.

Seven primary tide stations are in operation in the Philippines to provide not only mean tidal values at oceanographically significant points, but also an accurate determination of the datum for vertical control at important centres of population.

NAUTICAL CHARTS

Due to the lack of sufficient funds for extensive survey operations, hydrographic survey work in the Philippines was confined mostly to important ports and harbours. In some sections of the country, where hydrographic data were needed for various economic development projects, the survey operations were made possible with assistance, in the form of fuel and supplies, from the private enterprises that made the requests. In areas where wrecks and other under-water obstructions have been cleared by salvage companies, wiredrag operations were undertaken to determine the extent of the salvage work and also to obtain depth clearances.

A significant help to the hydrographic survey operations in the Philippines will be the two new survey vessels which were generously offered by the Australian Government under the SEATO Economic Assistance Pact and which are now being constructed. The use of these vessels will, to some extent, accelerate the updating of the 168 different nautical charts being produced and will make possible the production of needed charts of newly developed ports and harbours.

AERONAUTICAL CHARTS

An Aeronautical Chart Section was established in the Philippine Coast and Geodetic Survey in 1960. Ten instrument approach charts and four landing charts have been compiled. There are so far 110 airports in the Philippines. The compilation of the series of World Aeronautical Charts, ICAO, on the scale of 1:500,000 has already been started.

TOPOGRAPHIC MAPS

Printing has been started of the revised 1:250,000-scale topographic map series which consists of fifty-five sheets and which is designed

to replace the less accurate 1:200,000-scale map series at present being produced. An initial move has also been made to produce the 1:50,000-scale topographic map series consisting of about 275 sheets.

Controlled photomosaics of the important watershed areas for use in irrigation, river control and other economic development projects now cover roughly 91,000 square kilometres, approximately 30 per cent of the country's land area. The photo-topographic mapping of the proposed site of the railway extension line covers about 500 square kilometres.

CADASTRAL SURVEY

The plan of accelerating cadastral surveys by the use of aerial photogrammetric methods is being implemented. A pilot project on this method is nearing completion and its results will determine the economy and practicability of its use in comparison to classical ground survey methods in the cadastral survey of the whole of the Philippines.

CONCLUSION

While some progress has been achieved in the charting and mapping of the country, the production and updating of all maps and charts of the Philippine Archipelago, consisting of more than 7,000 islands, is still a tremendous task to be performed. We are seeking possible means of accelerating the production of accurate and up-to-date charts and maps necessary for the economic development of the country. Perhaps the establishment of a regional inter-governmental cartographic organization, having as its main objective the assisting of any nation deficient in mapping requirements, and of a training centre designed to train geodetic and hydrographic engineers and personnel, would provide the best solutions to the problems that now beset mapping agencies.

PROGRESS OF KOREAN MAPPING¹

I. MAPPING IN ANCIENT TIMES

Korea has been producing some form of map since the Sam Kook reign (three nations reign) about 1,500 years ago. Ko Ku Ryo (one of the three nations) was the first to produce maps for distribution to major military forts throughout the land for national defence and safety. Korea has historic records which show that about A.D. 620, King Ryung Ryu, in the reign of Ko Ku Ryo, produced Bong Yok Do, which are similar to maps, and that about A.D. 540, King Jin Hung, in the reign of Silla (another of the three nations) established national guard monuments along the boundary, where all the topographic records were described. Korea also has a Chum Song Dae (astronomical observatory), the oldest astronomical observatory in the Far East, which was installed by Queen Sun Dok in the reign of Silla. Korean history says that the Bonze, Kwan Lok, in the reign of Baek Jae (one of the three nations) introduced a Chun Mun Ji Li Ji (astronomical and geographical publication) to Japan. Some centuries after that, the Koryo government (A.D. 935-1392) approved the organization of a geographic section under government supervision. Officers who passed examinations were assigned to research astronomical theory, atmospheric phenomena, map production, etc. The Koryo government introduced Ko Ryo Do (Korea Map) to Sir Jin Hi in the reign of Song (China). During the Li Jo reign, which began in 1392, Pung Su Ji Li Soul (one of the famous religions that lays down the principle

that the destiny of all people depends on the great power of a natural god, such as wind or geographical terrain) was very popular, and, in accordance with this religion, the people of that time produced many topographic maps, especially sheets showing mountains. Sir Kim Sa Hyung and Lee Mu in 1402 produced Hon Il Kang Li Do, topographic maps covering all of the Korean terrain, including China and Japan, using the paintbrush method. A few years later, Sir Sin Suk Ju, in the reign of the great King Sae Jong, revised both the pre-published maps and the newly-published Hae Dong Jae Kook Jyun Do, which were more advanced than previous works. However, certain cultivated persons who had been influenced by the more highly developed western civilization, produced modernized maps using compass and cloth-made measuring scales bought at personal expense. Sir Joung Han Ryung produced Pal Do Bun Hap Do, and Sir Kim Jong Ho produced Dae Dong Yu Ji Do (Great Eastern Map) and Chung Gu Do (Green Hill Map), which are now evaluated as national treasures. For the remarkable production of the Dae Dong Yu Ji Do, Sir Kim Jong Ho made a field check, or reconnaissance, by walking, in order to revise the pre-published maps; as a result of the many errors found in the details on the pre-published map sheets, he decided to produce more accurate maps, including Pal Do Do. He travelled throughout Korea for ten years and climbed Mount Paik Du, the highest mountain in Korea, seven times. He engraved original information sources on wooden boards for duplicating. Through his efforts, more valuable map sheets were published. The Dae Dong Yu Ji Do was divided into twenty-two local

¹ The original text of this paper, submitted by the Republic of Korea, appeared as document E/CONF 36/L 75.

districts, each district being contained in one booklet; the size of each district was 120 li (48 kilometres) in length and 80 li (32 kilometres) in width. At every 10 li (4 kilometres), latitude and longitude similar to the modern grid system were described for convenient reading of the locations and distances of all features. This map was completed in 1858 and was prepared at a scale of 1:162,000. Following this map, the Jo Sun Pal Do Do (Administrative District Map) was produced in 1910.

II. MODERN MAPPING PROJECTS

A partial mapping project by the Japanese

The Japanese Government initiated systematic surveying in Korea in 1869 and organized survey parties to perform rough surveys of the chief coastal zones and shorelines of the country. From 1872 to 1891 tour guide maps covering the main roads were also published by the Japanese. During 1893-1894, 1:200,000 maps of Korea were compiled by the Japanese Imperial Land Survey, based on these rough surveys, guide maps and subsequent surveys. The early Japanese land surveys were conducted mainly by measurement and with instruments such as the compass and the barometer. Elevations on these maps were indicated by contour lines, whose intervals were not accurately determined by spot elevations. In 1895, Japan dispatched the provisional survey sections, consisting of three units and a headquarters detachment, to accomplish a basic survey of Korea. The survey section produced the equivalent of fifty-four 1:50,000-scale sheets, using the plane table method without adequate control points.

Mapping project by Hanguok (recent Korea)

In 1900, the Hanguok (Korean) Government established a surveying section under the supervision of the Tak Ji Bu

(equivalent to the present Geographic Research Institute) for ensuring the accuracy of boundaries of land belonging to the people, and started to measure areas with the available surveying equipment. In 1908, the Tak Ji Bu was reorganized as the Jae Won Jo Sa Kuk (National Resources Research Institute), with plans to survey large areas; however, only part of the work was done. In 1909, surveying teams were organized with qualified technicians for the development of a modern topographic unit. In January 1910, the Tak Ji Bu established the Land Research Institute for the further improvement of the modernized topographic units under the seven-year long-range project programme.

III. TOPOGRAPHIC PROJECTS BY THE JAPANESE GOVERNMENT DURING THE OCCUPATION OF KOREA

A topographic project was started for tactical and economic reasons by the Japanese Government.

The Japanese performed base line surveying for planimetric data in thirteen areas of Korea from 1910 to 1913, using measuring tapes twenty-five metres in length. The acceptable error was 1:3,000,000, while the permissible error was within 1:500,000. Control datum was in accordance with the Japanese datum, using the Bessel spheroid.

During the period 1910-1915, several thousand horizontal control points were established on first, second, third and fourth orders. From 1910 to 1915, bench-marks were established along main roads at an average interval of 204 kilometres. A total of 2,823 were located throughout the country, 687 of them in South Korea. Original bench-marks in the Inchon area are at a height of 5.84 metres above mean sea level and those in Mok Po, 2.155 metres. The following table gives a detailed classification of the control points.

	Order				Total
	First	Second	Third	Fourth	
South Korea	192	1,125	3,492	11,672	16,461
North Korea	207	1,254	3,104	13,168	17,733
Total	399	2,379	6,596	24,840	34,194
Period established	1910-1913	1910-1914	1910-1915	1910-1915	
Price per point (yen)	593	209	32	In accordance with the price when established	
Average length of side (kilometres)	30	10	5	2.5	
Average length of side in Japan (kilometres)	45	8	4	2	
Average length of side in USA (kilometres)	30-150	10-60	1-15	None	
Average side angle	60°	30°	25°		

From 1909 to 1920 the mapping service was expanded to produce 728 topographic map sheets at 1:50,000, using the polyhedral solid planimetric plotting method, 303 1:12,500-scale map sheets and 1:10,000-scale city plans for the main cities. The map sheets were reasonably accurate and reliable; they were printed in monocolour but could not be distributed in large quantities on account of the poor reproduction facilities available at that time. These map sheets were used only for military operations and not for industrial or civilian use. At the end of the Second World War, the Japanese Imperial Army Map

Service was partially revising pre-published maps and maintaining horizontal and vertical control points.

IV. MAPPING PROJECTS BY THE REPUBLIC OF KOREA AT THE END OF THE SECOND WORLD WAR

In September 1945, mapping source materials kept by the Japanese Land Survey Institute were returned to the Korean Government by the Allied Forces. The Civil Engineering Bureau and the Ministry of Home Affairs made plans to improve the mapping field. However, shortages of equipment and technical knowledge have been

the main obstacles to that goal. With the outbreak of the Korean conflict in 1950, the mapping requirements for military operations were greatly increased. To fulfil these requirements, the South Korean Government transferred this responsibility from the Ministry of Home Affairs to the Ministry of National Defense. The Korean Army Map Service was established and staffed by many capable technicians. Modern equipment and the latest techniques were received from the United States of America. With the source materials obtained from the Japanese Government and with qualified technicians, the Republic of Korea Army Map Service produced 1:50,000-scale topographic map sheets in monocolour. However, the source materials were so old that the features on the final compilation were not suitable for modern requirements. To resolve these difficulties, the Republic of Korea Army Map Service compiled new maps, at 1:100,000 in six colours, at 1:50,000 in five colours and at 1:25,000 in four colours. With technical assistance from the United Nations Forces, the Korean Army Map Service also revised 60 per cent of the features on the old Japanese source maps. These map sheets were utilized by the Korean Army and played an important part in the Korean conflict.

V. MAPPING PROJECTS AFTER THE KOREAN CONFLICT

Upon the establishment of the armistice agreement between the United Nations Forces and the North Korean Army in 1953, mapping requirements for the reconstruction of civil engineering projects damaged during the war and for the development of industries were increased. Although the Republic of Korea Army Map Service has done its best to continue to fulfil civilian mapping requirements, it has not been able to do so and still perform its primary function of producing military maps. With this in mind, the Republic of Korea Government established the National Construction Research Institute (formerly the Geographic Research Institute) under the National Construction Bureau in September 1958 to carry out civilian industrial mapping projects. These two mapping agencies, the Republic of Korea Army Map Service and the National Construction Research Institute, have closely co-operated for the further improvement of mapping in Korea.

Below are listed the mapping projects carried out by the Army Map Service since the Korean conflict.

Control point maintenance

The Republic of Korea Army Map Service has been re-establishing 30 per cent of the destroyed control stations and re-covering 50 per cent of the damaged control stations through the use of survey parties.

Map compilation

With the application of the Transverse Mercator projection method, aerial photography and the latest techniques, the Map Service has made remarkable improvements in mapping compared to the old compilation method. Multiplex equipment, reflecting projectors and drafting equipment are expected to be received in 1962, when more improvements are anticipated.

VI. PLACE NAMES ON MAP SHEETS

In accordance with the Joint Korean-American Map and Mapping Exchange Agreement, all place names are bilingual (Korean-English) on map sheets published for "co-utilization maps", that is, those to be used by the Korean and United Nations Forces. Upon the establishment of the National Construction Research Institute, the Korean Government organized a central place names committee to re-establish or unite administrative place names throughout Korea.

VII. MAP PRODUCTION

The Republic of Korea Army Map Service has reproduced and maintained the following tactical and other maps.

Scale and type of map	Estimated total coverage	In hand	Number of colours
	(Map sheets)		
1:25,000 topographic map	2,710	1,010	5
1:50,000 topographic map	721	720	5
1:100,000 topographic map	204	142	6
1:250,000 topographic map	27	27	6
1:500,000 road map	8	8	5
1:1,000,000 topographic map	1	1	6
1:10,000 city plan	5
1:125,000 city plan	...	30	5
1:30,000,000 world map	...	2	9
1:11,000,000 world map	12	12	9

REPORT ON PROGRESS ON CARTOGRAPHIC PROJECTS IN SAUDI ARABIA¹

Prepared by Abdel Karim Ghalayini, Ministry of Petroleum and Mineral Resources

I. Geographical and geological mapping projects

This part of the report gives a brief outline of the progress of the geographical and geological mapping project which has been planned for the Arabian Peninsula. The project to publish 1:500,000-scale geographical and geological surface maps for all of Saudi Arabia was initiated in 1954 by the Arabian American Oil Company in co-operation with United States Geological Survey under the joint sponsorship of the Kingdom of Saudi Arabia and the United States Department of State. The Kingdom was divided into twenty-one quadrangles,

¹ The original text of this paper, submitted by Saudi Arabia, appeared as document E/CONF.36/L.26.

seventeen covering an area of three degrees by four degrees and four covering a slightly larger area. Twenty-one separate geological maps and twenty-one separate geographic maps will be published. These maps are bilingual, in Arabic and English, and cover an area, including the Kingdom and adjacent territory, of approximately 1,165,000 square miles. The Arabian American Oil Company is responsible for mapping the sedimentary rock area totalling fourteen and one-half quadrangles, and the United States Geological Survey is responsible for mapping the crystalline rock area of six and one-half quadrangles.

1:500,000-scale geographical and geological maps

At the present time the Kingdom of Saudi Arabia has been completely covered by high-altitude vertical aerial photography. This again was a joint operation by the Saudi Arabian Government and the Arabian American Oil Company. Because of the large area involved, it was decided that 1:600,000-scale photography would meet all mapping requirements. In the fall of 1949, Aero Service Corporation of Philadelphia, Pennsylvania, started photographing the Eastern Province of Saudi Arabia. A converted army B17 aircraft was used, because of its long cruising range, with a special Aero Service T11 camera having a six-inch focal length and metrogon lens. Photographs were taken from an altitude of 30,000 feet with the necessary forward and side lap to give complete stereoscopic coverage. Adverse weather conditions during the summer months limited the flying to a few short months in the winter. From 1949 to 1951, an area covering 275,000 square miles was photographed. The remaining area was flown in increments from 1954 to 1959. The total area flown was approximately 797,600 square miles.

In the great sand desert of southern Arabia, where visual flying is extremely difficult because of the terrain, Shoran controlled photography was used to establish flight line and photographic control for future use in the photogrammetric mapping programme. In north-west Arabia, this method was also used in photographing the rugged Hijaz area. Here, a Shoran trilateration net was established extending from the Jordan border south through the western and north-eastern section of Arabia. This net was tied into the European triangulation network and for the first time extended the European datum plane into Saudi Arabia. Controlled photomosaics at a scale 1:100,000 were made along the west coast of Arabia.

In eastern Saudi Arabia, both horizontal and vertical control is extensive. A third-order triangulation net and a second-order level net extends from the northern borders of Arabia south into the Rub' al Khali. This control has been developed over a period of fifteen years to establish adequate bases for documenting the vast amount of geological field work carried out. Astronomical observations were used in outlying areas not covered by triangulation. The observations were of high order using meridian transit stars, recording chronograph and chronometer. Stadia traverses and barometers were used to extend the level net. The Shoran photography in the Rub' al Khali was tied into the triangulation net.

High-order astronomic observations provided the major control in western Arabia. In 1956, the Shoran net was established in north-western Arabia to provide adequate control for the new photography in this area. A second-order level line was established by Aero Service Corporation extending in a north-south direction through central Arabia. This net originated in the north near the Saudi Arabian border and extended south into the south-western limits of the Rub' al Khali. This also tied in with the previous level lines, provided vertical control for the photography and established the bases for adjusting many barometer and stadia traverses throughout central Arabia.

When the 1:500,000-scale map project was implemented, it was decided that hachures would be used to represent the relatively low topography in the sedimentary area and that shaded relief, air brush method, would be used in the

more rugged area of crystalline rocks. Sand areas would be shown by hand stippling in order to present trends and types of sands as accurately as possible. The maps would be constructed on a Lambert Conformal Conic projection.

A programme was set up to photo-identify both horizontal and vertical control points, traverse stations and geological field stations. This required several field parties to retrace and relocate previous field work that had been done prior to aerial photography. At the same time, a programme to mark all future field control was carried out. Key triangulation, astronomical and level benchmark stations were marked with large asphalt circles in the sand areas or dragged circles on rough terrain. This method of marking stations proved very effective and also aided the pilots in navigating. All field traverses were adjusted, both horizontally and vertically, into the photography.

In the area covered by sedimentary rocks, the slotted templet method of laydown was employed, all horizontal control stations being used except those in the area covered by Shoran photography where geographic co-ordinates were computed for each photo centre. Utilization of these laydowns and laydown photographs in the field eliminated the need of any further horizontal control usually carried out by geological field parties. By photo-identifying stations in the field and resecting the stations on to the laydown, horizontal control adequate for documenting geological or geographical information was obtained.

In the western area, compilation was based mainly on vertical photography, trimetrogon photography, in part controlled and later corrected to the new vertical photography, and controlled photomosaics. All astronomical observation stations and vertical control stations were photo-identified and utilized in the compilation. Vertical photo coverage was delineated to provide the basis for the air brush method of representing topography. Since 1950, the Geological Survey has had several of its geologists working in the central and western areas of the Kingdom as special advisers on geology and ground water to the Ministry of Finance and National Economy. All field work, both geographical and geological, carried out by this group has been incorporated into the map project, as previously described.

In the 1:500,000-scale geologic map series, photo-geological interpretation was used extensively. This material was photogrammetrically compiled on to the existing geographic map bases. In the sedimentary area, this represented twenty-seven years of extensive surface geological mapping and in the crystalline area approximately nine years of surface work by Survey geologists, including other geologic mapping conducted by the Saudi Arabian Government.

At present, all work has been completed on both the geologic and the geographic 1:500,000-scale maps. Fifteen geographic and nine geologic maps have been published and the final publication date for all remaining maps is scheduled for mid-1962. (See figures 13 and 14.)

1:2,000,000-scale map of the Arabian Peninsula

In 1958, a preliminary edition of a 1:2,000,000-scale geographic map of the Arabian Peninsula, printed in both English and Arabic, was published. A revised edition of this geographic map and a new geologic edition at 1:2,000,000-scale will be published by the Geological

Survey of the United States Department of the Interior.

The accuracy of these maps is far superior to those previously available which primarily reflected the recordings of various explorers' traverses. Many important villages and topographic features are now mapped for the first time. The contribution by the Arabian American Oil Company of the results of many years of geological research within their concession area and data from the United States Geological Survey on other portions of Saudi Arabia represent a major addition to knowledge of south-western Asia. The large Arabian Peninsula map, at a scale of 1:2,000,000 and measuring 48 by 55 inches, has been issued as "Miscellaneous Geologic Investigations Map I-270-B". It was compiled as the base for a geologic map, still in preparation.

The new revised 1:2,000,000-scale geographic map will incorporate all the information on the 1:500,000-scale maps. Topographic representation will be shown by hachures and will incorporate all recent vertical photo-

graphy. This includes a complete revision of all culture place names, bathymetric lines, oilfields and oilfield facilities, etc. The map will be printed in both English and Arabic. The new 1:2,000,000-scale geologic map will also incorporate all the geology shown on the 1:500,000-scale series. The geology will be generalized on the new geographic base and will include geology for the entire Arabian Peninsula. The publication date for these two maps is scheduled for late 1962.

These maps are part of a programme to provide the Saudi Arabian Government with reliable data for an orderly scientific and economic development of the Kingdom. They represent the first results of a programme that has been in effect for the past eight years. The Kingdom is one of the few countries in the world to have been completely mapped by aerial photography. The accuracy and quality of topographic representation of these maps are such that they can be utilized in the planning and development of roads, towns, agriculture programmes and mineral exploration.

II. Persian Gulf survey

An integrated survey of the Persian Gulf is recommended in order to determine the coastline accurately and provide a basis for the partition of the Gulf. The need for an accurate determination of the boundary lines for the Gulf arises now on account of the growing economic importance of the area. A number of base ground stations are required on both sides of the Gulf, the positions of which should be expressed in co-ordinates of a recognized and acceptable common international datum. Another network of horizontal monumented stations on the periphery of the Persian Gulf will be established and tied directly to the new base ground stations, and will serve as reference points along the Persian Gulf coast.

The horizontal position of the mean low-water line needs to be ascertained in this survey for use as a base line which will be the origin of any offshore boundary determination.

The following discussion deals with the method and technique recommended for the completion of this survey.

PROPOSAL FOR AN INTEGRATED SURVEY FOR THE PERSIAN GULF

Method of survey

A trilateration network across the Gulf is the fastest, most economical and accurate method known at present. Stations of the network will be located in suitable positions on both sides of the Gulf and will be so constructed as to ensure their permanence. The trilateration survey method has been successfully used throughout the world and consists of measuring all distances in a given figure, in contradistinction to the measuring of angles and base lines in the triangulation. The survey must be of first-order accuracy with the error of length in a single measurement not greater than 0.0015 of a kilometre and of an average triangle closure not greater than $\pm 0.01''$. In order to ensure first-order results, the ratio of sides measured to new positions established must exceed three to one.

The distance measurement between stations on both sides of the Gulf will be made by a high-accuracy Hiran survey, using an aircraft and ground stations on both

sides of the Gulf. All lines will be measured by the well-known line crossing technique used in Hiran surveys. It is also recommended that two ground stations be established, one on Al' Arabiyah Island, the other on Al Farisiyah Island, to indicate their exact positions and to be used as reference stations for any future offshore work. The first-order azimuth determinations will be included in the survey whenever they are needed to strengthen the network.

This established trilateration network along the Gulf coast forms the basic control for any subsequent survey. It is proposed to establish a tellurometer traverse between the coastal trilateration stations, with traverse legs of about six kilometres. The tellurometer traverse supplies supplementary control between trilateration stations located fifty to 100 kilometres apart.

The tellurometer survey method utilizes high-frequency radio waves as a means of determining the distance between two points. The advantage and important feature of the tellurometer are that rough terrain or unfavourable weather does not hinder its use and measurements can be taken more quickly than with any other survey equipment. The traverse stations established by this method would then serve as basic horizontal control for any future surveys and will be used as reference points for determining the position of the mean low-water line.

Standard datum

A commonly recognized international datum must be used in this survey. In the Middle East two different data are used, European and Nahrwan. Several countries in the Middle East have been tied to the European datum and it is suggested that it be the one adopted. Surveys in Saudi Arabia, Iraq and other countries bordering the western part of the Persian Gulf are already tied to the Nahrwan datum (Clarke's 1880 spheroid) and the use of this datum is mainly restricted to the above-mentioned countries.

As the European datum is an internationally recognized and acceptable common horizontal datum, it is suggested that the aforementioned survey be tied to this datum.

Two base stations located in Iran—which are Safid and Parak trilateration stations—are tied to the European datum and are located near the Persian Gulf coast. These two stations would be a great aid in the implementation of this survey; all stations established along both sides of the Gulf could be tied to them.

Figure 15 shows the location of trilateration base stations in the Persian Gulf area which are tied to the European and Nahrwan data.

Mean low-water line

Determination of the mean low-water line is important for any offshore boundary survey since it serves as a base line from which the territorial sea or median line can be measured. The concept of using the mean low-water line in the determination of any offshore boundary is recognized internationally (as mentioned in *Law of the Sea*, published in 1958 as a result of the United Nations Conference in Geneva) and has been used in the determination of offshore boundaries in many countries throughout the world. The horizontal positioning of the mean low-water line on the survey maps is necessary for accurate offshore boundary determination. With present-day instruments the determination of this line is possible and it can be located with high accuracy in a short time.

For the accomplishment of this survey a system of tide gauge stations located around the perimeter of the Gulf must be established to provide accurate recording of the mean low-water level required for photography. The total circumference of the Persian Gulf will be photographed at such times as the tide stations register a mean low-water level. This photography will be controlled by the use of tellurometer traverse stations with supplementary photogrammetric control points established along the periphery of the Gulf.

A map at a suitable scale will be compiled from the aerial photography and the actual horizontal position of the mean low-water line as determined from the photographs will be located and plotted on it.

Figure 16 illustrates the mean low-water line on the Gulf coast between Damman and south Al-Khobar.

This survey will supply on a commonly accepted international datum the basic geodetic control, tidal information and maps, which, when approved by the Governments concerned, will be used for offshore determination in the Persian Gulf. This survey will serve as an accurate and reasonable basis for future as well as present boundary determinations.

SAUDI ARABIA AND BHARAIN OFFSHORE BOUNDARY SURVEY

The Governments of Saudi Arabia and Bahrain entered into an agreement on 22 February 1958, which in essence defines their jurisdiction in the Persian Gulf waters between the two countries' shorelines. In accordance with the agreement, a geodetic survey was carried out by the Aero Service Corporation in order to establish permanent reference points from which the areas in the Persian Gulf under their jurisdiction can be determined. The survey was accomplished by trilateration, and distance measurements were made by tellurometer.

The geographical locations of twenty-eight points were determined by trilateration based on two known base stations. In this network, eighty-five lines were measured ranging in length from 2 to 47 kilometres with an average of 22 kilometres. The position of two known base stations and the azimuth of the line between these stations were stipulated as the fixed conditions to be held in the adjustment. In addition to these fixed conditions, three first-order azimuth determinations were made in order further to strengthen the network. The majority of the lines had corrections of less than one part in 120,000. The position errors varied in latitude from ± 0.006 to ± 0.019 seconds and in longitude from ± 0.015 to ± 0.058 seconds. The check on the position error of the furthestmost point indicates an accuracy of the survey of one part in 76,000. The survey is tied to Nahrwan datum (Clarke's 1880 spheroid).

Field work on the project was commenced in February 1959 and completed in May of the same year. The results of the survey were submitted to both Governments in a detailed geodetic survey report which included the co-ordinates and a description of the boundary points.

III. Geophysical surveys

Geophysical survey methods are primarily used for the investigation and prediction of favourable subsurface geological structure which might act as traps for accumulations of oil and mineral deposits. At present, geophysical methods of exploration contribute much towards revealing deep geological structures not disclosed by surface geology.

A seismic survey was first introduced into the Eastern Province in 1937 by the Arabian American Oil Company, and gravity and magnetic surveys were introduced in 1939. Late in 1957, the Government of Saudi Arabia established a net of gravity bases in the Western Province which in turn is tied to accessible international gravity bases.

SEISMIC SURVEYS

At the present time, approximately 220,000 square miles are covered by reconnaissance and detailed seismic surveys, including 11,000 square miles offshore. Detailed seismic surveys were usually conducted in the most promising

areas of geological significance. Reflection or refraction methods were used in different parts of the area according to the nature of the subsurface formations. The method used depended upon the results obtained from experimental shootings conducted in each area.

As a result of the survey, seismic contour maps were prepared of the subsurface horizons which are considered as datum for subsurface structure mapping. At present, there are still three seismic parties performing seismic mapping in the most favourable parts of the Eastern Province.

GRAVITY AND MAGNETIC SURVEYS

In Saudi Arabia, gravity surveys were first applied in the Eastern Province in 1939 by the Arabian American Oil Company, at that time known as the California Arabian Standard Oil Company. At the end of 1958 most of the company concession area, which includes the eastern half of Saudi Arabia and the Rub' al Khali (about 440,000 square miles of sedimentary rocks), was covered

by a gravity survey and a magnetic survey. The first party to work in this area was contracted from the Matt-Smith Company of Houston, Texas. It started early in 1939 and worked until 1940. The Matt-Smith crew was replaced in 1940 by a company crew using a large La Coste-Romberg meter. Work by this crew was discontinued in December 1940 on account of the unsettled conditions in Europe. The rest of the gravity and magnetic surveys were conducted on a contract with the Robert H. Ray Company of Houston, starting late in 1947. The Worden gravity meter and the Ruska vertical magnetometer were used in these surveys. During 1949 and 1950 a small marine gravity survey was conducted along the coast from Nish'ab to the south of Jubail.

Results obtained from these gravity and magnetic surveys have aided a great deal in determining which areas of the vast country have favourable geologic conditions for oil trapping. Areas showing gravity and magnetic anomalies were then investigated more carefully.

Dr. G. P. Woollard of Woods Hole Institute set a base gravity station at Dhahran Airport in October 1949 (on the left side of the vestibule leading into the terminal building from the airfield) as part of his world-wide net of gravity bases. All gravity values in Saudi Arabia and related to Woollard's value at Dhahran Airport. Dr. Woollard also set secondary bases at Ras al Misha'ab and Abu Hadriya airstrips in November 1948, when he returned to check his original tie between Dhahran and

Tripoli. Permanent gravity bases were also established by the Company at different places in the concession area and along the road between Ras Tanura and Dharan to be used for meter calibration and gravity survey work.

A project for the establishment of a net of gravity base stations on a common datum throughout the Saudi Arabian Peninsula was also implemented by the Government of Saudi Arabia late in 1957. In Jeddah, a gravity base station has been established, tied directly to three international gravity bases, and used as a base station in this programme. In this long-range geodetic work, all surveys have been carried out by using air transportation; twenty-three new gravity stations have been established covering a change in gravity of about 1,250 milligals. Drift was corrected on the basis of repeat readings of the key stations immediately before and after flight. Upon the incorporation of these gravity data into a single net on a common datum, a Bouguer Anomaly gravity map was compiled for the Saudi Arabian Peninsula to indicate the gravity gradient and structure of the Arabian Shield.

ACKNOWLEDGEMENT

I would like to express my thanks to the staff of the Arabian American Oil Company Cartographic Section for providing assistance in the preparation of the first part of this report.

REPORT ON AERIAL PHOTOGRAPHIC ACTIVITY IN SAUDI ARABIA¹

Prepared by Hashim Shigdar, Ministry of Petroleum and Mineral Resources

Although cartographic activity has not yet been centralized in Saudi Arabia, mapping and aerial photographic programmes are mostly carried out by the Ministry of Petroleum and Mineral Resources. Before the Directorate General of Petroleum and Mineral Affairs was established in 1954, mapping was restricted to limited areas, mainly in the oil concession zone, and was carried out by the Arabian American Oil Company.

Aerial photography covering eastern and north-central Arabia in the concession area has also been completed by the oil company.

In addition, 50,000 square miles in the west-central and southern portions of the Arabian Shield have been mapped with aerial photography by a United States Geological Survey mission maintained in Saudi Arabia from 1950 to 1954. Aerial photographic maps of this area have been produced at a 1:100,000 scale measuring in size one degree longitude by 30 minutes latitude.

To speed up the mapping programme in Saudi Arabia, the Government late in 1955 contracted with the Aero Service Corporation to take aerial photographs of the western Arabian Shield under the auspices of the Directorate General of Petroleum and Mineral Affairs, which later became the Ministry of Petroleum and Mineral Resources. The area lies between the Jordan border in the north and the Yemen border in the south and extends from the Red Sea eastward as far as 46° longitude. A B17 plane equipped with a six-inch precision camera was used to take aerial photographs at a flying height

ranging up to 32,000 feet. Flights were spaced approximately six miles apart and extended unbroken from the Red Sea to the eastern boundary of the area. The aerial photographs have been controlled by fourteen geodetic Shoran stations established in the area.

This outstanding project was performed in four operational seasons (from January 1956 to November 1958) and covered 312,900 square miles in the western Shield area.

In addition, the Government, together with the Arabian American Oil Company, has contributed to taking aerial photographs covering 76,000 square miles in the south-central part of the country.

The approximate scale of the aerial photography of the western Shield area is 1:60,000. The advantage of these small-scale aerial photographs is that they can be satisfactorily used with precision stereoscopic instruments. They also permit a comparatively large area to be viewed stereoscopically; thus, continuity of geological features can more easily be recognized and associated with other significant features. Practically all the structural formations observable on large-scale photographs can also be seen on the 1:60,000-scale photographs through a stereoscope.

During the field operation the original set of contact prints prepared in the field was submitted directly to the Government for inspection of photo scale and overlap coverage. The scale of the photographs was determined by measuring a chosen distance on the ground (or on an available map) between two points that could be recognized on the photographs.

The average overlap of the successive photographs along

¹ The original text of this paper, submitted by Saudi Arabia, appeared as document E/CONF.36/L.27.

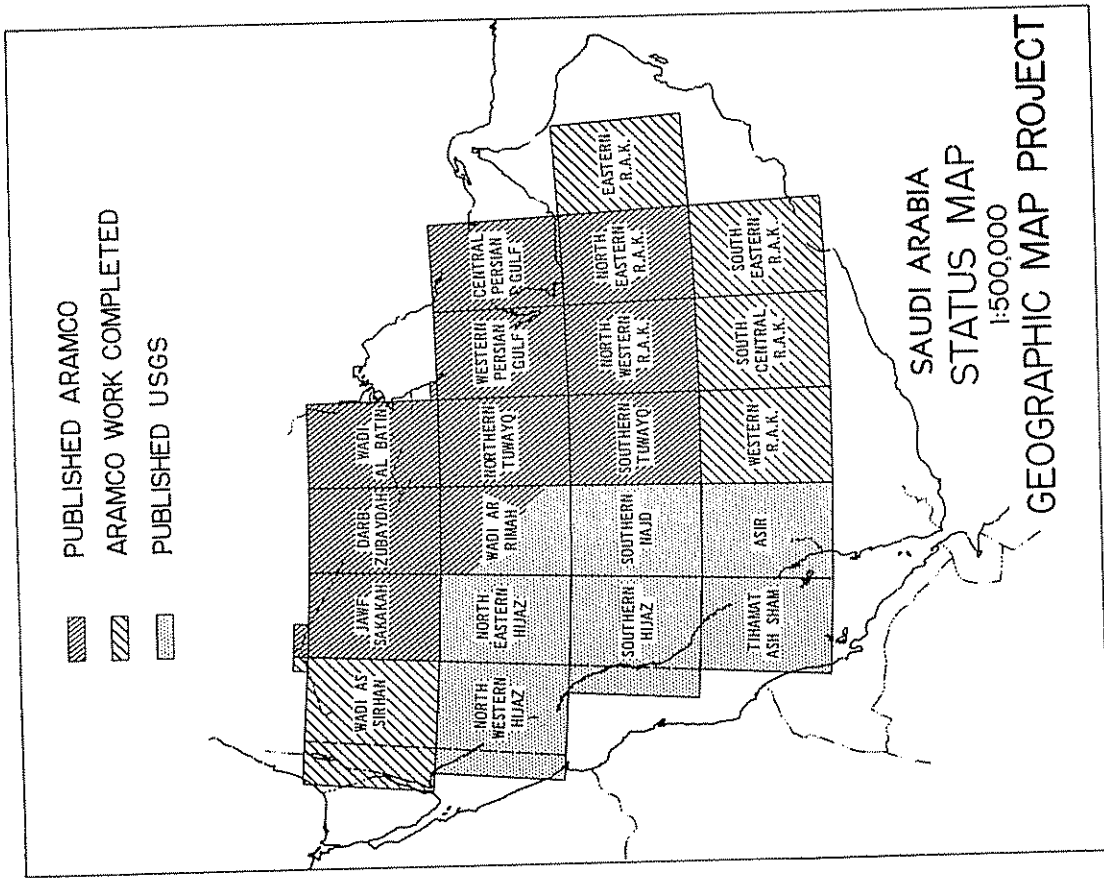

Figure 14. Saudi Arabia: Status map of the 1:500,000 geographic map project

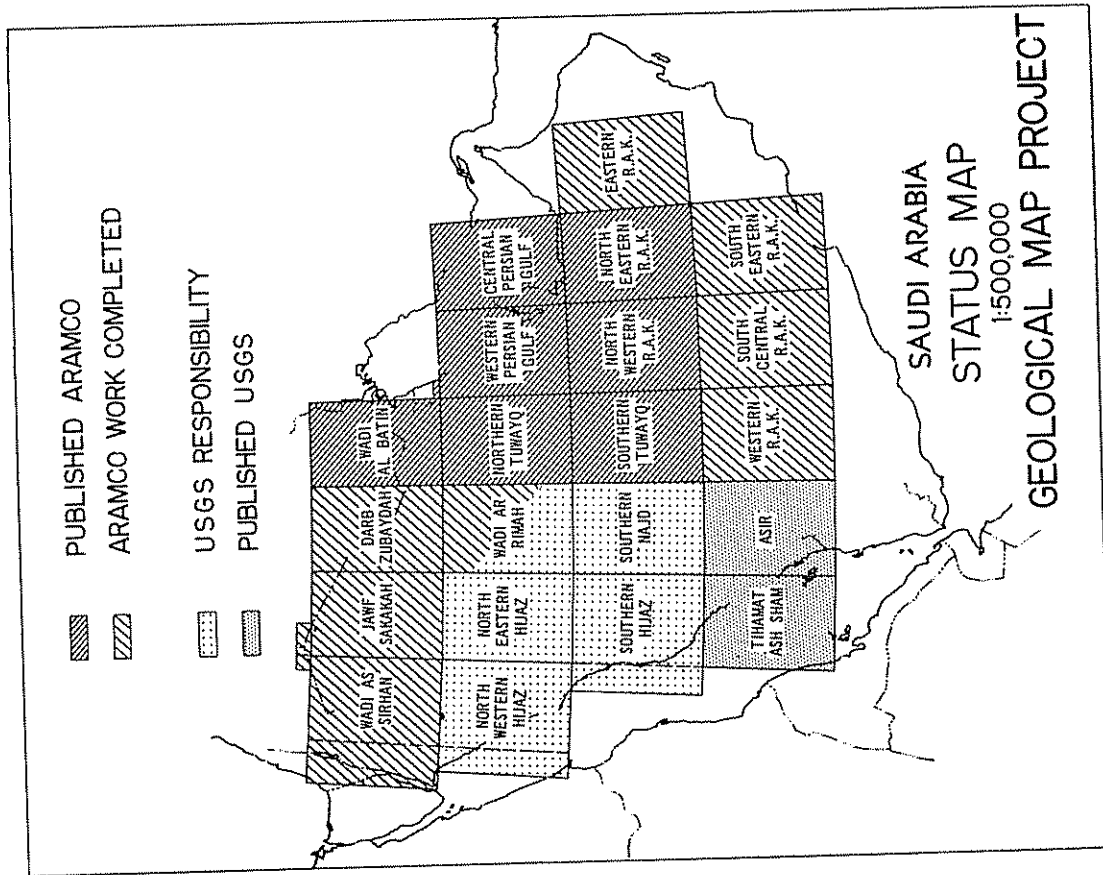

Figure 13. Saudi Arabia: Status map of the 1:500,000 geological map project

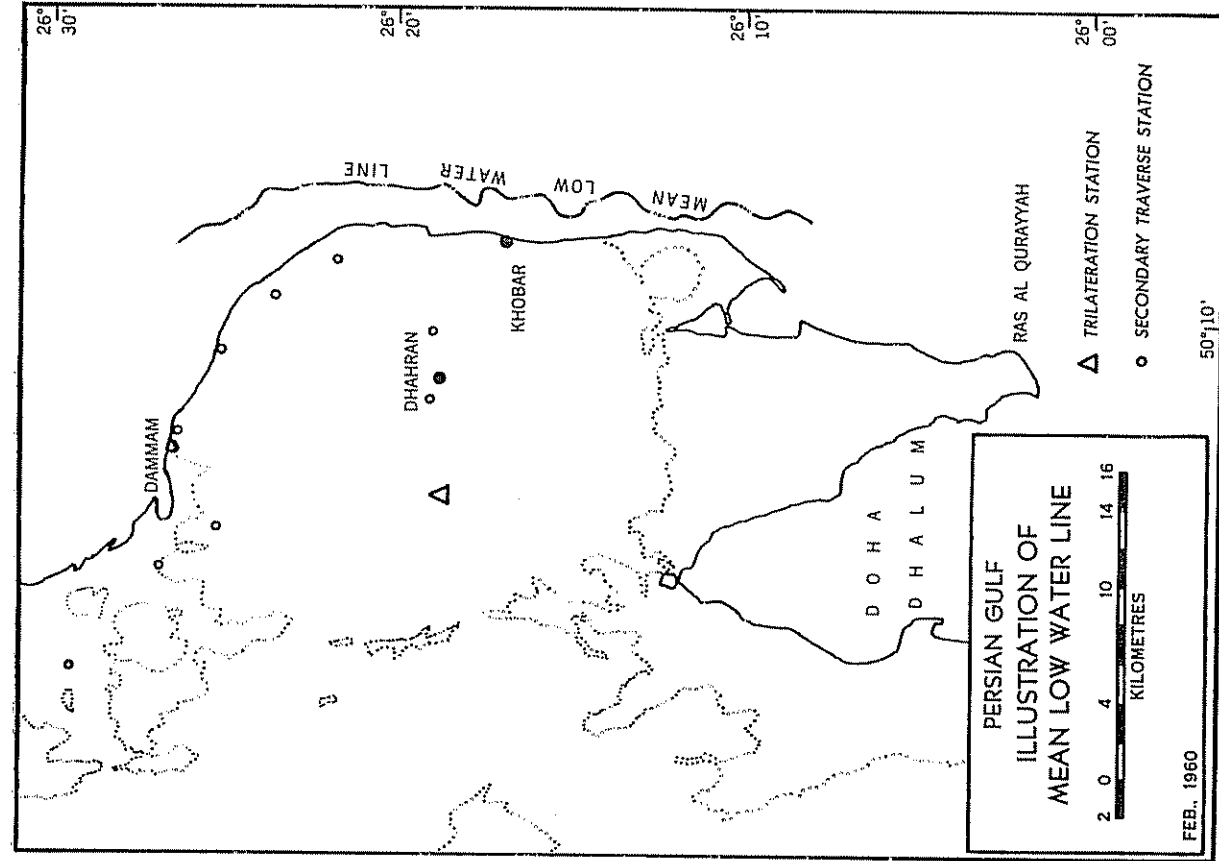

Figure 16. Persian Gulf: Illustration of mean low-water line

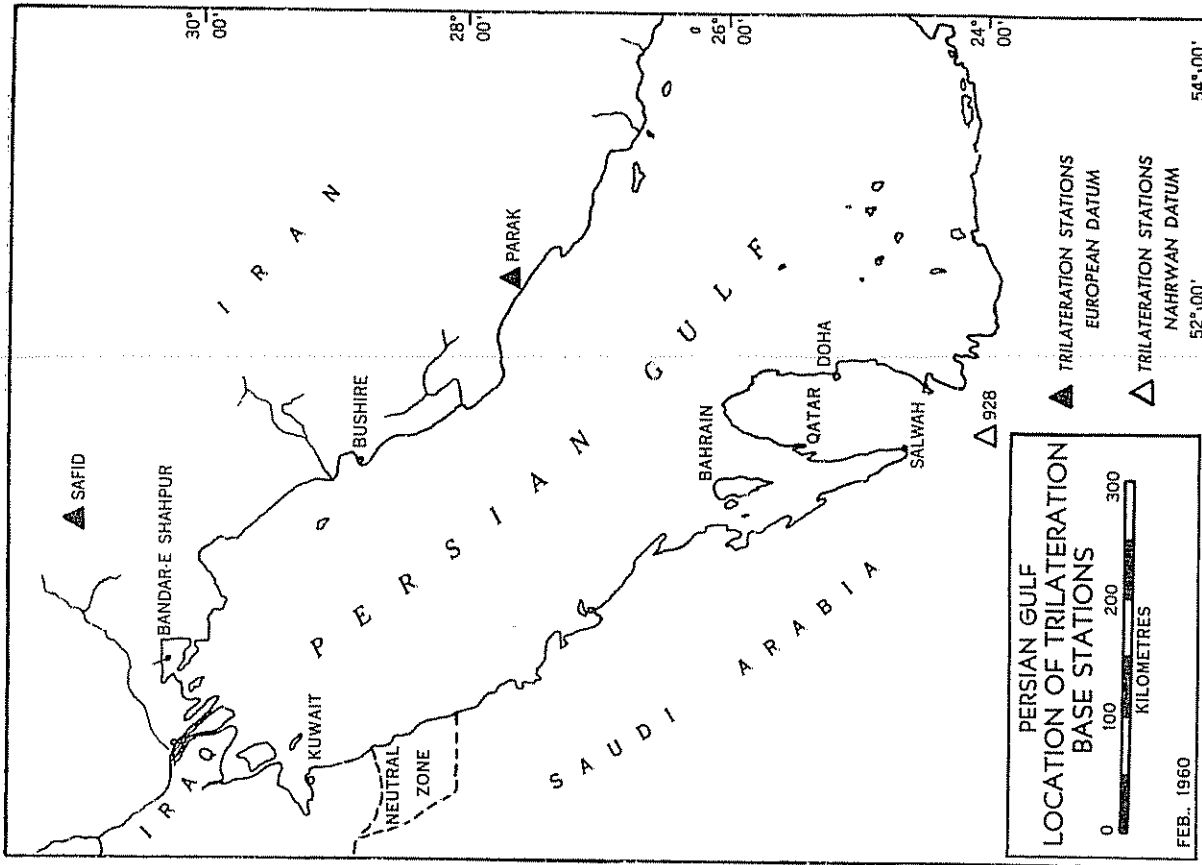

Figure 15. Persian Gulf: Location of trilateration base stations

the line of flight is 60 per cent with a minimum of 55 per cent and a maximum of 65 per cent. The average side lap between parallel flights is 30 per cent with a minimum of 15 per cent. Particular care was taken to reduce the tilt caused by the deviation of the camera axis from the vertical. The maximum tilt was one degree for the entire project.

On each photograph, the date and the number of the roll, the number of the exposure on the roll and the project designation symbol were recorded. The principal point, or the point at which the optical axis of the camera hits the photograph, is marked with collimation marks at the sides and top of each photograph. Photo indices at a 1:250,000 scale have been produced from the aerial photographs. These are laydowns of the strips of prints which were allowed to overlap so that the index numbers of each would be visible. The scale at which the laydowns were rephotographed was just large enough to permit the index number to be read.

Controlled mosaics at 1:100,000 and 1:50,000 scales together with their negatives have also been prepared from the aerial photographs. On the mosaics all displacements of points caused by tilt or relief (configuration of the earth's surface) have been corrected or reduced to a minimum. The individual photographs used in compiling the mosaics were of uniform tone and density. The area covered by each photograph used in the mosaic was oriented in the base plot by several well-distributed radial triangulation points.

At present, simple photogrammetric instruments, namely, stereoscopes and to a limited extent parallax bars for height determination, are used in the study of the aerial photographs. These instruments permit a limited use of the aerial photographs, such as for geological interpretation and mineral exploration work, but they cannot

meet the growing need for various kinds of maps required for the intensive development of the country. Certain projects, such as the development of natural resources, construction of highways, airports, etc., cannot be successfully carried out without topographic maps.

To supply the specific projects with the necessary topographic maps, the Ministry of Petroleum and Mineral Resources has planned to establish a photogrammetric section in the Directorate General of Mineral Resources.

The initial functions of the photogrammetric section will be as follows:

1. Planimetric mapping, based on the Shoran-controlled 1:100,000-scale mosaics, which would benefit:
Highway and railway location and planning;
Agricultural and irrigation planning;
The military;
The airlines;
Precise location of concession boundaries;
Precise location of international boundaries.

2. Production of large-scale topographic and geological maps which would facilitate the planning and location of geological, mining, highway, railroad, agricultural and irrigation projects.

The section will include three branches; one branch will be assigned to the production of maps and photographic prints; the second will carry out photogrammetric plotting by Kelsh plotter for the production of topographic maps of limited areas for specific projects, and the third will make the control survey required for the photogrammetric production of topographic maps. An international expert will be assigned to each branch and a programme will be conducted for training the necessary qualified Saudi personnel in photogrammetric work so that they will eventually be able to carry on the mapping programme.

BRIEF REPORT OF CARTOGRAPHIC ACTIVITIES IN SWEDEN¹

The Geographical Survey Office of Sweden concentrates its efforts on two main maps, as follows:

1. An *economic or general land use map* on the scale of 1:10,000, based on a controlled mosaic. The total coverage will include about 11,000 sheets. To date, about 8,000 sheets have been produced;

2. A modern *topographical map* on the scale of 1:50,000, principally produced together with the above-mentioned map and over the same areas.

The Swedish Parliament has recently decided upon a new long-term production programme, covering the next ten years, for the production of official maps. This programme has given the Geographical Survey Office a good basis for the planning of its production and also the necessary financial guarantees.

The Office's actual efforts in Sweden concentrate, among

others, on checking the efficiency of its production by the best work and systematic time studies.

The present policy is to go in for very careful planning of the whole production chain, covering geodesy, photogrammetry and cartography. We have realized that it is not enough to have well-trained technical personnel, but that expert supervisors and administrative personnel are just as necessary.

I think it is typical of Sweden that many governmental organizations working in this field also do much work on order on commercial terms. This is the basis for the Photogrammetric Division of the Geographical Survey Office, which has made it possible for us to organize continuous aerial photography, renewing our photo archives every seven years.

The printing and distribution of the official maps will be taken care of by the Swedish Mapping and Printing Organization, which has recently been organized as a governmental company with map production for different purposes as part of its programme.

¹The original text of this paper, submitted by Sweden, appeared as document E/CONF 36/L 80.

REPORT ON CARTOGRAPHIC ACTIVITIES IN SWITZERLAND¹

In Switzerland, a large part of the official survey programme is performed through private undertakings, except for the establishment of the geodetic control of highest order and the publication of small-scale maps. However, the official organizations, which are responsible for the supervision and entrusted with the checking, take care of the proper co-ordination of the work.

The Swiss Federal Topographic Survey Office falls under the Federal Military Department. It is responsible for:

- (a) National triangulation from first to third order;
- (b) National levelling;
- (c) Publication of topographic maps on the scales of 1:25,000, 1:50,000, 1:100,000 and smaller;
- (d) Checking the general plans at 1:10,000 and 1:5,000 scales, which are prepared photogrammetrically by private geodetic contractors;
- (e) Control surveys on the walls of a number of power dams.

The national triangulation network from first to third order, with a density of one point per 20 square kilometres (8 square miles), was completed about thirty-five years ago. Nevertheless, within the framework of the over-all adjustment of the European triangulation net, new surveys have been undertaken, along the borders, of the first-order net. In order to clear up differences in the closures of the triangulation networks, a check base 7.2 kilometres in length was measured in 1959 near Heerbrugg in the eastern part of Switzerland, by the Swiss Geodetic Commission and corresponding organizations from the Federal Republic of Germany and Austria. As it was not possible to measure the base in one straight line, it had to be laid down in the form of an almost-straight traverse. This base and the extension network are also suitable for the checking of electronic and light-electrical distance measuring equipment.

The national level network was also completed some forty years ago. The work in this field is limited today to systematic revision. In addition, various special levelling surveys were carried out in 1959 and 1960 in subsidence areas. The level network has also been included in the adjustment of the total European levelling system, from which interesting conclusions have been obtained on the determination of 'absolute heights' above mean sea level.

The new topographical maps at the scales 1:25,000 to 1:100,000 are prepared using photogrammetric methods. So that the foundations for the general plans may be laid at the same time, the photogrammetric plotting of central Switzerland and the Jura region is done, in co-operation with the Federal Survey Directorate, directly at 1:5,000 or 1:1,000 scales from photography at the scales of 1:14,000 to 1:25,000. Mapping of mountain areas was done initially at a 1:25,000 scale, but this has been changed to a 1:10,000 scale wherever possible. The photogrammetric plotting at 1:5,000 and 1:10,000 scales is done by private firms, while the Topographic Service takes care of the checking and the cartographic reduction to the smaller scales.

The publication of the general plans mentioned above is therefore preceding the completion of the cadastral survey

in many cases. Originally, it was intended to take the planimetric control for the general plans from the cadastral plans, and merely to complete the contours with special photography.

The general plan has now been published for several years in only one colour. The four-colour plans which were previously issued have been dropped to ease the revision work. The status of published sheets, as expected by the end of 1961, is listed below.

Map scale	Number of sheets published up to the end of 1961	Total number of sheets for all of Switzerland
1:25,000	152	279
1:50,000	75	82
1:100,000	13	22 + 4 half-sheets

In recent years, the extraordinary increase in building and construction activities has forced the Topographic Service to put more staff on to revising the 1:25,000 and 1:50,000-scale maps. Unfortunately, this has slowed down the work on the preparation of the new 1:25,000-scale sheets. Wherever it is advantageous, aerial photographs at the scales of 1:25,000 to 1:30,000 are taken for the revision work. All map sheets at the scales of 1:25,000 to 1:100,000 are prepared in multicolour, with or without shading. Glass scribing is used for all scales.

A whole series of special maps has been prepared for other branches of the Federal Administration, as well as for the public, of which the following deserve mention:

- (a) Maps showing the extension of the areas where chestnut trees grow;
- (b) Maps showing cable communications of the Federal Post, Telegraph and Telephone Administration;
- (c) A map of Mount McKinley, Alaska, for the Museum of Science in Boston, Massachusetts, and the Swiss Alpine Foundation;
- (d) A 1:10,000-scale map of the Aletsch Glacier for glaciological investigation in connexion with the International Geophysical Year;
- (e) Publication of a number of sheets at a 1:50,000 scale overprinted with ski touring information.

The Swiss Federal Directorate of Cadastral Surveys supervises the land registry surveys, works with the Survey Offices of the cantons and commissions the private surveyors to carry out the cadastral work. The private surveyors have, to a large extent, a free hand in the execution of these duties. Scale and accuracy of the maps are laid down, but in general the method of survey is not.

The scales of the cadastral maps depend on land values and lot sizes and lie between 1:5,000 and 1:10,000. The accuracy required is graded according to zones:

Zone	Type of area	Survey method	Mean square position error of boundary marks (centimetres)
I	Cities, large towns	Orthogonal methods	± 1.6
II	Small towns, villages, open cultivated land	Polar co-ordinate methods, photogrammetry	± 5.0
III	Alps and alp foothills	Photogrammetry, compass tacheometry	± 2.0

¹ The original text of this paper, submitted by Switzerland, appeared as document E/CONF.36/L.25.

The cadastral survey is tied to a net of about 75,000 triangulation points of first to fourth order or to about two points per square kilometre.

The cadastral survey has been completed covering over 65 per cent of the area to be surveyed. Compared to the original programme, which provided for the completion of the survey in 1976, the work completed to date is 8.4 per cent behind schedule. However, since the demand for cadastral surveying for purposes of property transfers and building work has risen rapidly during the past few years, it is necessary to look for more rational methods. The wider use of photogrammetry is foreseen for survey zone II, since it is now possible, with careful execution of all the processes and with registration of co-ordinates in the plotting instruments, to obtain mean square positional errors of ± 3.5 cm to ± 5 cm. Several firms make use of electrical co-ordinate printers and card punches connected to their autographs. The transformation of co-ordinates and the adjustment of model fits are left to electronic computers, as in the introduction of ground survey data for filling-in purposes. In addition, the calculation of triangulation stations, traverses, nodal points, compass traverses, detail points and areas from field data derived by classical survey methods is in many cases made with electronic computers. A large part of the checking can thus be included in the electronic processing of the data.

Map revision work presents a big problem due to the shortage of personnel. For this reason, the Survey Directorate is also testing the possibilities of automation of revision, although the prerequisites appear to be rather unfavourable.

The cadastral survey also includes the preparation of the general plans at 1:5,000 and 1:10,000 scales, as described in the section dealing with the Topographic Service. This mapping is completed for about 90 per cent of the area concerned.

The private survey firms, of which ten are equipped with photogrammetric plotting instruments, get their contracts

partly from official and partly from private sources. The most modern methods for highway construction surveys have been developed in Switzerland, by means of which the different variants of a road axis can be computed electronically, using photogrammetrically-measured profile and cross section data. The computer also provides all setting out data.

The Swiss Geodetic Commission is a branch of the Swiss Society for Nature Research. It has concerned itself with the following problems in recent years:

(a) Determination of the geoid in the Bernese Alps (Berner Oberland), making use of vertical angle measurements in the high mountain areas and of several astronomical fixes. On the summit stations, the largest variations in the deviation of the vertical are between 20" and 30";

(b) Gravity surveys with a Worden gravimeter, for determination of the Swiss gravity net (123 stations);

(c) Gravity measurements, using the Worden gravimeter, carried out at 541 stations along the Swiss lines of the European level net and the establishment of connections to stations outside the Swiss borders. A test strip with 549 stations is also being measured in the mountains;

The Swiss Geodetic Commission also took part in the measurement of the Heerbrugg base. In particular, the Commission made the astrofixes of stations of the base extension net, and the gravity measurements at and around the station St. Anto for the determination of the deviation of the vertical.

The future programme of the Commission is the fixing of more Laplace stations, and investigation of the influence of the deviation of the vertical and how it is to be accounted for, continuation of the geoid determinations and the design of the first-order gravity net with approximately one station every 200 square kilometres, with stations placed according to areas, instead of along the lines of the Swiss first-order level net as the original gravity net stations were located.

PROGRESS REPORTS ON CARTOGRAPHIC ACTIVITIES IN THAILAND¹

The cartographic activities in Thailand have been entrusted to the Royal Thai Survey Department since 1883. At first, topographical surveying was done by plane table methods. Maps at the scales of 1:5,000 to 1:50,000 were made covering 42 per cent of the country.

Since 1954, new topographical maps have been compiled by photogrammetric methods. At present, the Royal Thai Survey Department owns one twin-engine aircraft for taking aerial photographs. Two aerial cameras, a Wild RC5 and a Williamson Eagle IX, are available. Almost all of Thailand has been covered by aerial photography at scales between 1:40,000 and 1:60,000. Some specified areas were reflown to obtain aerial photographs at larger scales (1:4,000 to 1:20,000). Most of the photographs taken were intended for topographical map compilation.

After the aerial photography was completed, control for the photogrammetric work and field classification or identification followed. Photogrammetric controls

were obtained by extension from the basic control networks which had already been established (triangulation and traverse stations), and supplementary basic ground controls were planned for those places where the old networks were too far away to provide sufficient accuracy for photogrammetric work. Basic ground control was sometimes used for checking map accuracy.

Problems in accuracy of field work arose when the magnitude of the closing errors exceeded the accuracy specifications of the third order and many places had, therefore, to be resurveyed. On field classification surveys, we annotate on the overlay and on the odd-numbered air photographs only. We survey for the detailed information needed by the map compilers, for example, the classification and identification of cultural, drainage and relief features.

The stereo-compilation of the Survey Department has been done with stereoscopic plotting instruments, including the Wild autograph A6, the Kelsh plotter and the multiplex plotter. Aerotriangulation has been carried out by the United States Army Map Service under an agreement

¹ The original text of this paper, submitted by Thailand, appeared as document E/CONF.36/L.23.

between Thailand and the United States. The United States Army Map Service has assisted the Thais in aerial photography, ground control surveys, aerotriangulation, stereo-compilation and scribing, by distributing responsibility to various areas, in proportion to the number of instruments and personnel available. Thus, the map of Thailand on the scale of 1:50,000 may be printed by the Survey Department in conjunction with the United States Army Map Service, Far East.

The stereo-compilation progressed quite slowly at first, taking the number of instruments into account. With two Wild autographs A6, eight Kelsh plotters and one six-projection multiplex, only about 1.5 sheets were completed in twenty-two seven-hour working days, the size of the sheet from east to west being 15 minutes and from north to south, 10 minutes. This was due to inadequate experience and insufficient personnel. But now, in spite of the similar numbers of instruments and personnel, our stereo-compilation work is satisfactory, producing six sheets a month. This increase was brought about by the growth in the experience of the personnel and the improvement of the administration in this field.

From the beginning of our map making up to the middle of 1957, the pen-and-ink method was used in drafting, but nowadays, plastic scribing on Scriberite orange on Mylar is used instead. At first, scribes with steel points were used but in mid-1960 we adopted scribes with jewelled points. In the same year, we replaced press-proof with rub-on colour proofing, thus saving both time and money.

As regards the present map reproduction in the Royal Thai Survey Department, two process cameras are available, one being a 50" x 50" Hoh-Lux copy camera, the other a 40" x 40" Monotype overhead camera. In addition, four offset printing presses are employed, consisting of two Komori 25" x 33 1/2" single-colour hand-fed machines, one Mann 32" x 49" single-colour automatic machine and one Roland Ultra RVU-V 34 5/8" x 49 5/8" four-colour automatic machine. These instruments are very helpful in reproducing maps of satisfactory quality and accuracy.

In general, we can conclude that the relationships of the various operations at different stages are not altogether satisfactory largely owing to the budgetary problem which limits the numbers of instruments and personnel that may be employed as well as the training of personnel abroad.

The project of producing topographic maps of Thailand on a scale of 1:50,000, consisting of 1,216 sheets, is expected to be completed by 1964. The maps will be bilingual in English and Thai.

The Survey Department is the only place in Thailand where maps are produced. In addition, the following functions are assigned to this Department:

1. Establishment of basic ground control, both horizontal and vertical covering the whole area;
2. Geophysical surveys, as for example, geomagnetic and gravimetric observations;
3. Map making on large scale to meet the requirements of the civilian services;
4. Training of surveyors for both the Army and civilian services.

The Survey Department has set up its own Survey School, which is divided into two sections, one for the

education and training of first-grade surveyors and the other for second-grade surveyors.

In order to fulfil this map making mission, the Royal Thai Survey Department has now been provided with a large budgetary allowance and the necessary personnel. The completed map will be very useful in promoting the development of the country.

The Royal Thai Survey Department is planning in the near future to make maps on a large scale over important areas and to revise maps on the scale of 1:50,000. The techniques of air mapping are rapidly improving. Aerial photographs are the initial source data needed and large funds are required to hire a private company to do this work, to purchase an airplane and to train personnel eventually to operate the craft. Thus, the Department will meet with both high expenditure and the need to train inexperienced personnel.

Cartographic activities in the course of the past three years (1958 to 1961) can be briefly reported as follows.

GEODESY

Triangulation

The first-order triangulation in the eastern area has been extended to provide Cambodia with data for a controlling network. The control survey was also made in the area of the first-order triangulation. This consisted of second-order triangulation and traversing in which the distances were measured electronically by tellurometer and the angles by theodolite. Six new triangulation stations were established with tellurometer trilateration and tellurometer traversing.

Precise levelling

First-order levelling in Thailand has been extended to a distance of 1,753 kilometres and consists of 92 BMP and 1,005 BMS. In 1957, the first-order levelling line of the east of Thailand, about six kilometres in length, was extended in order to provide Cambodia with data for a controlling network.

Geodetic astronomy

The operations in geodetic astronomy in Thailand are directed mainly for the purpose of controlling the triangulation areas and for the determination of the deflection of the vertical; they have not as yet been applied to the detection of crustal movements. This is due to the priority given to the project of map making on the scale of 1:50,000.

Two Laplace stations have been established, one in the north-east and one in the south of Thailand. A plan to establish four other Laplace stations between the end of 1961 and the beginning of 1962 is being contemplated for the southern part of Thailand.

GRAVITY OBSERVATION

Gravity observations in Thailand during the past three years have been accomplished by means of a gravity meter. During this period, Thailand established 410 gravimetric stations. The observations were tied with pendulum stations established on every 100-square kilometre area throughout the country. The computation of free air and Bouguer anomalies has been accomplished at every station, but that of topographical anomalies has not yet been completed. These results have all been sent to the International Union of Geodesy and Geophysics (IUGG).

The gravimetric observations, performed with the aid of a Cambridge pendulum apparatus, resulted in forty-two stations, and the gravimeter is being used to divide these stations into sections.

At the beginning of 1960, the pendulum apparatus was sent from Thailand to the Cambridge Company in England, with the assistance of Professor B. C. Browne, for modification and re-calibration. It is hoped that the work will be finished by the end of the year.

The tie of the gravimetric station at Teddington in England and that at Bangkok will be possible by the end of the year.

GEOMAGNETISM

Magnetic observations have been completed at about seventy-nine stations with the aid of a Dip Circle, an earth inductor, a magnetometer of Indian pattern, a magnetic travel theodolite, a horizontal variometer, a vertical variometer and a variometer of recording camera type.

During the past three years geomagnetic operations in the field have resulted in forty-five stations. The same stations were reoccupied to evaluate the secular variation of magnetic stations.

CO-OPERATION WITH VARIOUS ORGANIZATIONS AND INSTITUTES

Our co-operation with various organizations and institutes during the past three years by furnishing them with data and evaluations of geodetic and geophysical work can be summed up as follows:

1. Delivering data of the first-order precise levelling of Nong Khai Province to the Laotian Survey Department;
2. Co-operating with the United States Army Map Service, Far East, in the measurement of the first-order triangulation in order to evaluate the bench-mark Phnom-ta-Det which lies in Cambodian territory near the Thai border;

3. Co-operating with the United States Army Map Service, Far East, in surveying the first-order levelling to the bench-mark at the bridge across the Khlong Luk at the Thai-Cambodian border for the purpose of making the level network in Cambodia with control data;

4. Exchanging data on map making activities in the Thai-Malay border areas;

5. Co-operating with the Burmese Government in the overflights of Thailand aircraft for the aerial survey;

6. Delivering the principles and lists of instruments of the Royal Thai Survey Department to the Burmese Government for the establishment of the Burmese Survey Department;

7. Delivering to the Burmese Government the aerial photograph positives and negatives of the areas along the Thai-Burmese border from latitude 10° N to latitude 21° N;

8. Lending Thailand aircraft for the purpose of taking aerial photographs of the Mekong Development Project;

9. Delivering to the Mekong Development Authority the evaluation of the bench-marks and the data within the Mekong area from latitude 15° N to latitude 20° N;

10. Exchanging boundary sheets with the Laotian Government;

11. Facilitating flights and oceanographic survey operations by the United States Navy in the area of the Thai Gulf;

12. Making the correct denomination for the Atlas Reproduction Institute of Germany, at its request;

13. Delivering documents relating to the International Map of the World on the Millionth Scale (IMW) to the Geographical Survey Institute of Japan (GSI);

14. Sending annual evaluation reports on geodesy and geophysics to the IUGG.

The Survey Department is now in contact with the GSI for its co-operation in establishing the first-order station of gravity observation in Thailand.

UNITED KINGDOM PROGRESS REPORT¹

Introduction

In the immediate post-war period development programmes for overseas territories served to emphasize the serious inadequacy of topographical map cover and basic field survey data. In 1946, therefore, the United Kingdom Government set up an official department, the Directorate of Colonial (later Overseas) Surveys (DOS), to carry out geodetic survey and topographical mapping in the dependent territories. In 1961, it became part of the newly-formed Department of Technical Co-operation to facilitate the growing volume of work being done in independent territories. By that time, well over three-quarters of a million square miles had been mapped by air survey methods although much work still remained to be accomplished. Current programmes in Asia and the Far East are fully reported in section A below.

Hydrographic surveys are undertaken in far eastern waters by surveying vessels of Her Majesty's Fleet under the direction of the Hydrographer of the Navy. Two

vessels, H.M.S. *Cook* and H.M.S. *Dampier*, were at work in the area during 1959 and 1960 and details of their surveys are given in section B below.

The Royal Air Force have continued to achieve survey air photo cover for various parts of Asia, in projects that had begun at the time of the last Conference. The scale of photography flown in various regions of south-eastern Asia, during the period, is in all cases 1:60,000 with 1:18,000 fan cover.

During the post-war years the increased demand for cartographic products has been felt in the United Kingdom as well as in overseas areas. This demand has increased the production of maps, encouraged discussion on cartographic matters and stimulated the application of new technical developments, both in field survey and cartography. The Ordnance Survey has made important contributions to technical developments which are mentioned in part II of this report. Close collaboration is maintained between Overseas Surveys and the Ordnance Survey and all appropriate developments are adapted for application to overseas mapping and field survey needs.

¹ The original text of this paper, submitted by the United Kingdom, appeared as document E/CONF 36/L 84.

The major part of Overseas Surveys' map production is basic medium-scale mapping at 1:50,000. A standard 1:50,000 sheet usually covers a quarter-degree square (15' latitude by 15' longitude) and shows information about vegetation and land use in addition to relief, drainage and man-made features. In view of the greater speed of production, first editions usually consist of planimetric detail only, supplemented by hill shading where the topography requires graphic representation. If engineering needs are paramount the first edition is contoured; otherwise, revised and contoured second editions are

normally published one to two years after the planimetric edition.

A further aspect of Overseas Surveys' work is the provision of training in new methods and equipment for officers nominated by overseas governments. Surveyors are attached to the Directorate's field survey parties while cartographic draughtsmen and photogrammetrists are attached to the headquarters. Two attachments to headquarters were arranged during 1960-1961 through the Colombo Plan organization.

Part I

A. PROGRESS OF SURVEYING AND MAPPING

British Solomon Islands Protectorate

Sketch-maps at 1:50,000 and 1:40,000 constructed by the Geological Survey Department had been published by Overseas Surveys for Guadalcanal and the Florida Group, respectively, before 1958. Since 1958 similar sketch-maps have been published at 1:50,000 for San Cristoval and Choiseul. Ten contoured sheets at 1:25,000, required for reconnaissance of two new roads across central Guadalcanal, were published in 1960.

Early in 1960 a field survey programme was commenced in the islands, the Overseas Surveys' party of two to three surveyors working in collaboration with the Lands and Mines Department. The programme is designed to supply 1:50,000 mapping control by tellurometer traverse and this has been achieved in Guadalcanal, the Florida group and Russell Islands. Work in the New Georgia group is well advanced, while it is planned that the party should move to Malaita and Santa Ysabel late in 1961 and to the New Hebrides in 1962.

Brunei

Seventeen sheets at 1:50,000 covering Brunei and the adjoining areas of Sarawak have reached an advanced stage of production. Some sheets of the first edition, including those covering the hilly areas of the south, will be contoured.

Fiji

The 1:50,000 series has been published for the main islands of Viti Levu and Vanua Levu together with the smaller islands of Ovalau and Mbengga. The revised and contoured second edition has been completed for Viti Levu and is nearing completion for Vanua Levu, Ovalau and Mbengga.

One-sheet maps are in preparation for Viti Levu and Vanua Levu at a scale of 1:250,000.

One surveyor from the DOS spent five months in Fiji during the first half of 1961, assisting the Department of Lands, Mines and Surveys in the establishment of control for cadastral and road surveys by tellurometer traversing between existing triangulation stations in Viti Levu and Vanua Levu. The tellurometer was also used to establish a connexion between Viti Levu and Vanua Levu and to run a traverse connecting the islands of the Lau group. Lines twenty to sixty miles in length were measured successfully over the sea areas.

Hong Kong

Air photography sorties were flown by the Royal Air Force in March 1959 to cover this area.

The War Office have published two sheets of the 1:10,000 town plan, two sheets in the 1:100,000 series and sheet 614A in the 1:500,000 World Series 1404. The latter sheet was extended south-westwards to include islands located on sheet 614D.

Malaya

Air photo cover was completed by the Royal Air Force during 1959.

Singapore

A four-sheet town plan of Singapore at 1:10,000 was published by the War Office, as a result of joint work with the Chief Surveyor, Singapore.

North Borneo

Air photography sorties have been flown by the Royal Air Force in the north-west sector and along the east coast between Sandakan and Lahad Datu.

Planimetric mapping at 1:50,000 had been published by Overseas Surveys prior to 1958 for fourteen sheets in the Tawau area and fourteen in the Sandakan area. In the latter case a revised edition is currently in preparation. Town plans at 1:5,000 had been published for Jesselton, Sandakan, Kudat and Tawau.

During 1961, thirteen sheets at 1:50,000 covering an area around Lahad Datu were published in provisional form for use by soil surveyors.

A survey party, varying in strength from one to two surveyors, has been working in the territory since 1956. The northern circuit of primary triangulation has been completed by continuing the west coast chain eastwards from Jesselton and southwards from Kudat to Sandakan. From Sandakan a southern chain has been established, running through Lahad Datu to Tawau.

During 1960-1961 the party has been engaged in the establishment of mapping control in an area of some 7,000 square miles of central North Borneo, extending from the Keningau-Sook plains eastwards across mountainous country to the lowlands of the Labuk River. Mapping at 1:50,000 is urgently required as a basis for a large-scale development project in the Labuk valley, which is being partially financed from the Special Fund of the United Nations. Provision of mapping is scheduled for 1962-1963 following completion of new air photo cover during the second quarter of 1962.

Six sheets at 1:50,000 in the Jesselton area were being produced by the War Office in collaboration with the local Survey Department and Overseas Surveys.

Sarawak

Over 20,000 square miles of 1:50,000 planimetric mapping has been published by Overseas Surveys for the western half of Sarawak, recent maps carrying a hill shading plate in order to depict the rugged terrain.

A plan of Kuching at 1:10,000 has been published by the War Office.

Air photo cover has been obtained by the Royal Air Force for parts of the Fourth and Fifth Divisions.

An Overseas Surveys field party commenced work in Sarawak at the beginning of 1960 in order to extend the ground control for medium-scale mapping by means of tellurometer traverses. Coastal traverses were run from Silabu to Rejang in Second Division and from Kuala Igan to Bakenu in Third and Fourth Divisions, line lengths being successfully increased at nearly all stations by the use of a twenty-foot tower made from standard two-inch water pipe.

During 1961 the party has been working in Third Division traversing along the Igan River from its mouth to Sibu and in the Kanowit-Kapit area near the southern limit of the Division.

In this wet and heavily forested country, the reduction in the amount of observing and clearing required for tellurometer work as compared with triangulation has contributed to a considerable acceleration in the establishment of ground control. The major drawback consists of the heavier loads of equipment which must be carried by porters or crammed into small unstable canoes for transport into the remoter areas.

Thailand

The 1:63,360 series covering the Kra Isthmus has been published by the War Office with revised communications.

B. HYDROGRAPHY

H.M.S. Cook carried out surveys off the British Solomon Islands Protectorate, Fiji and the Gilbert and Ellice Islands during 1959. H.M.S. Dampier was at work in far eastern waters during 1959 and 1960, carrying out surveys off Malaya, Sarawak, North Borneo and Hong Kong.

H.M.S. Cook

On arrival in the Solomon Islands in December 1958, two reconnaissance surveys were put in hand at Bina Harbour and Fiu Bay in Malaita Island. Bina Harbour, which had never been surveyed before, proved to be so promising after a quick reconnaissance, that it was decided to carry out a full survey. A survey party was therefore established in the Catholic Mission at Buma, and from this base surveyed the whole of Bina Harbour on a large scale, completing the work in late February 1959. The ship visited this party at intervals of about three weeks to replenish stores and provisions, and spent the greater part of the remaining time in proceeding to and from Port Moresby, about 1,000 miles away, to embark fuel. Whilst on passage to and from Port Moresby, continuous soundings were obtained; care was taken not to traverse the same track twice, so that quite a large area of the Coral Sea has now been delineated. On New Year's Day, 1959, a new bank was discovered south of the island of Guadalcanal; this bank was surveyed during the next fortnight.

The detached parties were re-embarked towards the end of February and the ship then proceeded to Port Moresby for fuel before sailing for Sydney.

After delays due to repairs the ship sailed for Fiji on 7 May to undertake a survey of the approaches to Lambasa. A certain amount of time was saved on this survey by flying up a small detached party who were able to get well ahead with the triangulation before the ship arrived.

On passage from Auckland to Fiji one seamount was investigated and one oceanographical station occupied.

While the detached party was progressing with the Sambasa survey, the ship was able to complete a survey of Vuya Passage at the southern end of Vanua Levu.

At the end of June both the Lambasa and Vuya Passage surveys had been completed and the ship moved to Ovalau where a survey was required from the northern part of Ovalau to Viti Levu.

In mid-August the ship sailed for the Gilbert Islands to undertake the survey of Betio Anchorage at Tarawa. A small advance party were kindly flown up by the RNZAF, Lauthala Bay, and this enabled the triangulation for the survey to be completed before the ship's arrival.

On leaving Tarawa the ship proceeded to Nikunau and carried out a rapid survey of the island in three days. Nikunau is an exposed reef island with no lagoon and the ship had to anchor in deep water uncomfortably close to the reefs.

The next two months were spent completing surveys of Abemama in the Gilbert Islands and Nanumanga in the Ellice Islands.

During the passages between Suva and the Gilbert Islands continuous passage soundings were carried out over well-dispersed tracks, and searches were made for Grand Cocal Shoal, Eagleston Reef and a reported five-fathom shoal, none of which was found and which probably do not exist. A running survey of Nui Island was also carried out.

In mid-November the Abemama survey was completed and the ship commenced the long journey to Singapore via the Solomons and Port Moresby.

H.M.S. Dampier

H.M.S. Dampier sailed from Singapore on 19 January 1959, to continue the surveys on the west coast of Malaya between Penang and Lumut, started the previous year. These consisted mainly of the very shallow and muddy waters off the entrance to Port Weld; the boats had to negotiate over twelve miles with less than ten feet of water, which caused very heavy wear on their propeller shafts, of which each boat wore out at least one during the four weeks in the area.

A short visit was then made to Hong Kong where the various harbour charts were brought up to date for the extensive reclamation and rebuilding work taking place in the harbour.

After a self-refit in Singapore, the first major surveys were put in hand on the east coast of Malaya. These included two naval exercise areas south-east of Palau Aur, one of which had been sounded in 1958 but had not been swept for obstructions. Both these areas were covered, using two-range Decca.

Two further surveys were then carried out in the area between Kuantan and the entrance to Kuala Pahang.

At the beginning of September the ship sailed for Sarawak where a survey of the coast between Tanjong Sirik and Mukah was carried out. This coast is very flat.

with mangrove, sago and casuarina trees stretching some sixty miles inland. The local Lands and Surveys Department has re-covered several traverse points along this coast and the survey was carried out in conjunction with the Sarawak Hydrographic Survey Unit, under Captain C. C. Lowry, R.N. (Retd.).

During November the ship returned to the west coast of Malaya to finish the survey of the approaches to the Dindings River and start the sounding of the western approaches to the South Channel to Penang.

In early 1960 a survey was made of the entrance to Johore Straits, during which time the ship remained in Singapore so that new radar equipment designed for surveying could be fitted.

Three simultaneous surveys on different scales off Port Dickson were the next main task; all were designed to assess the possibilities of the port for major commercial development.

In May, the Dampier sailed for the east coast of Borneo where two surveys were carried out to provide a surveyed channel into Kunak, the new port for the Mostyn area. This somewhat remote bay had not been surveyed since 1891-1892 and several coral reefs had since been reported in approximate positions.

Surveys in Malaya occupied the next three months. One party was detached to survey the entrance to the West Johore Strait and to continue the survey of the approaches to Singapore Island, including all the islands on the west side of Singapore.

The ship was engaged on a major survey of the east coast of Malaya from Tanjong to Dungun, an area of approximately 2,200 square miles. Except for inshore boat work, the survey was controlled entirely by the two-range Decca system, a saving of at least 50 per cent in time on the old method of floating beacons.

The ship sailed for Hong Kong on 31 October, proceeding westward of the Paracel Islands; this route was selected to enable deep soundings to be obtained in the more sparsely charted areas and to delineate the 100-fathom line south of Hainan. Special water samples, required by the National Institute of Oceanography from depths of 500 fathoms and 1,400 fathoms, were also obtained.

During the three-week stay at Hong Kong, numerous small areas were sounded in the vicinity of the piers and wharves where development and reclamation had taken place.

On the return to Singapore more passage sounding was obtained and a dangerous shoal in the Carimata Strait, reported on a few days previously by H.M.S. Carysfort, was surveyed.

C. AIR CHARTS

The Asian and far eastern area is covered by the Royal Air Force 1:1,000,000 topographic series GSGS 4695. In addition the plotting and planning series at 1:3,000,000 and 1:6,000,000 provide cover.

The 1:500,000 series GSGS 4715 covers Cambodia, Laos, Malaya, Thailand, Viet-Nam and a large part of Burma.

Of the ICAO 1:1,000,000 series for which the United Kingdom is responsible, chart numbers 2857-2861 have been published. Production is in progress for charts 2614, 2804, 2916, 3037, 3118, 3212, 3240 and 3241.

D. SPECIALIST (TOPICAL) MAPS

There has been a growing demand for land use, forestry, geological and soil mapping. Wherever possible the 1:50,000 series is used as the base map for portrayal of specialist information and in some cases, as for example in the Lahad Datu area of North Borneo, outline editions have been specially provided for use by soil surveyors.

Specialist investigation is undertaken by officers of the Forestry and Land Use Section of Overseas Surveys whose work is based on aerial photo-interpretation supplemented by field studies in the territories concerned.

Areas of South East Asia where work has been carried out include underpopulated areas. For example, the population density of North Borneo and Sarawak is estimated as only fourteen persons per square mile. Thus, the natural forest vegetation over large parts of these territories has been little altered by man. The assessment of the forestry and development potential of these undisturbed areas is often difficult on the ground because the local road systems are only partly developed. However, forest-type mapping, using aerial photographs and based on the minimum of ground control, enables a relatively quick preliminary appraisal of these forests to be made. One project of the Section has been forest-type mapping of some 7,000 square miles for the Sarawak Forest Department.

Geological and soil maps are prepared for printing from draft material supplied by geological survey departments and soil surveyors. In many cases the complex information requires a graded colour system for successful cartographic representation. To achieve this, a three-colour process has been used in which the three primary colours, yellow, red and blue, are each represented by a solid colour, a single line ruling and a cross line ruling. Combinations of the solids and ruling provide up to sixty-three shades of colour. The prime object of speed in map production does not always allow for this degree of elaboration. Two basic colours, yellow and blue, have therefore been used to depict land use and vegetation categories in a coastal marshland area scheduled for rice development, extra subdivisions being provided where necessary by adding a coarse stipple to the grey land use boundary line plate. In other cases ten categories have been successfully represented by varied line rulings and zipatones printed in one colour.

For the British Solomon Islands Protectorate a number of geological maps have been published at scales varying between 1:150,000 and 1:250,000, illustrating the investigation of mineral resources carried out by the Geological Survey Department. Fully coloured maps have been prepared for the eastern part of San Cristoval, western Guadalcanal and north and central Guadalcanal, together with black and white maps of Choiseul and larger-scale maps of the Betilonga Basin in Guadalcanal.

The first sheet of a fully coloured geological series at 1:50,000 has been published for the Suva area of Viti Levu in Fiji.

A three-sheet outline map at 1:500,000 covering Sarawak, Brunei and North Borneo has been published for geological use. A map illustrating the distribution of materials suitable for road building in the same area is in preparation at 1:1,000,000.

Eight fully coloured soil maps at 1:50,000, covering the Semporna Peninsula area of North Borneo, have been

published to illustrate a soil survey report in connexion with an agricultural development scheme.

Twenty-four outline maps and three fully coloured maps were produced from draft material provided by the Department of Lands, Mines and Surveys for the report of the

Burns Commission on Fiji. Varied information concerning the relief, climate and economy was depicted on the maps in order to illustrate the geographical background to land and population problems in the territory.

Part II. Review of technical developments

FIELD SURVEY

Tellurometer

The most important development has been the introduction of the tellurometer, a microwave distance measuring instrument which has been revolutionary in speeding up field survey and in minimizing delays due to poor visibility (1).² The instrument is currently in use by Overseas Surveys in establishing ground control for 1:50,000 mapping in the densely forested areas of North Borneo, Sarawak (2) and the British Solomon Islands Protectorate. It is also being used extensively for topographic and geodetic surveys in Africa (3) and for large-scale and cadastral surveys in the West Indies.

The tellurometer has been used by the Ordnance Survey for checking the scale of the primary retriangulation of Great Britain (4). It is also being used extensively for the measurement of distances in the fixing of secondary and lower-order control.

Use of the tellurometer for hydrographic purposes is described in the section on hydrography at the end of this report.

Air-borne profile recorder

The air-borne profile recorder, which records the ground profile along the flight lines of the survey aircraft, has been investigated with regard to possible economies in the amount of field survey data required for contouring (5). It has proved possible to obtain height information of sufficient accuracy for contouring at an interval of fifty feet, provided one point is heighted on the ground in order to establish a connexion with sea level. Although experiments so far have not indicated an economy when compared with height control positioned on the ground, it is anticipated that circumstances may arise when use of the air-borne profile recorder would prove advantageous, and an instruction manual has been prepared.

Gravity measurements

The Ordnance Survey is investigating the possibility of determining by field observations the actual values of gravity along geodetic level lines in order to recompute the geodetic levelling net for scientific purposes in terms of geopotential units.

COMPUTING

The main development has been the introduction of electronic methods.

Overseas Surveys has had access to a Ferranti Pegasus Mark I electronic computer for about eighteen months. During this period an increasing number of survey computations have been analysed and programmes produced for use on the computer. This has involved a

² Figures in parentheses refer to the numbered entries in the bibliography at the end of this report.

change in approach so that the preliminary work produces data which is suitable for assimilation by the machine.

The greatest saving of time in the computing section has been in the adjustment of triangulation. A system has been developed using the variation of co-ordinates technique in which provisional co-ordinates and observed angles, lengths and azimuths are fed into the computer and, after several successive machine processes, the final adjusted co-ordinates and the corrections to the observed quantities are printed out. At present, with the equipment available, the size of the adjustments which can be undertaken in one piece is limited. An adjustment with forty-two new points in a framework of fixed points with 300 observed quantities can be completed in about three and a half hours of machine time.

Other survey computations for which programmes have been developed include the solution of condition equations, the conversion of co-ordinates between geographical and grid values, the computation of long lines, traverses on the spheroid and photogrammetric block adjustment.

Programmes to convert other computations from hand to electronic methods are being developed continuously and existing programmes are being improved to widen their scope.

The Ordnance Survey is continuing to carry out research into electronic computing for analytical aerial triangulation and a programme is being devised to carry out the block adjustment on a digital computer.

AERIAL PHOTOGRAPHY

Improved cameras, together with high-resolution film, have led to a reduction in the contact scale required for 1:50,000 mapping.

The new Wild super-wide-angle camera was used for aerial photography flown in British Guiana in 1960 and in the Bechuanaland Protectorate in 1961. This camera is being closely studied since it offers the advantage that each exposure covers an area three times larger than that covered by cameras hitherto used. The advantage is, however, offset by some loss of ground resolution.

Experiments have been carried out in Uganda in order to assess the relative value of panchromatic and infra-red photography in specialist interpretation of crops and forest types.

The Ordnance Survey have investigated the accuracy achieved from infra-red photography in the survey of tide lines. Results indicate that the accuracy is sufficient for 1:1,250 and 1:2,500 plans.

MAP PRODUCTION

The Directorate of Overseas Surveys carry out fair drawing by "inking up" the original planimetric plots, from which two negatives are then made, the blue and black detail being separated by duffing. Plastic drawing

media are widely employed together with scribing which, with the aid of the neg-proof-etch process, is being successfully applied to name and ornament as well as to line detail.

Ordnance Survey experiments with the scribing method include direct scribing of contours at six-inch scale in stereoplotting machines. A specially prepared Astrascribe material is used to provide an acceptable negative for plate making.

Development tests continued with an automatic reading planimeter for the measurement of areas on the 1:2,500 series published by the Ordnance Survey.

Testing of textile fibre and plastic laminated printing papers continued.

Map production at two scales from one original

Increasing demand is being felt in the smaller islands for a map series at 1:25,000 paralleled by a larger-scale series covering urban and any other areas scheduled for development. To meet this need in the case of Cyprus, Trinidad and Tobago, a method has been evolved and put into production whereby printed stocks at 1:10,000 and 1:25,000 can be prepared from one basic set of originals scribed on Astrafoil at 1:10,000 (6).

Joint specification for production of 1:500,000 and 1:1,000,000 land maps and aeronautical charts

To achieve economies in production of the maps and air charts at 1:500,000 and 1:1,000,000 scales, a technique has been developed by the War Office for compiling at 1:500,000 scale initially, and using this as a basis for all further productions. The method requires full co-ordination of specifications for the different series and the War Office has published a 'Joint Specification' covering series 1301 (1:1,000,000 Land Map), 1404 (1:500,000 Land Map), GSGS 4695 (1:1,000,000 Air Chart) and GSGS 4715 (1:500,000 Air Chart), the adoption of which makes the technique feasible. Current production of the land series 1301 and 1404 is based on this specification and sheets in the aeronautical charts series have been produced experimentally. With closer agreement between the specifications of the IMW series at 1:1,000,000 scale, and the ICAO 1:1,000,000 charts, this technique could be used to produce both styles from a common compilation.

Two-projector bridging with multiplex and inclinometer

In under-developed areas speedy provision of relief information as a supplement to the planimetric detail is often vitally important. It has therefore been the subject of experiment by Overseas Surveys. A relatively small improvement to the Williamson multiplex equipment, the inclinometer, has made it possible to adjust long bridges using two projectors (7) and has greatly increased the rate of height adjustment and contour plotting. A streamlined method of contouring based on the concentration of height control around the perimeter of large blocks of photography, with a minimum of height control inside is also used.

Hill shading

Even streamlined methods of contouring, however, require considerably more time than planimetric mapping. A method of hill shading has therefore been introduced in order to provide interim relief information on first editions covering hilly areas, such as Sarawak or the volcanic crater country of the Southern Cameroons. These first editions are later followed by contoured and revised

second editions. Hill shading an average 1:50,000 sheet takes some three cartographic draughtsman-weeks. It is carried out by viewing a stereoscopic model superimposed on a ferro-prussiate blue impression of the planimetric plot prepared from the same air photographs. An instrument, the Stereo-sketch, has been devised for this purpose and a short monograph describing the technique is in course of preparation. Pencil shading to represent the topography is carried out directly on the ferro-prussiate blue impression which is prepared on stable plastic material suitable for direct reproduction through a half-tone screen.

An alternative technique has been evolved by the War Office. A three-dimensional model of the terrain is produced by hand-moulding a plastic sheet and using this as a basis for producing hill shading on the finished product. The plastic model is illuminated from the north-west and photographed. The result is produced for printing as a half-tone. The method is rapid and economical and is particularly useful where relief data are insufficient to permit conventional methods being used.

Analytical aerial triangulation

The Ordnance Survey method of analytical aerial triangulation has been further developed (8). Automation in computing now makes it possible to complete the computations of a block of 100 stereograms in about four machine-hours on the Deuce electronic computer, the work being done in three separate stages.

In the first stage, the x and y readings made in the stereocomparators are corrected for the earth's curvature, atmospheric refraction, camera calibration and reseau calibration.

In the second stage, the stereograms are solved and the x and y co-ordinates of the points along each strip of stereograms are calculated in arbitrary strip co-ordinates.

In the third stage, these co-ordinates are transformed into block co-ordinates, the block being at approximately the correct scale but having an arbitrary orientation. (The three stages, which take about four hours on Deuce, would take about 500 man-days using desk calculators.)

In the fourth stage, using the Jerie analogue computer, the national grid co-ordinates are obtained by the adjustment of the block co-ordinates to the ground control.

The observations of points in the stereocomparator were formerly being made relative to the reseau system of the photographs. These observations are now being made relative to the base line with the photographs set in correspondence, which is much more satisfactory for the observer. This change has been made economically feasible by the use of punched-card computing to transform or rotate the stereocomparator observations from the base line system to the reseau system.

Trials with the prototype of the Hilger and Watts recording stereocomparator were completed on behalf of the War Office, by whom a report is being published.

HYDROGRAPHY

The increasing use of electronic aids in surveying work is enabling a high standard of accuracy to be achieved in areas where precise control of position would have been impossible by purely visual methods; in addition, the time absorbed by the use of electronic instruments for a given task is considerably less than would be needed were visual methods alone employed.

All surveying vessels of Her Majesty's Fleet operating overseas are equipped with a tellurometer distance measuring outfit. A marine version of the tellurometer, the hydrodist, has also proved accurate and adaptable during sea trials. The hydrodist enables a vessel's position to be fixed very accurately to distances of up to about twenty sea miles from the shore by simultaneous measurement of two ship-to-shore distances.

Two-range Decca is used extensively. A recent improvement to this is the Lambda system which provides land identification.

A short-range Decca system known as Hi-Fix has so far not been used by the Hydrographer of the Navy. It gives a more accurate fix and is much more portable.

Precision echo sounders are being developed by the National Institute of Oceanography for deep sea sounding and will eventually be used in the waters of the Far East.

BIBLIOGRAPHY

- (1) "First-order traversing with the tellurometer", *Empire Survey Review*, vol. XIV, No. 109, July 1958.
- (2) "An inexpensive tower for tellurometer traverses", *Empire Survey Review*, vol. XVI, No. 121, July 1961.

- (3) "Field surveys with the tellurometer", Paper No. 28, *Report of Proceedings, Conference of Commonwealth Survey Officers, 1959*.
- (4) "Use of the tellurometer by the Ordnance Survey", Paper No. 26, *Report of Proceedings, Conference of Commonwealth Survey Officers, 1959*; "The tellurometer", *Chartered Surveyor*, vol. 92, August 1959, and *Ordnance Survey Technical Paper No. 10*, April 1961.
- (5) "The use of the air-borne profile recorder and associated equipment for photogrammetric mapping", *Chartered Surveyor*, vol. 93, July 1960.
- (6) "The production of six inches to one mile and 1:25,000 mapping from one fair drawing", Paper No. 20, *Report of Proceedings, Conference of Commonwealth Survey Officers, 1959*; "Contemporary cartography", *Cartography*, forthcoming vol. IV.
- (7) "Multiplex with two projectors and inclinometer", *Photogrammetric Record*, vol. III, No. 15, April 1960.
- (8) "Analytical aerial triangulation in practice", Paper No. 5, *Report of Proceedings, Conference of Commonwealth Survey Officers, 1959*; "The resurvey of the six-inch maps of Scotland", *Photogrammetric Record*, vol. III, No. 16, August 1960; "Recent developments in analytical aerial triangulation at the Ordnance Survey", *Photogrammetric Record*, vol. III, No. 14, October 1959.

PROGRESS REPORT OF CARTOGRAPHIC ACTIVITIES BY THE UNITED STATES OF AMERICA, OCTOBER 1958 TO OCTOBER 1961¹

GEODESY

During the reporting period, the extension of triangulation and level networks was continued in the United States. Permanent geodetic marks were established pursuant to a programme planned for immediate and long-range topographic mapping and engineering projects. In addition to the control established for regular surveying operations in the United States, control was also established specifically for highway construction, military projects, water resources and development, aeronautical aids, positioning and testing of modern weapons for the Department of Defense and for outer space guidance.

In conformance with long-established policy, the geodetic programme of the United States is geared to long-range as well as immediate special requirements wherever practical. Permanent monuments are established on most surveys and geodetic data are made available.

An example of international co-operation in surveying is the Blue Nile River Basin Geodetic Control Project undertaken by the Ethiopia-United States Cooperative Program for the Study of Water Resources of the Blue Nile River Basin in Ethiopia. Geodetic surveys were required for controlled aerial mosaic mapping and with a view to providing the basic surveys for future topographic mapping in the basin, and also to provide an initial geodetic net suitable for expansion throughout the remainder of Ethiopia. A further requirement of the project was to give on-the-job training to Ethiopian engineers and assistants in geodetic methods and procedures.

The specifications called for first-order horizontal and vertical control stations covering an area of approximately 120,000 square miles in the remote highlands of north-central Ethiopia where elevations ranged from 2,500 feet

at the Sudan border to 15,000 feet north of Lake Tana. The terrain in this area is extremely mountainous where the high plateau area is cut by the tremendous canyons of the Blue Nile River and its tributaries. Very few roads suitable for vehicles exist, and much of the transportation of survey parties was accomplished by helicopters.

The surveys were started in the fall of 1957 and were completed in November 1960. Twelve United States Coast and Geodetic Survey technicians supervised the operations and accomplished much of the actual field work along with the training of Ethiopian personnel assigned by the Imperial Ethiopian Government, Ministry of Public Works, Water Resources Department. A maximum of sixty Ethiopian engineers, assistants and supporting personnel were assigned. The organization consisted primarily of a triangulation party and a levelling party. Small sub-parties completed astronomic observations, base line measurements, air photo identification, etc., as required.

Both the triangulation and levelling were connected to first-order surveys in the Sudan. This was accomplished by the mutual consent of the two Governments, and the survey parties crossed the border, made the connexions and carried the surveys into Ethiopia and the Blue Nile River Basin. The connexions provided a mean sea level datum based on the Mediterranean Sea at Alexandria, Egypt, for the vertical control established by the project, and a geographic datum based on the African 30th meridian arc of triangulation (African datum) for the horizontal control.

The triangulation is also connected to existing triangulation in Eritrea and in south-east Ethiopia, thereby providing data for recomputing these schemes on the African datum and further extending geodetic control in Ethiopia.

The levelling survey was continued from the Blue Nile River Basin eastward to Asseb, Ethiopia, on the Red Sea,

¹ The original text of this paper, submitted by the United States of America, appeared as document E/CONF.36/L.29.

thereby providing a valuable line of bench-marks through the northern Awash River valley and a tie to mean sea level of the Red Sea.

Continuous latitude observations at Gaithersburg, Maryland, and Ukiah, California, were maintained by the United States Coast and Geodetic Survey in co-operation with the International Latitude Service. A programme was maintained for continuous observations with the Markowitz dual-rate moon camera and the Danjon impersonal astrolabe at the special IGY station near Honolulu, Hawaii. Astronomic observations to determine the deflection of the vertical along the transcontinental geoid profile, 35th parallel, were completed. A total of thirty-two first-order and 154 second-order astronomic positions were determined on this project. Ten astronomic positions and six azimuths were observed in Ethiopia for control of the Blue Nile triangulation project. A total of ninety-two astronomic positions and sixty-one azimuths were observed in the United States and other areas in connexion with control of triangulation, earthquake studies and various national defence projects.

New equipment was adopted for recording first-order astronomic longitude observations, resulting in improved performance and substantial weight reduction.

In co-operation with the United States Antarctic IGY programme, the position of the South Pole station was computed from a series of star observations taken during the period May-September 1958.

Assistance was rendered various military agencies in providing deflection of the vertical data at several rocket launching and observing facilities.

Many of the triangulation parties of the Coast and Geodetic Survey have been equipped with a tellurometer so that triangulation, trilateration or traverse may be observed with the specifications of each individual project determining the type of equipment and techniques to be employed. Special methods of adjusting combinations of triangulation and trilateration were developed wherein appropriate weights were assigned each type of measurement. This type of combination adjustment is especially useful in processing geodetic observations taken along the interstate highways.

Because of the availability of this high-speed calculator, assistance was given to a study in the application of three-dimensional techniques for the adjustment of triangulation and trilateration in space. The experience gained in the development of mathematical procedures and programmes for this three-dimensional method of adjustment has been helpful in the development of programmes for the analytical treatment of aerotriangulation.

Special emphasis has been placed on the correlation of geodetic positions between widely separated points, including intercontinental distances. This work makes full use of gravity data together with triangulation and trilateration surveys accomplished through the years to establish an improvement in the size and shape of the earth and to relate preferred data to an earth-centred system.

GRAVIMETRY

The United States Navy Hydrographic Office has successfully employed La Coste and Romberg gravity meters aboard submarines and surface ships. A concerted programme to collect ocean gravity observations has been under way since May 1960 to provide data for use in vari-

ous geodetic, navigational and oceanographic programmes. Computation of the deflection of the vertical by astro-gravimetric methods has been accomplished at several isolated islands. The ultimate goal is a general gravity survey of all ocean areas. Current development activity on an air-borne gravity meter will probably make this an important reconnaissance instrument within the next year or two. Other types of sea gravity meters are also being tested and evaluated as they become available.

The United States Coast and Geodetic Survey completed area gravity surveys covering about 150,000 square kilometres in Minnesota and North Dakota at a station spacing of approximately ten kilometres. This area was developed to extend the gravity coverage northward for determination of a geoid profile between Texas and the Canadian boundary.

Gravity meter base traverses were completed between Washington, D.C., and Key West, Florida, and between Bellingham, Washington, and San Diego, California. The west coast base traverse was connected to the mid-continent traverse by direct air transport over three lines. A new gravity meter calibration base was established at Sperryville, Virginia, consisting of two stations having a gravity difference of about seventy-four milligals. This base provides more reliable calibration than the longer base previously employed.

A gravity traverse, consisting of measurements at 351 bench-marks, was completed on the primary line of levels between Dallas, Texas, and Los Angeles, California. A similar gravity traverse between San Francisco and Kansas City, Missouri, was in progress. These surveys were executed to provide an extension of the gravity base system, and to determine gravity on bench-marks at appropriate spacing for precise level reductions. The average station spacing was five miles with intermediate stations in cases of large elevation differences.

GEOMAGNETISM

This regular five-year series of isogonic charts of the world is continued with a new issue which was published at the beginning of 1960 by the Navy Hydrographic Office. This chart, together with accompanying smaller charts covering the polar regions, was compiled by the United States Coast and Geodetic Survey. For the first time, the lines have been compared and co-ordinated with those of the corresponding chart compiled by the Astronomer Royal of Great Britain. The United States Coast and Geodetic Survey also published the isogonic chart of the United States which included the states of Alaska and Hawaii for the same epoch. These charts show, as usual, the distribution of magnetic declination and of its annual change, and the locations of magnetic observatories. Another chart was prepared to show the magnetic declination in the Great Lakes area; this was printed and is distributed by the United States Lake Survey. Finally, a set of 1:5,000,000 charts, one encompassing Mexico, Central America and the West Indies, and the other two together covering South America, are being published by the Army Map Service.

The new charts reflect substantial improvements in the data in some areas, such as the North Atlantic Ocean, and marked changes in the isopic patterns in other areas, such as the Caribbean and the South Atlantic. The region of eastward change centred over the Mediterranean has expanded to include much of the South Atlantic. At the same time, the South American focus of westward change,

though retreating from the Atlantic, seems to have intensified somewhat in the Brazil-Peru region, and it has spread to the north so as to increase the change rates substantially as far north as the Gulf of Mexico.

The Navy Hydrographic Office has begun a new aeromagnetic survey using the Naval Ordnance Laboratory vector air-borne magnetometer. This survey will eventually cover much of the water area of the globe and should contribute importantly to the accuracy of the 1965 world chart programmes.

Another step forward in magnetic survey work is the use of portable recording instruments to improve the reduction to epoch of repeat observations on land.

The expanded operations of the International Geophysical Year were carried out as planned and the resulting data are still flowing to the World Data Centres as the reduction and processing are accomplished. The United States programme included an important group of stations operated by the Scripps Institution of Oceanography in the Line Islands of Polynesia.

The station at Guam has been continued by the United States Coast and Geodetic Survey as an addition to its network of permanent observatories. Magnetic work at Byrd Station and the South Pole (Amundsen-Scott) Station is likewise being continued under the United States Antarctic research programme. Wilkes Station has been turned over to New Zealand agencies. The rapid-run equipment at Fredericksburg, Tucson, Honolulu, Sitka, College and Barrow is being continued in operation.

Instrumental advances reported include a variable-area magnetograph recorder using 70-mm film, a proton vector magnetometer capable of great accuracy, another proton-precession instrument for following changes in dip and declination, a towed-fish magnetometer for the study of off-shore magnetic field patterns and an alkali-vapour magnetometer which is proving suitable for space exploration in regions of very weak field.

Institutions that have contributed to observational geomagnetism, besides those already mentioned, include the Carnegie Institution of Washington, the US National Bureau of Standards, the US Air Force Cambridge Research Center, the US Army Signal Research and Development Laboratory, the US Geological Survey and the High Altitude Observatory of the University of Colorado. Research activities have been conducted by some of these agencies and also by the California Institute of Technology, the University of Alaska, the Applied Physics Laboratory of Johns Hopkins University, the Naval Ordnance Laboratory, the Naval Research Laboratory, the National Aeronautics and Space Administration and the University of Maryland.

The acquisition of new world-wide data in the United States by correspondence and exchange is currently beginning a buildup looking toward the planned work on the 1965 magnetic charts. A new tabulation form has received international approval for disseminating these results, with a good prospect for stimulating their collection and exchange through an international committee on world magnetic survey. Data already received include a large volume of results from the operation of vector air-borne magnetometers in the Navy Hydrographic Office project Magnet. Preliminary studies are well advanced as analytical techniques for improving the charts.

One of the sub-centres of World Data Centre A, operated by the United States Coast and Geodetic Survey

for the collection and exchange of data in geomagnetism, seismology and gravity, has continued to function. The office processing of IGY and IGC-59 (International Geophysical Co-operation, 1959) results from magnetic observatories is also continuing. Most of the IGY data from observatories operated by the Bureau have either been distributed or printed, ready for distribution shortly.

As part of the United States co-operation with the International Association of Geomagnetism and Aeronomy, magnetic activity from all of the United States Coast and Geodetic Survey observatories were prepared and forwarded to the international centre in the Netherlands. This work included a substantial effort devoted to examination of magnetograms for selected magnetic effects.

SEISMOLOGY

The temporary stations established by the United States Coast and Geodetic Survey as part of the IGY seismology programme have continued in operation. These stations (South Pole, Byrd, Koror, Guam, Iruk, Kipapa and Thule) have contributed a vast storehouse of basic seismic information. The data from the thousands of seismograms, analysed to date, have furnished a more complete understanding of the local seismicity in the western Pacific, the Antarctic and the Arctic regions. Also, the distribution of the stations has provided strategic geographic coverage and aided immeasurably in the Coast and Geodetic Survey international epicentre programme. Approximately 1,300 earthquakes with magnitudes greater than $5\frac{1}{2}$ were located annually during the past two years.

Some results from the preliminary analysis of the IGY data were:

(1) The Antarctic continent seismicity consists of infrequent weak shocks and appears to be associated with the Ross Sea embayment. No major shocks occurred on the continent during the interim;

(2) Microseismic results of the western Pacific stations tend to support the claim that the "Andesite line" is contiguous with the lineation of the Mariana Islands. Less definite is the easterly extension in the Caroline Islands;

(3) The short-period vertical seismometers operated at the western Pacific stations were extremely efficient in detecting the water-borne T-wave, a highly diagnostic phase associated with shallow submarine earthquakes.

In south-east Alaska on 9 July 1958, there occurred a spectacular and devastating earthquake of magnitude 8 centred near Lituya Bay. The bay, a restricted fiord, witnessed a mammoth denudation of tree growth along its shores. The upper limit of the denudation was 1,800 feet on a steep-angled spur. Some authorities viewed this as the maximum height of the rampant water wave that dashed to pieces one fishing vessel, killing its two occupants, and threw another (forty feet long) over La Chaussee Spit into the Pacific Ocean. Because of the intense interest in the effects of this earthquake, the United States Coast and Geodetic Survey launched an extensive field survey programme involving aerial photography, hydrography and tide measurements. It is also anticipated that geodetic measurements will be projected for this dynamic area in the very near future.

Using seismic reflection methods Lamont Geological Observatory and Scripps Institution of Oceanography have conducted surveys in the Atlantic about 200 miles

north of Puerto Rico and in the Pacific under the Albatross Plateau and 2,000 miles south of San Diego to obtain data on the most feasible location for drilling a hole through the crust of the Moho. Many problems, such as those connected with designing and developing core drilling equipment which could withstand the temperature and chemical actions expected at great depths, and the decision as to whether the mechanical drive drilling should be placed on a platform on the water surface or on the ocean floor, must be resolved before actual operations can be started.

TOPOGRAPHIC MAPS AND AEROPHOTOGRAMMETRY

Photogrammetric cadastral surveys were also accomplished during the reporting period, including coverage of two townships of ± 94 square kilometres on which first-order stereoplotting equipment was used with the application of mathematical solutions of aerotriangulation bridges. For this purpose, an intensive search was made and all existing and/or recognized land monuments were identified by photo field inspection. In cases of insufficient geodetic control for aerotriangulation purposes, additional stations were established to fulfil requirements. The resulting plate is used to determine, on the basis of record notes and application of standard measurement principles, the location of missing or undetermined monuments. Here again, photo image or reference points were selected for transfer of established positions to the ground.

During the reporting period, the Geological Survey, United States Department of the Interior, published over 3,900 new topographic maps in the 7½- and 15-minute series covering nearly 969,000 square kilometres. This progress included mapping in each of the fifty states, the District of Columbia, Puerto Rico and the Virgin Islands. More than 22,000 quadrangles of the National Topographic Map Series are now published and distributed by the Geological Survey.

In 1958, as a result of a change in policy, the Geological Survey adhered to specifications for 1:24,000-scale maps in all its mapping in the United States, with the exception of that in Alaska. Although the first publication will sometimes be at 1:62,500 scale, the manuscripts will be available for future publication at 1:24,000 scale when the need arises, and copies are also furnished on special order to those who need the larger-scale compilation.

Outside the United States, the Geological Survey continued a limited mapping operation in Antarctica. An engineer was assigned to Byrd Station for an eighteen-month period to accompany a scientific traverse party and conduct geodetic surveys to determine positions of major peaks and other landmarks for mapping control. Survey engineers were members of both the Marie Byrd Land and Victoria Land traverse parties, serving as navigators and determining the geographic positions of mountain features. Another engineer on the icebreaker USS Glacier determined geographic positions on Thurston Peninsula when, for the first time in history, a ship penetrated the ice pack to reach the Bellingshausen Sea coast. An experimental 1:1,000,000-scale map in the Knox Coast area of Antarctica was prepared and printed. In addition, a comprehensive library of cartographic materials relative to Antarctica was established.

Aerial photography is now available for the entire area of the fifty states, Puerto Rico and the Virgin Islands,

as indicated on the index published by the Geological Survey in 1959. This index shows the coverage held by each federal agency, some state agencies and commercial firms.

Through the International Cooperation Administration, various federal mapping agencies of the United States extended assistance to accredited representatives of other nations. Extended courses of technical training, as well as briefer courses, were given to civil engineers and cartographers from a number of foreign countries.

On two occasions, the Geological Survey assigned a cartographer to Libya to obtain information needed for preparation of a base map of that country at the scale of 1:2,000,000. One technician was sent to Ceylon for six months to train photographic laboratory personnel and a cartographic technician was sent to Brazil to advise on the cartographic work of the Departamento Nacional de Produção Mineral and train local personnel in modern cartographic techniques.

In the category of geodetic control for topographic mapping, the Geological Survey accomplished spirit levelling to provide vertical control for 588,140 square kilometres of topographic mapping, 42,194 kilometres of transit traverse and 390,804 square kilometres of third-order triangulation. In Menlo Park, California, a building designed specifically for the production of maps was completed and occupied by the Pacific area office of the Geological Survey.

HYDROGRAPHY AND OCEANOGRAPHY

The Office of Oceanography of the United States Coast and Geodetic Survey continued a long-range programme of hydrographic surveys within the prescribed area of responsibility. Basic surveys were accomplished in the Gulf of Maine, the Aleutian Islands and along the north side of the Alaska Peninsula. Revision surveys were conducted along the Atlantic coast in various areas from Maine to Florida, on the Gulf coast of Florida, offshore and in selected bays and rivers along the Pacific coast, in the Strait of Georgia, Washington, and in various inside waters of south-east Alaska. Wire drag surveys continued along the Maine coast. Several investigations were made by wire drag of reported obstructions and wrecks along the Atlantic coast.

Based on the majority of opinions of 18,563 small craft owners and operators, the first edition of Small-craft Chart Series 101, Potomac River, was published in June 1959. This new type of chart is serving as a prototype for future selected areas. The second in this series, No. 140, Fort Pierce to Miami, Florida, was published in January 1960, the third, No. 184, Bellingham to Seattle, was published in 1961.

Oceanographic observations were made by United States Coast and Geodetic Survey ships while engaged on hydrographic surveys in Lituya Bay, Kasaa Bay, Prince William Sound, the south side of Atka and Amliia Islands, Alaska, the Bering Sea, Gulf of Alaska, Pacific Ocean, Gulf of Mexico, Atlantic Ocean and along the Massachusetts coast and in the Potomac River. The observations include 172 oceanographic stations, 236 bottom samples and 1,467 bathythermographs. Seven hundred and fifty-four water samples were completed for salinity analysis, 53 for sediment analysis, 11 sediment samples were bottled, 750 water samples were analysed for dissolved oxygen, 58 biological net tows and 15 dredge

hauls were carried out and 7,456 drift bottles were released. The magnetometer was towed 10,069 miles. During June of 1959, three surface and three 300-metre depth parachute drogues were launched and tracked along the south side of Atka Island, Alaska, and in July, two drogues were launched in Lituya Bay entrance.

As a part of the Canadian and United States effort to improve the charting for the safe navigation of vessels engaged in the establishment and resupply of Arctic weather and radar stations, the United States Navy Hydrographic Office conducted surveys in Baffin Bay and in Melville Bay, Greenland. The results of these surveys have been reflected in the improved charts now available for navigating the coastal route through Melville Bay to Thule, Greenland. Limited hydrographic surveys were also carried out in the Bahama Islands and other areas where charting is deficient. Work was begun during this period to improve the geodetic control in the Bahamas through extensions from the basic Hiran stations by tellurometer traverse to a number of high-order stations. These will be used as sites for radio positioning equipment in forthcoming hydrographic surveys.

During this period technical specifications for the World-wide Ocean Survey were completed to ensure standardization of data observations made by United States and foreign organizations during the proposed ocean surveys. These specifications reflect, wherever applicable, the survey standards of the International Hydrographic Bureau, the International Union of Geodesy and Geophysics, and the Pan American Institute of Geography and History (PAIGH).

In addition to providing the nautical and aeronautical charts required to support the annual resupply operations in Antarctica, the Navy Hydrographic Office conducted oceanographic surveys from aboard the ice breakers assigned to this task. Oceanographic observations were also made from various ships engaged in Arctic resupply missions and forecasts of ice and wave conditions were provided to vessels assigned to Arctic operations.

In order to discharge more efficiently and more effectively its responsibility for providing nautical charts and related information for safe navigation of United States ships operating in waters outside those of the United States and its possessions, the United States Navy Hydrographic Office has recently negotiated an agreement with the Hydrographic Office of Brazil whereby each office is authorized to reproduce, in modified facsimile, the nautical charts of the other office for sale to the general public. This action will enable hydrographic offices of both countries to provide their mariners with latest charts in a minimum amount of time. Similar agreements have been previously negotiated with the hydrographic services of Canada, Germany and the Philippines.

The USC & GS ship *Pioneer* initiated an ocean-wide survey programme recommended by the National Academy of Science's Committee on Oceanography of an area from the Hawaiian Islands to the Aleutian Islands. The purpose of the work was to run north-south lines, accurately controlled by Loran, for closely spaced (ten-nautical mile) oceanographic—including hydrographic—surveys in the deep sea between the Hawaiian Islands and the Aleutian Islands, Alaska. The under-way phase will consist of hydrography, magnetics, gravity, bathythermograph and meteorological observations. In addition to the above operations, a second phase will include a series

of oceanographic stations consisting of bathymetry between oceanographic stations, bathythermograph observations every two hours while under way, Nansen bottle casts, bottom samples, biological observations including plankton tows and sampling for carbon-14 determinations, current studies using parachute drogues and drift bottles, magnetometer observations, gravity meter observations and meteorological observations.

It is desired that this field season's work will provide a frame of reference within which the worth of a vastly expanding national effort in the oceanography programme may be judged.

The advent of ocean surveys created problems among which was recognized the need for a series of larger-scale plotting sheets. In consequence thereof, a master mercator projection was made on a scribe-coated Mylar sheet. When the present master sheet is engraved, stick-up prepared and a negative made, plotting sheets will be prepared on both Mylar and conventional boat sheet paper.

This series of plotting sheets is designed at a scale of one degree to 8 inches of longitude. Each sheet will have 15 minutes of overlap in longitude, 30 minutes overlap in latitude, and, with slight modifications, will fit the HO Bathymetric Chart Index.

Longitude values will not be assigned to permit complete usage within specific latitudes and to simplify reproduction. Each plotting sheet also shows latitude in reverse in order that it may be used north or south of the equator. Along the border of each sheet, there is a consecutively numbered list of latitude coverage by band widths which serves as a key to the complete series. Also shown in the border of each sheet is a table of natural scale for each 30 minutes of latitude. Logarithmic scales are printed at the top and bottom of each sheet for the user's convenience.

Charting co-ordinates for the Loran C chain will be used for plotting positions on the smooth sheets, after final calibration values are incorporated in the charting co-ordinates and the sky wave corrections are accounted for in the recorded data when applicable. Any type of control is adequate for use with these sheets.

TIDES

Control tide stations were maintained at selected sites along the coasts of the United States by the United States Coast and Geodetic Survey to provide long-period observational data. These basic data have broad application in surveying and engineering activities associated with mapping, coastal development and marine navigation, as well as in scientific studies including variations in sea level.

The new format introduced in the tide tables and tidal current tables published by the United States Coast and Geodetic Survey has been favourably received. A device was installed for use with the Coast and Geodetic Survey tide predicting machine which semi-automatically types the predictions in a form suitable for offset printing. This eliminates considerable preparation of manuscripts for the printer and expedites predictions. The programme of annual exchange of tidal predictions between the United States and a number of Afro-Asian countries was continued.

A semi-automatic tide curve scanner was placed in operation which has speeded up considerably the process-

ing of hourly heights from marigrams. An additional one is on order.

Steps have been taken to strengthen the seismic sea wave warning system in the Pacific. Efforts are being directed towards establishing additional wave reporting tide stations, improving communication techniques and preparing charts of seismic sea wave travel time to places in Alaska, Asia and Latin America, for expansion of the warning system. A preliminary report on the tsunami of 22 May 1960, as recorded at tide stations, was published by the United States Coast and Geodetic Survey.

A newly designed FM radio transmission system has been used with the Roberts radio current meter to provide more definite identification of signals through the separation of velocity and direction impulses. The new transmitters send the signals only when triggered rather than continuously as in the old-type transmitter.

AERONAUTICAL CHARTS

The great increase in air operations, with its resulting congestion of airplanes and limitation of air space, has created major problems in the control of air traffic. The changes in air traffic control procedures, the introduction of many new air navigation systems, and the increased emphasis on importance of air safety brought about extensive review and redevelopment of aeronautical charts and flight information publications. First consideration has been given to the analysis of the chart requirements for instrument flight in view of the separation of air traffic (early in 1961) into the three altitude layers—low, intermediate and high.

The publication of a new series of low-altitude en route charts in March 1961 marked the culmination of over two years of planning and co-ordination between civil and military agencies. This series of twenty-eight charts, at scales varying from 1" = 20 nautical miles co-ordinates the civil and military chart requirements for flights in the low-altitude structure. There are twenty-three area charts associated with this series which provide coverage at an expanded scale for terminal area operations.

Charts for the intermediate-altitude airways were published in April 1961 at the time this structure was implemented. The series provides coverage with eight charts at a constant scale of 1" = 28 nautical miles for flights between 14,500 feet and 24,000 feet.

Work is continuing on the development of specifications for charting the high-altitude routes. Upon approval and publication, these specifications for high-altitude en route charts will supersede the civil and military versions now being used for this route structure. Thus, an integrated family of charts for instrument flight will be available with similar format and symbolization.

A flight planning chart, scale 1:1,824,000, has been developed for wall use a supplement to the planning publication for both high-altitude and low-altitude flights. The three sheets of this chart covering the United States are now published every three months.

The aircraft position chart series was extended by coverage of routes from the west coast of continental United States to Hawaii and, by addition of a chart for the sub-polar routes, from the west coast of the United States to Europe. The Hawaiian chart is on the Oblique Mercator projection at a scale of 1:5,000,000 and was first published in September 1958. The sub-polar chart to

Europe, at the scale of 1:6,250,000 and also on the Oblique Mercator projection, was published on 1 April 1960.

Twenty-six charts in the new global navigation and planning series, scale 1:5,000,000, were published. This series meets a planning and navigation requirement for charts at the scale of 1:5,000,000. The charts are published with large area coverage and are positioned in such a manner that many long flights, particularly those over water areas, can be accomplished with a single chart. Special editions of nine of these charts include information required for Loran/Consol navigation.

Greater emphasis has been placed on development of cartographic products to meet the operational needs of chart users. In the development of cartographic methods, considerable effort has been expended in investigating the applicability of automation processes and systems to various aeronautical charting operations. Studies for possible use of automation include the processing and handling of cartographic source materials and aeronautical information, and the distribution of charts.

SPECIAL MAPS

Geologic maps

In keeping with the responsibility of the Geological Survey for investigations and explorations for minerals and mineral fuels to provide information required for the planning of industrial and defence areas, many maps were published during the reporting period. Included are geological quadrangle maps, maps of mineral investigations, geologic indexes, coal maps, oil and gas maps and charts, maps of geophysical investigations and geologic status maps, reflecting several types of cartographic work.

In addition, many geologic maps were included as illustrations in the seventy-nine professional papers, 197 bulletins and eight circulars which were published as a part of the regular Geological Survey series of publications.

Hydrologic maps

As a part of the Hydrologic Investigation Atlases, an innovation in the form of a map was developed by the Geological Survey on which areas that were inundated by floods of record are indicated. Such maps are being developed for industrial areas or urban areas particularly susceptible to flooding. Three atlases were produced by the Geological Survey reflecting in cartographic form the results of the hydrologic investigations of occurrence, magnitude, utilization and chemical and physical quality of surface and ground waters of the areas concerned. The 194 water supply papers printed in fiscal years 1958 and 1959 included a large number of geologic and special hydrologic maps.

Other special maps

Fifty-three political-physical maps are currently scheduled for the National Geographic Atlas Map Series, which are printed on standard size sheets, 19 by 25 inches. The uniform maps enable each member to build up his own world atlas, and the "bleed" design permits the use of larger scales and more detail. A folio is also available for assembling the plates of this "do-it-yourself" National Geographic Atlas.

OTHER MAPS

The United States Army Map Service has initiated revision of existing small-scale planning maps covering the world. These series at scales of 1:2,000,000 and larger will be up-dated from the latest source material and issued

in hypsographic and outline editions. Mapping has been initiated at the scale of 1:1,000,000 in the South East Asia area from available source material. Previously produced medium-scale maps are being used in compiling sheets of the series for Burma, Indonesia, Malaya and Thailand.

The Navy Hydrographic Office published during the reporting period two new atlases: Oceanographic Atlas of the Polar Seas and Climatological and Oceanographic Atlas for Mariners, vol. I, the North Atlantic Ocean. The latter publication was a joint effort of the United States Weather Bureau and the Navy Hydrographic Office.

Cadastral surveys

The Bureau of Land Management of the United States Department of the Interior is the agency authorized to execute the official cadastral surveys and resurveys of the public lands of the United States. The survey record represents the descriptive title of approximately 1,718,750 square miles (4,451,562 square kilometres) of land which the Federal Government has patented from the public domain. Except for Alaska, only a small part of the public lands has not been covered by the rectangular public land cadastral survey system. In Alaska, less than one per cent has been surveyed.

Electronic distance measuring equipment, which has been put to use in geodetic and topographic surveys is equally adaptable to cadastral surveys, and the Bureau of Land Management is constantly making more use of it, especially in Alaska where rugged topography and inaccessible country require a less laborious method than the conventional chaining.

Photogrammetry has been used in connexion with transit and tape measurements for determination of meander lines. Since 1957, experimental work has been completed for two projects which make use of stereophotogrammetry along with ground methods for original land surveys. The results of these projects indicate that the procedure is practical if it is used on the right type of terrain. The problem differs from that usually encountered in Asia, in that the property corners are set as a result of the survey; in Europe the monuments are generally previously established and the survey determines their co-ordinates.

URBAN AREA SURVEYS

The official responsibility for engineering surveys and maps of urban areas in the United States is that of the local governments. To report the progress made in these areas, it was necessary to contact the respective engineering or survey departments charged with these responsibilities.

Requests for reports of the progress made were sent to 291 cities with populations of 50,000 or over. Approximately 60 per cent of these cities replied to the questionnaire. The progress made in the remaining 40 per cent was not available for this report. Because of the variable

conditions pertaining to operations and maintenance in those cities that did not report and in those included in the 10,000 to 49,000 population class, no attempt was made to estimate the progress in these categories.

Because the local governments have jurisdiction over surveys and maps in their respective areas, various methods and procedures have been adopted. In essence, some local governments are continuing the same practices as those initiated when the cities were founded or incorporated. Such practices do not conform to present-day specifications and recognized standards of accuracy. Any changes from the former procedures and methods to the multiple uses of the precision engineering survey structure cannot be effected rapidly. The extent to which progressive changes are made, however, is generally based upon three important factors: (1) the availability of funds; (2) the degree of acceptance to change, and (3) the extent to which growth and development make necessary a more positive economic approach to planning and operating problems.

During the reporting period, there was a distinct increase in the number of cities using photogrammetric methods for large-scale planimetric and topographic maps. This was the predominant method used even in those cities having comparatively small areas. Also, the number of cities tying in the underground and surface public utility structures to the horizontal control increased. This procedure, however, is practised in comparatively few cities.

OTHER ACTIVITIES

In the past decade, certain problems relating to the professional status of its surveying-mapping members prompted the American Society of Civil Engineers (ASCE) in 1954 to inaugurate a study of surveying and mapping activities in the United States. A Task Committee on Status of Surveying and Mapping was appointed to report on two questions:

- (a) Which parts or activities of surveying and mapping are professional, and which are not?
- (b) Which parts or activities of surveying and mapping are engineering, and which are not?

The Task Committee made its final report in October 1958, and this report was endorsed by the Executive Committee of the ASCE Surveying and Mapping Division. The ASCE Board of Direction, at its 9 February 1959 meeting, voted to adopt as ASCE policy the statement:

"The American Society of Civil Engineers, on the basis of thorough studies carried out by a Task Committee on the Status of Surveying and Mapping, asserts that the following four major categories of activities commonly designated as surveying and mapping are a part of the civil engineering profession: I. Land Surveying; II. Engineering Surveying; III. Geodetic Surveying; IV. Cartographic Surveying".

Addenda

"Use of Shoran-controlled Aerial Photography in Medium-scale Mapping." The accuracy of Shoran has improved to the point where it is capable of providing horizontal accuracy for 1:100,000-scale maps. The tests to determine suitability for 1:50,000-scale mapping will

be completed in December 1961. The accuracy is improved by controlling the strength of the signal; this system is known as Hiran. A more recent system (Shiran), which is currently under development, will be capable of position determination based on four ground

stations instead of two only. The redundancy of measurements will increase accuracy and reliability of positions so determined.

"Consequences of the Application of Electronics to Photogrammetric Production of Maps." The Army Map Service expects delivery of a prototype on an advanced model of the "Stereomat" in February 1962 and expects the final model to be completed near the end of 1962. This device automatically orients photography, produces orthophotography and plots contours. It is ten to twenty times faster than stereo instruments used at present and provides twice the accuracy.

The Army Map Service expects delivery on a prototype of the Integrated Mapping System during September or October 1961, but the final model is not expected to be completed until two or three years later. This is an automatic profile scanning device to be used for locating contours, but which, in addition, records on tape data to be used in connexion with plastic relief mapping.

"Importance of Auxiliary Instruments in Photogrammetry." The accuracy of the statorscope and the air-borne profile recorder for height determination has been tested in the United States. One test conducted at the Army Map Service yielded a mean error in elevation of ten feet in flat terrain and twenty feet in mountainous terrain when the auxiliary data were used in conjunction with stereophotogrammetric bridging. The photography was flown at an altitude of 30,000 feet and only the termini, which were 215 miles apart, were datumized to vertical ground control.

"Adjustment of Aerial Triangulation According to the Method of Least Squares by Means of Analogue Computers." The Army Map Service has programmed a horizontal block adjustment for use with digital electronic computer. The method, in principle and in accuracy of results, is comparable to the method devised by Dr. Jerie. The chief advantage of the AMS method is the speed with which the adjustment is completed.

"International Standardization of Sheet Lines and Projections for 1:1 Millionth-scale Series." Since the UTM grid is now shown on the 1:1,000,000-scale maps, the north polar region limits should be extended to 84° N to conform with the extended limits of the UTM grid.

Gravimetry. The United States Navy Hydrographic Office has successfully employed LaCoste and Romberg gravity meters aboard submarines and surface ships. A concerted programme to collect ocean gravity observations has been under way since May 1960 to provide data for use in various geodetic, navigational and oceanographic programmes. Computation of deflection of the vertical by astro-gravimetric methods has been accomplished at several isolated islands. The ultimate goal is a general gravity survey of all ocean areas. Current development activity on an air-borne gravity meter will probably make this an important reconnaissance instrument within the next year or two. Other types of sea gravity meters are also being tested and evaluated as they become available.

Hydrography and oceanography. As a part of the Canadian and United States effort to improve the charting for the safe navigation of vessels engaged in the establishment and resupply of Arctic weather and radar stations, the United States Navy Hydrographic Office conducted surveys in Baffin Bay and in Melville Bay, Greenland.

The results of these surveys have been reflected in the improved charts now available for navigating the coastal route through Melville Bay to Thule, Greenland. Limited hydrographic surveys were also carried out in the Bahama Islands and other areas where charting is deficient. Work was begun during this period to improve the geodetic control in the Bahamas through extensions from the basic Hiran stations by tellurometer traverse to a number of high-order stations. These will be used as sites for radio positioning equipment in forthcoming hydrographic surveys.

During this period, technical specifications for the World-wide Ocean Survey were completed to ensure standardization of data observations made by United States and foreign organizations during the proposed ocean surveys. These specifications reflect, wherever applicable, the survey standards of the International Hydrographic Bureau, the International Union of Geodesy and Geophysics and the PAIGH.

In addition to providing the nautical and aeronautical charts required to support the annual resupply operations in Antarctica, the Navy Hydrographic Office conducted oceanographic surveys from aboard the ice breakers assigned to this task. Oceanographic observations were also made from various ships engaged in Arctic resupply missions and forecasts of ice and wave conditions were provided to vessels assigned to Arctic operations.

A new multicoloured wall chart of the world will shortly be published by the United States Navy Hydrographic Office. This chart (HO 15,254) will be printed in twelve sections and, when assembled, will measure 8 feet by 12 feet. Centred on the western hemisphere, it is drawn on the Mercator projection at a scale of 1:12,233,000 and covers the area between 84° North and 70° South. Two additional sheets covering the polar areas are planned for production in the near future.

The new chart will contain a generalized portrayal of both bathymetry and topography through the use of gradient tints of blue and shaded brown. Principal cities, ports, shipping routes and pack ice limits will be shown.

A small-scale chart (HO 14,200 at scale 1:732,000) is now available for the area from Hong Kong in the north to Borneo in the south. Centred on Manila, it includes all of the Philippine Islands. Included in the detail shown on this chart is the recommended north-east monsoon season ship route on the western side of the Philippines, the delimiting danger line around the dangerous ground area and lines of magnetic variation at one-degree intervals.

The most recent editions of magnetic charts (HO 1,706 and HO series 15,281') containing isogonic lines of magnetic variations were published during 1960. New editions of these charts are printed every five years while charts containing vertical and total intensity data are revised on a ten-year basis. The next editions of the latter charts (HO 1,702 and HO 1,703) are due in 1965.

In December of 1958, the United States Navy Hydrographic Office issued a new edition of the American Practical Navigator commonly known as "Bowditch". This publication provides a complete and modern textbook on the theories of navigation and the methods and techniques employed in their application.

AGENDA ITEM 7

Reports on progress in matters which formed the basis of the resolutions or recommendations at the last Conference

COMMENTS ON RESOLUTIONS ADOPTED AT THE SECOND UNITED NATIONS REGIONAL CARTOGRAPHIC CONFERENCE FOR ASIA AND THE FAR EAST, TOKYO, JAPAN, 20 OCTOBER – 1 NOVEMBER 1958¹

The resolutions adopted at the Second United Nations Regional Cartographic Conference for Asia and the Far East, held in Tokyo, Japan, from 20 October to 1 November 1958, have been reviewed by the United States and comments on pertinent resolutions are as follows:

Resolution 3. Establishment of long standard base lines for calibrating geodimeters and other radio-electric and electromagnetic devices, as well as for assuring the accuracy of the networks

While this resolution suggests at least one base line for each country of not less than ten kilometres in length for calibration purposes, there is merit in the idea of employing the Väisälä light-interference comparator. The standard length of such a base line is 864 metres and the method is probably the most accurate available. The geodimeter, if properly calibrated and handled by experienced personnel, is a very dependable device for length measurement. We believe that if this instrument is calibrated on the 864-metre base, then it can be used with confidence for first-order base line work and in laying out calibration bases for electronic distance measuring equipment in the electromagnetic wave range. In this way, countries of large areas could easily lay out a number of geodimeter base lines for the calibration of electronic equipment.

There is a distinct advantage in the shorter base line for geodimeter calibration in that average temperatures and humidity readings can be determined much better than over a line ten kilometres or longer.

The length of several of the standard base lines established with the Väisälä comparator at 864 metres has been measured in various parts of the world. These are excellent for obtaining uniformity in standards of length when using invar wires or tapes. This length of line might be adequate for standardizing and calibrating the geodimeter instruments but it is not adequate for standardizing electronic magnetic instruments.

The geodimeter is a very dependable instrument and could be used to establish a standard base line for all types of electronic distance measuring equipment. A base line for this purpose should be at least ten kilometres long.

At the last General Assembly of the International Union of Geodesy and Geophysics, the International Association of Geodesy adopted several resolutions which pertain to the use of electronic distance measuring instruments.

First, the geodimeter is recognized as suitable for measuring geodetic base lines; secondly, the tellurometer may be used in primary geodetic work if the techniques prescribed in the report of Special Study Group No. 19 are followed. The observation programme should consist of not less than six sets of observations spread over not less than two days in favourable atmospheric conditions and three days in unfavourable conditions. Each set should cover the whole range of frequency. Sides of two or more triangles in figures should be measured. In no case should a single side be measured with an electromagnetic instrument and used as a base.

At the General Assembly in Toronto 1957 the Union adopted a standard value for the velocity of light in vacuum 299,792.5 plus or minus 0.4 kilometres per second. In order to achieve further uniformity in calculation, the International Association of Geodesy at Helsinki in 1960 adopted resolutions on the subject.

Resolution 5. Classification and standards of accuracy of geodetic control surveys

Not much can be reported on this item except, perhaps, that in recent years there is a tendency, particularly in European countries, to tighten up the accuracy of control surveys even further than outlined in our present standards. The International Association of Geodesy recommends 1:100,000 for the best first-order triangulation. These higher accuracies can be more easily attained than in former years because of the availability of distance measuring equipment, such as the geodimeter.

Resolutions 6 and 7. Use of the geodimeter in geodetic surveys and use of the tellurometer in geodetic surveys

The Coast and Geodetic Survey has used the geodimeter and tellurometer extensively in the past several years. The geodimeter now is employed almost exclusively for the measurement of first-order base lines. Beginning in 1955, the Coast and Geodetic Survey have to date measured 168 base lines with this instrument and additionally forty-three lines in connexion with the super-accurate project for the Air Force in the Cape Canaveral, Florida, area. This project consists of an area of some 4,500 square miles covered completely with a network of triangulation quadrilaterals. Of the 200 lines composing this triangulation scheme, forty-three were measured by the geodimeter. The purpose of this scheme was to locate very accurately, in relation to the Cape, nine ballistic cameras at distances from forty to nearly seventy miles. These cameras were to be used to photograph missiles

¹ The original text of this paper, submitted by the United States of America, appeared as document E/CONF 36/L.30.

in flight against the star background in order to determine space positions of the missile along its path.

The adjustment of this triangulation-geodimeter network indicated a very high degree of precision. The geodimeter measurements were entered as observations along with the direction measurements in the adjustment and given a weight equal to the direction measurements. The probable error of a single observation turned out to be better than one part in 1,000,000, indicating the superior quality of the geodimeter as a distance measuring device.

The United States Coast and Geodetic Survey has also made excellent use of the tellurometer, particularly in connexion with the Interstate Highway programme. On these projects, which are co-operative with the states, something over 5,000 kilometres of tellurometer traverses have been computed along the proposed highway routes. The tellurometer was used exclusively in measuring the traverse lengths which averaged about five kilometres. These traverses were connected to the triangulation and a simultaneous adjustment was made of the lengths and directions. Because the tellurometer does not have the accuracy of the geodimeter, these observations were given less weight than those for the directions. The average correction to a tellurometer length was something of the order of one part in forty or fifty thousand, indicating how satisfactory the performance of the tellurometer has been.

The tellurometer has also been used for first-order base lines, but always depending on the measurement of several lines in a figure—never on one line. Moreover, these lines should be at least fifteen kilometres long, preferably twenty kilometres or more. Several such bases were measured in Ethiopia.

Resolution 8. Maintenance of national standard magnetometers and their comparison

The United States, by the Coast and Geodetic Survey, is pleased to report substantial progress along the lines of this resolution. At their Fredericksburg Magnetic Observatory, since early in 1959, the Coast and Geodetic Survey have had in routine use for observing the horizontal, vertical and total intensity a proton vector magnetometer made according to Nelson's arrangement. The results show very high internal consistency, good conformity of the component determinations with the total intensity measures, and excellent agreement of the horizontal intensity values with electromagnetic observations using a sine galvanometer. For the first seven months of 1961, the latter comparison indicates an average difference of only 0.3 gamma, which is not considered significantly different from zero (Bottum, Gebhardt and Townshend, 1961).

In view of the excellent performance of this instrument, steps have been taken toward the provision of similar equipment for certain other Coast and Geodetic Survey observatories. The facility with which the readings can be made leads to more frequent control and permits observations at times when moderate activity might interfere with conventional methods of observing. The improved control of base line values is particularly striking for vertical intensity, which normally required the trigonometric reduction of dip observations to vertical intensity, and thereby makes the control of the vertical intensity dependent on knowledge of horizontal intensity.

Resolution 9. Observation of national gravimetric nets and their international connexion

The primary objective of Section IV (Gravimetry), International Association of Geodesy of the International Union of Geodesy and Geophysics, is to promote and assist on a world-wide basis the activities stated in the above resolution. The International Gravimetric Bureau is a permanent organization with an office in Paris, and operates under the directorship of Professor Pierre Tardi with guidance by the International Gravimetric Commission and the International Association of Geodesy. The Commission holds meetings in Paris every three years, the next being in September 1962. Most of the co-operative planning for international gravimetric activities is done at these meetings.

Study Group No. 5 of the International Association of Geodesy is charged with responsibility for development and adjustment of the international gravimetric network as a whole. Recent status of this work is set forth in "Report of Special Study Group No. 5 on the Absolute and First-order World Net, Paris, 1959", with a supplement prepared for the Twelfth General Assembly of the International Union of Geodesy and Geophysics at Helsinki, July-August 1960. Other phases of gravimetric activities are covered in the "General Report on Relative Measurement of the Intensity of Gravity", by Dr. S. Coron of the International Gravimetric Bureau, the latest of which was delivered at Helsinki in 1960. There is also a periodic study group report on gravity at sea.

The resolution urges the promotion of international connexions, national gravity nets and gravity measurement at sea. All of these activities are promoted on a continuing basis by the International Association of Geodesy organizational structure as outlined above. The resolution further urges that reports be made "to the national agencies and international organizations concerned". This is accomplished through the various reports listed above and through the employment of the International Gravimetric Bureau in Paris as a clearing house for information.

A considerable amount of gravity data has been accumulated in certain portions of Asia and the Far East in recent years. This is indicated in the various reports cited above. However, the progress has been very slow or nil in other areas. Development of national networks ultimately depends on the needs, resources and initiative of the individual nations concerned. Maximum benefit from the promotional, advisory and informational functions of the international organization requires widest participation by the individual nations.

There is a recommendation that sea gravity meters recently developed be used effectively in the vast sea area in this region. There is nothing very specific to report on this item. However, it is known that the Scripps "Monsoon" expedition of the Argo made gravity observations with a LaCoste-Romberg sea gravity meter on the 1960-1961 cruise to New Guinea, Australia, Mauritius and Tahiti.

Since April 1961 a LaCoste-Romberg sea gravity meter has been in continuous operation on the Coast and Geodetic Survey Ship Pioneer for measurements along track lines between the Alaskan peninsula and Hawaii. Gravity readings have been possible for a high percentage of the operating time, but evaluation of accuracies attained must await further analysis of the data and post-season labora-

tory investigations. A second LaCoste-Romberg sea meter will be installed on the Survey Ship Surveyor early in 1962.

In order to provide suitable control data for evaluating performance of the sea gravity meters under actual operating conditions, a shoal area will be surveyed with an underwater gravity meter off the Pacific coast near San Francisco in May 1962. The area will cover approximately 1,000 square miles and provide several operating tracks of up to fifty miles in length to permit testing under various types of sea conditions.

Gravimetric observations are being made by the Coast and Geodetic Survey Ship Pioneer in the Pacific along the track lines which are spaced ten miles apart. It is planned to make additional observations on the Surveyor or Pathfinder, when another gravimeter is obtained.

Resolution 13. Special charts for the exploitation of sea resources and marine construction works

The Coast and Geodetic Survey is working with the Edgerton, Germeshausen and Grier deep sea stereoscopic camera system. Excellent results have been obtained in taking 2 by 4-metre samplings of the ocean floor with stereoscopic colour photographs suitable for topographic mapping with third-order stereoscopic plotters. The camera system is designed to work to depths in excess of 6,000 metres and contains two cameras, an electronic flashlight source, a sonar pinger for camera-to-bottom distance measurement and battery power for 500 stereoscopic pairs of photographs per camera lowering.

Bottom topographical charts by colour aerial photogrammetric methods are discussed and illustrated in the paper on "Photogrammetric Surveys for Nautical Charting—Use of Colour and Infra-red Photography".²

Resolution 16. Use of Shoran controlled aerial photography in medium-scale mapping

The accuracy of Shoran has improved to the point where it is capable of providing horizontal accuracy for 1:100,000-scale maps. The tests to determine suitability for 1:50,000-scale mapping will be completed in December 1961. The accuracy is improved by controlling the strength of the signal; this system is known as Hiran. A more recent system (Shiran), which is currently under development, will be capable of position determination based on four ground stations instead of two only. The redundancy of measurements will increase accuracy and reliability of positions so determined.

Resolution 17. Consequences of the application of electronics to photogrammetric production of maps

The Army Map Service expects delivery of a prototype

² Reproduced in the present volume under item 14 of the agenda.

of an advanced model of the "Stereomat" in February 1962 and expects the final model to be completed near the end of 1962. This device automatically orients photography, produces orthophotography and plots contours. It is ten to twenty times faster than stereo instruments used at present and provides twice the accuracy.

The Army Map Service expects delivery of a prototype of the Integrated Mapping System during September or October 1961, but the final model is not expected to be completed until two or three years later. This is an automatic profile scanning device to be used for locating contours, but in addition it records on tape data to be used in connexion with plastic relief mapping.

Resolution 18. Importance of auxiliary instruments in photogrammetry

The accuracy of the statoscope and the air-borne profile recorder for height determination has been tested in the United States. One test conducted at the Army Map Service yielded a mean error in elevation of ten feet in flat terrain and twenty feet in mountainous terrain when the auxiliary data were used in conjunction with stereophotogrammetric bridging. The photography was flown at an altitude of 30,000 feet and only the termini, which were 215 miles apart, were datumized to vertical ground control.

Resolution 19. Adjustment of aerial triangulation according to the method of least squares by means of analogue computers

The Army Map Service has programmed a horizontal block adjustment for use with digital electronic computer. The method, in principle and accuracy of results, is comparable to the method devised by Dr. Jerie. The chief advantage of the AMS method is the speed with which the adjustment is completed.

Coast and Geodetic Survey methods are set forth for horizontal and vertical least squares adjustment of strip aerotriangulation in Technical Bulletins 1 and 10. A more descriptive presentation of instrument aerotriangulation and its adjustment was presented at the 1960 Bangkok Regional Conference under the title "Horizontal and Vertical Instrument Aerotriangulation". The paper to be distributed at the 1961 Bangkok Conference presents the Coast and Geodetic Survey analytic aerotriangulation system which includes a least squares fitting to geodetic control.

Resolution 25. Infra-red photography

Coast and Geodetic Survey accomplishments in the application of colour and infra-red photography to the problems of photo-interpretation in nautical chart construction were presented in a paper at the London Congress of Photogrammetry in 1960.

AGENDA ITEM 8

Establishment of a regional inter-governmental cartographic organization

PROPOSAL SUBMITTED BY THAILAND¹

The question of the establishment of a regional inter-governmental cartographic organization was studied by the first United Nations Regional Cartographic Conference for Asia and the Far East, held in Mussoorie, India, in 1955. The Conference recommended "the setting up of regional inter-governmental cartographic organizations where these do not exist at present: these would form an authoritative source for advising Governments of the Region on their cartographic problems and on the vital need for giving primary importance to cartographic self-sufficiency as a prerequisite to orderly economic development". The Economic and Social Council, in reviewing the report of the Conference, further recommended that "those regional economic commissions which think it desirable consider the question of establishing cartographic committees for the purpose of periodic consultation... among their members".² The Second United Nations Regional Cartographic Conference for Asia and the Far East expressed the hope that the Economic Commission for Asia and the Far East would study the possibility of taking concrete steps for organizing regional inter-governmental channels of co-operation in the field of cartography, including the establishment of an appropriate regional machinery. The Commission which met in Australia in March 1959 expressed the opinion that the question of establishing regional inter-governmental machinery for cartography might be considered at a later date, in the light of subsequent experience.

NEW PROPOSAL

The establishment of a large regional cartographic organization involving heavy expense may not be feasible

¹ The original text of this paper appeared as document E/CONF.36/L.14.

² Economic and Social Council resolution 600 (XXI), paragraph 3.

at the present time. It is, therefore, suggested that a more realistic approach be taken in order to meet the urgent need for certain tasks to be performed by the proposed organization.

As a first step, an attempt should be made to set up a regional training and study centre with the following functions:

- (1) To provide technical training for staff in various techniques of map making, including assistance to trainees in obtaining scholarships;
- (2) To give advice for studying technical problems encountered by countries of the region;
- (3) To serve as a centre of management for co-operative projects.

The setting up of such a centre must be preceded by a study of detailed procedure to be followed as well as of the organizational structure to be adopted. The implementation of the proposal requires the agreement of the interested countries. For the purpose of carrying out the preliminary study, it is suggested that a working group be constituted, composed of representatives of interested countries, to examine all the problems connected with the setting up of such a centre, including the preparation of a programme of work. The small group should also study the other proposals of regional cartographic importance, such as the setting up of:

- (a) A regional training centre for surveying and mapping;
- (b) A regional training centre for aerial surveys;
- (c) A regional training centre for photo-interpretation;
- (d) A central organization for compiling and printing a regional economic atlas;
- (e) A regional inter-governmental cartographic organization.

AGENDA ITEM 9

Establishment of a regional training centre for surveying and mapping

PROPOSAL SUBMITTED BY CHINA¹

The planned development in the Far East of such natural resources as forests, minerals and hydroelectric power and of land use has been accomplished only in recent years owing to the scarcity of information which could be used as reference material.

By applying the new methods of aerial survey and aerial photo-interpretation to surveying techniques and the making of topical maps, much information can be obtained in less time, at a lower cost, and with greater precision than in the past. Courses in aerial survey and resources inventory are not yet included in the curricula of the colleges in most of the countries of the Far East. Accordingly, these countries are short of technicians in aerial surveying and the development of their natural resources is extremely slow.

¹ The original text of this paper appeared as document E/CONF. 36/L.62.

To accomplish the research and investigation of the natural resources in the region for development in the near future, it is urgently necessary to establish a research and training centre for aerial surveying in the Far East, in order to give the technicians concerned the necessary training.

If this proposal is acceptable, the Republic of China could make the necessary training easily available since it has already had good practical experience in such resources projects as land use and forest resources survey, national forest management planning survey, hydraulic power topical mapping, flood disaster survey and planning for development of tidal lands. The country also has skilled technicians, considerable accommodation and equipment. Moreover, it is believed that its location is the most suitable one in the Far East.

In conclusion, it is proposed that an aerial survey centre for the Far East be established in the Republic of China.

PROPOSAL SUBMITTED BY INDIA¹

The facilities for training in surveying, mapping, photogrammetry and hydrography in the ECAFE region are not adequate at present. A number of surveying personnel are therefore sent to Europe and the United States to acquire the necessary technical knowledge and skill for undertaking surveying tasks in their respective countries. Taking this into consideration, several countries represented at this Conference have expressed the view that the establishment of a regional training centre is most desirable.

The Indian delegation are of the opinion that urgent measures should be taken to give effect to these recommendations so as to meet the needs of the fast developing economies of the region.

In the last meeting of the working group formed for this purpose, the view was expressed that the location of the regional centre should be decided after taking into consideration the existing training facilities in the various countries comprising the region. It is understood that this principle has been followed in the past when deciding upon the locations of regional centres, since a primary consideration governing such a decision is the most economical and expedient expansion of the existing training facilities.

Below is a brief summary of the training facilities that exist in India.

¹ The original text of this paper appeared as document E/CONF. 36/L.86.

(a) A training institution for surveying, mapping and photogrammetry. The present course in surveying and mapping is of two years' duration, and this is followed by a one-year course in photogrammetry. The number of students is about fifty per course and this number can easily be increased.

(b) A wide range of photogrammetric equipment is available and more is being acquired.

(c) Research cells in photogrammetry, geodesy and cartography are being formed and some of the latest electronic equipment is being acquired.

(d) A large photographic library exists and more photographs can be taken by the existing national photographic agency.

(e) A hydrographic school exists for the purpose of training surveying officers as well as surveying recorders. Theoretical and practical training in the various aspects of hydrography are given.

India has already been providing training facilities in the Survey of India to neighbouring countries for training their officers in surveying and is willing to extend these facilities further.

The Government of India would be happy to provide host facilities for the proposed regional training centre.

United Nations assistance would be required for the provision of certain additional equipment and staff for expanding the existing training facilities.

PROPOSAL SUBMITTED BY THAILAND¹

INTRODUCTION

Due to the lack of experience in photo-interpretation, a number of countries in the ECAFE region have not been able to survey and make inventories of their natural resources to the desired extent. Although there are several institutions giving instruction in photo-interpretation, they are usually located in distant countries and sending trainees to them involves heavy expenditure. Moreover, some countries find it difficult to obtain yearly appropriations large enough for local fellowships and scholarships. Certain countries have sent groups of students with the intention of organizing their own services, but it was found that the trained technicians still did not possess experience comparable to that of the staff members of the institution in which they had been trained.

PURPOSE

The regional centre is to be established for training technicians in interpretation of aerial photographs for the inventory of natural resources. The centre should be so located geographically that travelling expenses of the trainees would be small.

BACKGROUND

The establishment of a regional training centre has been studied at previous conferences, namely,

(a) At the Mussoorie Conference (1955) and at the Tokyo Conference (1958), discussions were held on the question of establishing an inter-governmental cartographic organization for Asia and the Far East (item proposed by the delegates of Burma and Thailand);

(b) The United Nations Seminar on Aerial Survey Methods and Equipment, held in Bangkok in 1960, recommended the setting up of a regional training centre for aerial surveying.

COMMENTS

A proposal for establishing a regional training centre for surveying and mapping should also be brought up for discussion. It is apparent that among the proposals for a regional body, each one is different from the others with respect to the substance and task of the organization. The proposal of the delegation of Burma for an inter-governmental cartographic organization may not easily be materialized because of the large funds needed. The regional training centre for photo-interpretation is considered more practicable than the other projects, as the equipment needed is not very expensive, and a relatively small staff is required to operate the centre. Therefore,

priority could be given to this project as it is not difficult to establish such a centre.

RECOMMENDATIONS

Function

The centre should admit trainees from countries members of ECAFE. The trainees should be instructed both in theory and practical work up to a level sufficient for carrying out the national projects for natural resources inventories.

Location

The centre should be located in a city in the ECAFE region involving minimum travelling expenses for trainees. It should be located on an international route where modern means of transportation are regularly available. The living cost in the city should be reasonably low. The facilities of local travelling for field studies should be ample. Proper consideration should also be given to the centre's proximity to the body responsible for the administration of the centre.

Capacity

The centre should take fifty trainees as a starting capacity. Each country is requested to make known the number of their trainees so that the total number of students can be determined.

Staff

The staff of the centre should be familiar with the characteristics of the region, including technical background, national culture and special methods suitable to the region.

Expenditures and responsibilities

The host government should provide buildings and ground for free use by the centre. The cost of equipment and the salaries of teaching staff should be borne by the United Nations. The centre should be under the supervision of ECAFE.

Courses

At least four courses should be given at the centre, i.e. photogeology, photo-interpretation for soil survey, photo-interpretation for forestry survey and photo-interpretation for town planning. The courses should take six to nine months, including lectures, laboratory and field work.

Working group

A small group should be set up to study the questions related to the establishment of the centre, in particular to draft the structure of the centre, together with an estimated expenditure for submission to the United Nations, and to recommend the procedure to be followed. The group could call upon experienced persons for advice.

¹ The original text of this paper appeared as document E/CONF. 36/L.8.

AGENDA ITEM 10

Geodesy

(a) Review of new techniques and developments

WORLD COVERAGE BY SATELLITE GEODESY¹

Background paper submitted by Japan

In co-operation with the United States of America, the Philippines and China, Japan has, since 1952, been engaged in the work of international connexion of geodetic co-ordinates by means of occultation of star by the moon on the equal limb line. Since the investigation of this problem by the use of artificial satellites has proved to be

more efficient, it would be necessary to consider in future the setting up of a working group, composed of countries of Asia and the Far East, interested in the international connexion of geodetic co-ordinates by the moon and by artificial satellites and in the determination of the figure and the gravity field of the earth by observation of the satellite orbit; to discuss and study such questions as methods of observation, planning of work, exchange of observed data, possible establishment of a computation centre, etc.

¹ The original text of this paper appeared as document E/CONF.36/L.5.

INVESTIGATION OF THE AIR-BORNE PROFILE RECORDER¹

Technical paper by Chester C. Slama, United States Army Map Service

Army Map Service attention was directed to the potentialities of the radar altimeter method of datum control principally by the published results of tests performed by Mr. T. J. Blachut of the National Research Council of Canada. In mid-1955, Mr. Charles Price of the Army Map Service spent three months at the National Research Council in Ottawa, Canada, to participate in a test being performed by Mr. Blachut and his staff. As a result of the excellent accuracies achieved in that test, AMS decided that it should investigate the radar altimeter in terms of its value to the AMS mapping programme.

The objectives of the AMS investigation were twofold. The first objective was to provide information regarding the expected accuracies of the radar altimeter system of datum control under current AMS mapping conditions. The second objective was the determination and development of optimum production techniques and the training of key personnel in the application of radar control to photogrammetric aerial triangulation.

To ensure that these objectives could be met, a careful study was made to select a test area that would satisfy several conditions. The first condition was that the area must contain an adequate amount of photo-identifiable vertical control to be used as a yardstick for the accuracy evaluation phase. The ideal condition, of course, would have been to have accurate horizontal and vertical positions for selected radar points throughout the length of the flight line. This condition, however, would have required 1,400 miles of geodetic traverse and level lines, and could have proved to be very expensive. The next best solution

was to have geodetic ground control at intervals along the flight line and to extend this control by using photogrammetric methods. In this manner the accuracy of the co-ordinates determined would be proportional to the spacing of the control along the flight. Since the design characteristics of the radar, with regard to accuracy, are centred around ten feet, it was decided that photogrammetric extension would not have to exceed this value in final accuracy.

The second condition to be met was dictated by the radar method itself. The Air-borne Profile Recorder is a radar timing device that transmits a high-frequency wave downwards by means of a parabolic reflector-type antenna. The instrument measures the time required for the wave to travel from the aircraft to the ground and back to the aircraft. One-half of this measured time is then converted electronically into feet and recorded on a graph. This value in feet then represents the distance of the aircraft above the terrain. Thus, our problem was to determine from what point or group of points the wave was reflected. The purpose of the parabolic reflector is to narrow the cone angle of radiation to a minimum. The Electronics Associates' equipment used in this test operates in the S-frequency band, uses a parabolic reflector four feet in diameter and provides a beam cone angle of 1.6 degrees. The area of ground "illuminated" is approximately twenty-eight feet in diameter per 1,000 feet of altitude. From this it can be seen that the distance recorded on the profile graph is actually an average of the distances from the ground area illuminated. To zero the profile vertically to a known datum, therefore, the clearances must be measured over a flat area to give a reliable figure. This condition dictated our second requirement for the test area. A flat surface of known elevation was required at

¹ The original text of this paper and those of the following four papers were submitted by the United States of America and appeared together as document E/CONF.36/L.32.

each end of the flight lines to serve as datum points. Also, because of the proposed length of lines on the project, similar areas had to be provided along the flight line to allow for a break in the profile for changes of film and graph paper.

The third condition to be satisfied was dictated also by the peculiarities of the radar equipment. Because of the size of the area illuminated at any one time by the radar beam and because of the inherent lag in the electronic and mechanical components of the radar equipment, elevations recorded in rough terrain are much less reliable than those recorded over flat terrain. Even though the instrument is equipped with automatic gain circuitry, variations in signal intensity—mainly caused by variations in the reflective properties of the terrain—tend to produce additional errors in the recorded clearances. To make a thorough study of the effects and magnitudes of these errors, it was decided that the flight line should cover areas having abrupt changes in elevation, flat desert-type areas, large areas of dense vegetation coverage and should pass over large and small cities.

The fourth, and most important, condition from the standpoint of economy and realism was the question of weather conditions. To test the radar altimeter over the lengths of flight lines proposed, the area involved would cover approximately 57,000 square miles. Thus, to complete any one flight in the project, perfect photographic weather conditions would have to exist over an area comparable to the size of Illinois for a continuous period of about six hours.

The area selected as best fitting these conditions is in southern California. It extends from the Pacific Ocean on the west to Lake Meade, the site of Boulder Dam, on the east. In the north-south direction it extends from Los Angeles to Camp Roberts, California. The elevations vary from sea level to 8,000 feet; the terrain includes both desert and mountainous types. Almost all types of reflective surfaces, such as sand, vegetation, water and built-up areas, are included.

The flight lines were planned to take advantage of all the control existing in the area. It was decided that each flight should begin and terminate over the ocean. The most favorable sites were Newport Beach in the south and Paso Robles to the north-west. To provide a period for film and graph paper changes, the flights were designed to pass over Searles Lake and Lake Meade.

Flight altitudes were specified as 20,000 and 30,000 feet above sea level. While AMS is primarily interested in the feasibility of using APR data flown simultaneously with 30,000-foot photography, the inclusion of one APR flight at 20,000 feet for this test was considered necessary for several reasons. The first, and rather pessimistic, reason was the possibility that APR might prove incapable of furnishing satisfactory data from 30,000 feet. Because the system at that time had not been tested above 20,000 feet, this possibility had to be recognized. In the event our pessimistic viewpoint proved to be correct, it was considered that APR flown at lower altitudes over areas covered by Shoran photography would still provide a potential that would be worthy of AMS consideration. The second possibility was that APR data procured at 30,000 feet might be unsatisfactory, but could not be proved to be so without comparing it directly to a similar flight over the same line at 20,000 feet—the highest altitude at which APR had previously been successfully tested and used. Questions as to what part of the total error was

due to the altitude and what part was due to crew performance, latitude, distances and general performance of the equipment would arise undoubtedly. It seemed reasonable that these questions could be most accurately, rapidly and economically resolved by direct comparison between the accuracies achieved at a previously tested altitude on the one hand and the heretofore untested altitude on the other.

The third, and most optimistic, reason for the inclusion of the 20,000-foot flight was the possibility that the equipment would function satisfactorily at both altitudes. In this case, there was visualized a future requirement for an extrapolation to determine the expected accuracies at altitudes above 30,000 feet. APR data at the two altitudes over the same area, supplemented by meteorological information on the non-linearity of pressure gradient at high altitudes, would provide at least a partial basis for such an extrapolation.

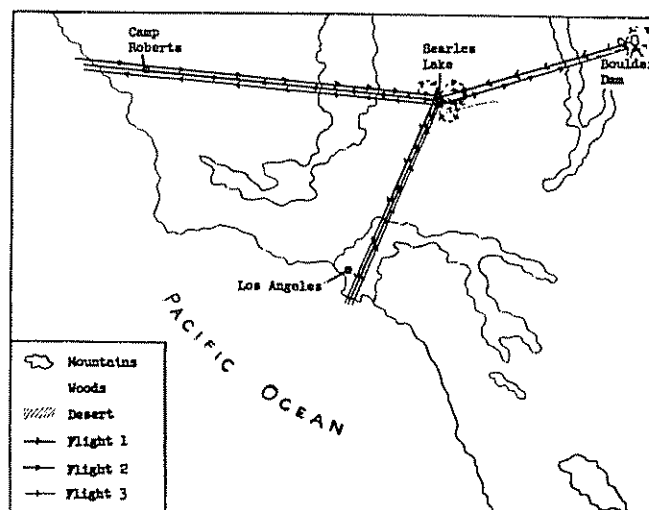

Figure 17. Investigation of Air-borne Profile Recorder: Flight line layout

As shown in figure 17, three separate flights were flown. Flight 1, at an altitude of 30,000 feet, started at Newport Beach in the south and passed over Searles Lake, where the radar equipment was turned off while the aircraft made a turn, as shown by the dotted lines. After recrossing Searles Lake, the flight then proceeded westward, passing over Camp Roberts and ending at the Pacific Ocean near Paso Robles, a total flight distance of 365 miles.

Flight 2 also was flown at an altitude of 30,000 feet. On this flight, however, the line began at Paso Robles and moved east to Searles Lake for the first leg. The aircraft again turned at Searles Lake, but this time headed east to Lake Meade. At Lake Meade the aircraft reversed its direction, recrossed the water surface and headed back to Searles Lake. The recrossing of Searles Lake was repeated and the last leg of the flight was from there to Newport Beach. The entire flight covered a distance of 675 miles.

Flight 3, flown at an altitude of 20,000 feet, covered the same flight path and direction as Flight 1

As shown in Figure 18, the equipment, installed in a B17-type aircraft, consisted of an Electronics Associates Limited model NBA-2, type A, radar altimeter. The profile recorder and the timing console and receiver were mounted on a table in front of the APR operator. A

Leeds Northrop recorder, with three recording pens, was used for the recording operation. Two of the pens recorded the corrected and uncorrected clearances, a third pen,

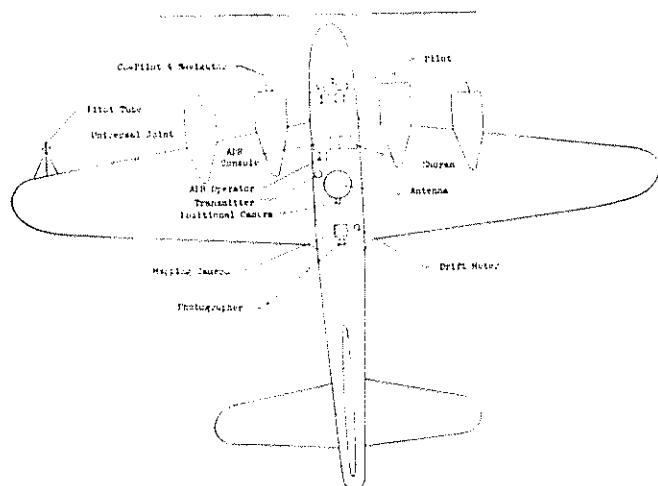

Figure 18. Aircraft equipped with Air-borne Profile Recorder

in the margin, the exposure interval of the 35-mm positional camera.

The parabolic antenna was rigidly mounted, as shown, to the aircraft frame. Stabilization was not incorporated in this installation; the antenna, however, was mounted so that the pitch attitude could be manually changed to compensate for changes in the gas load of the aircraft.

The static pressure was taken from a point assumed to be least affected by the turbulence produced by the aircraft. The pitot head was mounted on a universal joint especially designed to permit constant orientations in the slipstream. To stay as far away as possible from the turbulence of the aircraft, the pitot head was mounted, as shown, on a projection approximately three feet in front of the leading edge of the left wing.

A positioning camera was mounted rigidly to the antenna. The camera used was a 35-mm, $\frac{3}{4}$ -frame, movie-type camera which has a two-inch focal length and a 400-foot magazine capacity. The exposure interval of this camera was keyed to that of the vertical mapping camera by a special inter-valometer designed to fire the 35-mm camera five times at evenly spaced intervals between each mapping camera exposure.

Although the radar altimeter used employed the aneroid-type height corrector, a hypsometer-type corrector also was connected to the static source. Data from the hypsometer-type height corrector were recorded simultaneously with the aneroid recordings for the purpose of comparing the capabilities of the two instruments.

The evaluation of the air-borne data was divided into two phases. Phase 1 consisted of data reduction or, in other words, the isobaric slope, closure and calibration computations. Phase 2 included the application of the air-borne clearance data to photogrammetric triangulation techniques and an evaluation of the final accuracies and methods.

Photography for the final flight was procured on 29 November 1958; data reduction was started immediately. Each flight was referenced initially to sea level

at either end and no intermediate control was used to supplement the isobaric slope determination. Each profile was adjusted for isobaric slope according to formulas developed by T. J. G. Henry, Meteorological Division, Department of Transport of Canada. The only restriction to the radar data was that each flight closure, in feet, be within 45 per cent of the distance in miles. All the flights closed well within this figure.

The radar profile along the flight was evaluated by the comparison of the 35-mm positional points with the elevations determined by photogrammetric triangulation. An example of one such comparison is shown in figure 19. At the top of the figure is a reduction of the actual profile of Flight 3, flown at 20,000 feet, as recorded by the radar instrument. Directly below is the distribution of the errors of each 35-mm positional point along the profile determined by stereotriangulation using geodetic ground control. It can be seen readily that the profile is much less reliable in the mountainous terrain. This graph represents only one-half of the entire flight. The mean error in elevation of all the points on the flight was 22.1 feet. A similar evaluation of all the remaining flights indicates that APR is capable of tracing the profile of the ground with an average error of 12.4 feet over extremely long flight lines—averaging 17.3 feet in mountainous terrain and 10.3 feet in flat terrain.

The APR data were applied to the stereotriangulation exercise using two methods. One method, developed by the National Research Council in Ottawa, Canada, consists of selecting one APR elevation for each stereo pair and computing from the APR data the deviations of the aircraft altitude at each mapping camera exposure station (BZ). After orienting the initial model to geodetic control, the successive model is oriented to the first by pre-setting the known BZ and eliminating the parallax by using tip (θ). The scale of the succeeding model is set to the selected APR point, and height differences at the model connexion are recorded. This procedure is followed throughout the remainder of the strip. The final, adjusted elevations result from a correction curve that is plotted from the recorded height differences and $\Delta\theta$ s at each camera station. The other method of application of the APR data is similar to the procedures normally used at AMS with geodetic ground control. In this method the initial model is oriented relatively and set to an approximated scale. After "tipping up" the first model to allow for the usual fall-off of the strip, each model is oriented successively to the previously dropped, carry-over points. The resulting instrument co-ordinates for each positioning-camera-exposure centre are then adjusted to a best smooth curve fit of the APR-determined elevations of these points. A graphical curve of the correction to be applied to the instrument elevations of the strip along the APR axis results.

The accuracies of the APR-adjusted strips were decided by comparing the elevations of each of the positioning

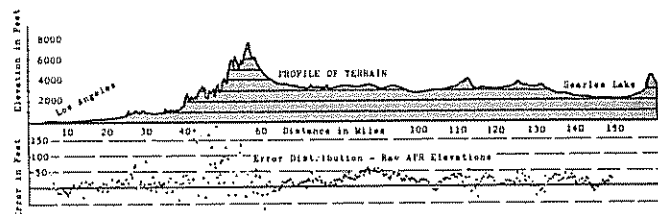

Figure 19. Comparison of radar profile with profile of terrain

camera stations as determined by this latter method with the elevations of the same points as determined by stereotriangulation using geodetic control. A summary of the resulting accuracies is shown in table 1.

Flight number	Leg ^a	Length (miles)	Flight altitude (feet)	RMSE
1	1	150	30,000	9.2
1	2	215	30,000	14.2
2	2	215	30,000	19.8
2	3	150	30,000	11.3
2	3 (return)	150	30,000	10.5
2	1	150	30,000	10.3
3	1	150	20,000	19.9
3	2	215	20,000	23.8

^a Leg 1: Newport Beach to Searles Lake; Leg 2: Searles Lake to Paso Robles; Leg 3: Searles Lake to Lake Mead

Initially, it was planned to adjust the APR flights to sea level only at each end. No intermediate geodetic points were to be used so that the datum of Searles Lake and Lake Mead would be determined by cantilever extension of APR alone. On Flight 2 the datum erred by only ten feet at Searles Lake and four feet at Lake Mead. On Flight 3 the errors at Searles Lake were distributed randomly; their mean indicated no datum error. Flight 1, however, showed a datum error of thirty-one feet. Because of the presence of this error, all flights were adjusted to the control at Searles Lake. The RMSEs listed in table 1 are based on sea level datum at the ends of the flight and on control at Searles Lake.

From figure 19 one can see that APR elevations over rough terrain become less reliable. The largest source of error lies in the identification of the APR point being used. The magnitudes of these errors were very evident during the adjustment of the stereotriangulated strips since graphical methods were used. As a result, the residual errors of the adjusted strips were greater in the mountainous terrain where the adjustment curve was not explicit. To provide greater control of the adjustment

curve in mountainous areas, stereo pairs in five model intervals were selected. The selected models were re-set in the stereoplanigraph C8 to the unadjusted passpoints "dropped" during the triangulation phase. The profiles between positional photo centres then were drawn with a vertical exaggeration of 5:1. The "Z" values indicated on the instrument for prominent points (hilltops and valleys) along the profile were recorded. The instrument profiles were re-drawn then to fit the horizontal and vertical scales of the APR-profile graph. A visual "best-fit" was made by superimposing one profile on the other. The corrections to be applied to the APR elevations of the prominent points were determined by scaling the distance between the two graphs. This procedure improved the final results in the mountainous terrain.

Because the flight lines were of such great length, several of the strips were broken for instrumentation. Two segments were connected by overlapping five exposures. All breaks were made in relatively flat terrain, with the exception of Leg 2 of Flight 2, which was broken in the mountains. Again, because of the unreliability of APR in mountainous terrain, the residual errors were large along the connexion area. This error, which could have been reduced by applying the techniques described in the preceding paragraph, however, was not detected until after the instrument phase had been completed. Therefore, the errors for that flight are reflected in the RMSE listed in table 1.

The more important conclusions which can be drawn from this study follow:

1. Air-borne Profile Recorder data can be applied to the stereotriangulation of strips up to 215 miles long with an expected RMSE of ten feet in flat terrain, twenty feet in mountainous terrain;

2. For the reliable application of APR data the profiles should be adjusted using Henry's formula. For optimum results the profiles should be flown in straight line patterns only and should begin and terminate over geodetic control;

3. APR data can be improved in mountainous terrain by fitting the radar profile to a photogrammetric-model surface

PORTABLE SURVEYING TOWER

Background paper by the United States Geological Survey

Lightweight portable towers for use in control survey operations have been developed by engineers of the Geological Survey. These towers are triangular in cross section, are made of tubular aluminium, and consist of an inner and outer tower. The weight of each tower is approximately five pounds per foot of height. The height of the tower may be varied from ten to seventy-six feet in six-foot increments. Assembled towers can be transported as a trailer or by helicopter.

The three legs of the outer tower are connected by horizontal members at six-foot intervals. Each section of the tower defined by two of the legs and two horizontal members is cross braced by one-eighth-inch aircraft cable under tension. This design affords a maximum strength-weight ratio. The inner tower is of similar construction, except for the bracing. Each section of the inner tower is braced with a diagonal tube that serves as both a tension and a compression member. This bracing affords the stability and rigidity required of the inner tower.

When transported trailer-fashion, the tower itself serves as the trailer. Trailer wheels attached to the outer tower may remain in place when the tower is erected. For short moves between stations, where roads permit, the tower should be towed to the field station fully assembled. A two-man team can erect an assembled fifty-two-foot tower in approximately one hour. For this height, the outer tower is guyed in four directions from points forty-five feet above the ground. Two of the guys are anchored in line with the axis of the erection hinge. The tower is erected by means of a small hand winch and a sixteen-foot raising boom. For safety, three additional guys are connected to the tower at points thirty feet above the ground. For long moves, the tower can be towed as a twenty-four-foot trailer, or it can be completely disassembled and transported by pickup truck.

For transportation by helicopter, the wheels are removed from the tower, and a leadline is installed. The leadline consists of a rope looped through the centre of the inner

tower and around the outer tower. The loop is arranged so that the tower can be connected to the lift cable of the helicopter by a man on the ground. Upon arrival at the desired location, the helicopter lowers the tower, and a ground party attaches temporary guys. When a fifty-two-foot tower is positioned as desired over a station, three safety guys are connected at points thirty feet above the ground.

The legs of the tower, adjustable for height, rest on aluminium footplates. No concrete footings are needed. The tower is sturdy enough to meet requirements of a wide range of surveying operations employing theodolites, signal lights and electronic distance measuring instruments. However, for triangulation, the most critical operation, further tests in the near future are planned to determine the effects of tower height and wind velocity.

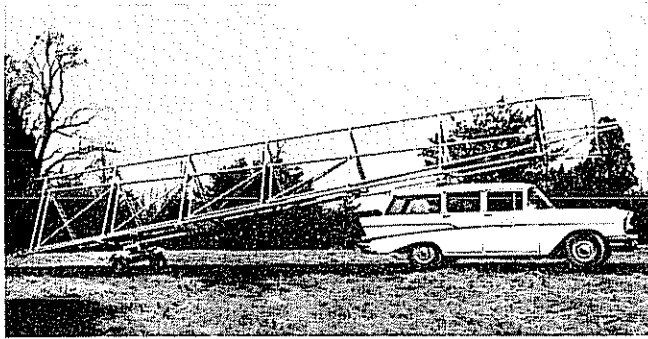

Figure 20. Portable surveying tower being towed as a trailer

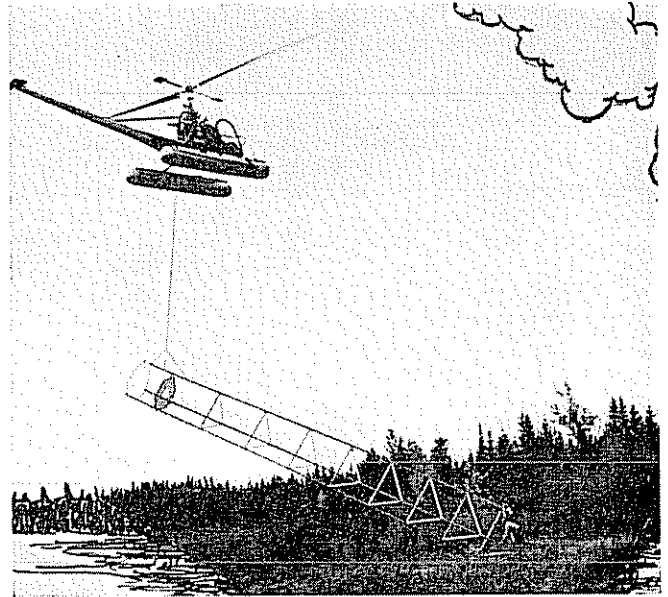

Figure 22. Portable surveying tower being transported by helicopter

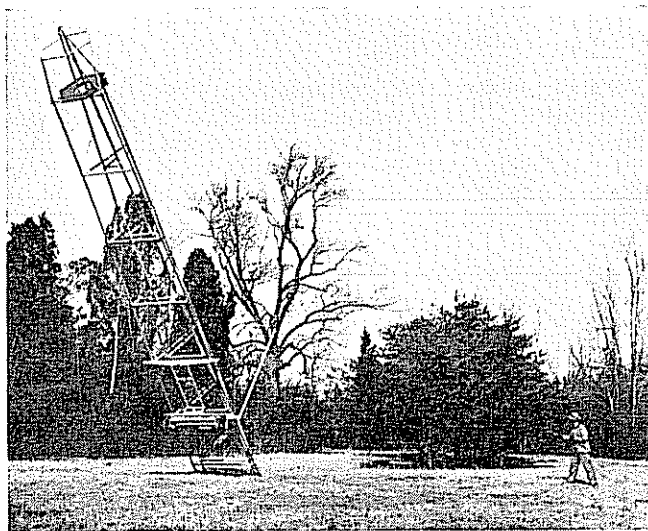

Figure 21. Erecting portable surveying tower

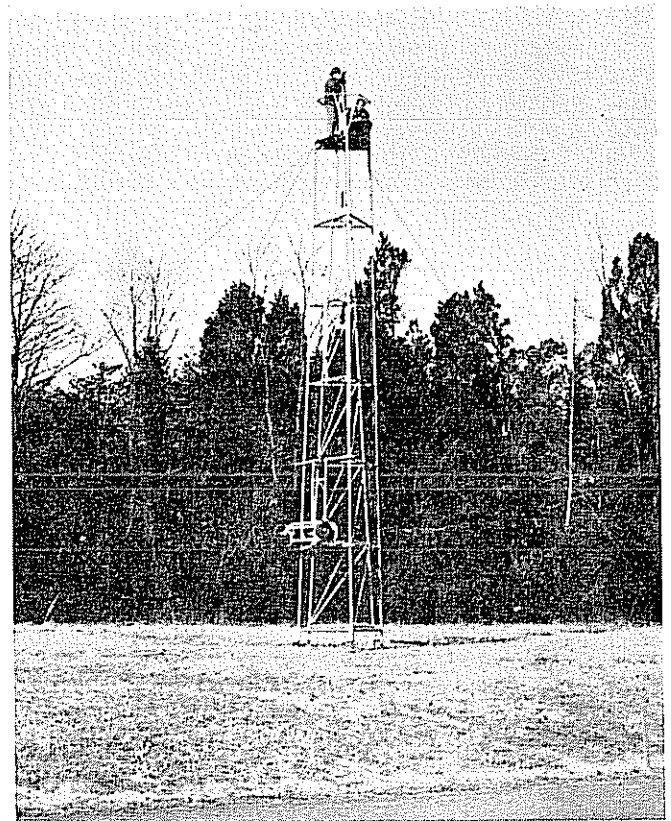

Figure 23. Fieldmen using theodolite on portable tower

FLASHING SIGNAL LAMP

Background paper by the United States Geological Survey

A flashing signal lamp has been developed recently by the Geological Survey for use in field surveying operations. The signal lamp has a low electric power consumption, a long-life bulb, an adjustable flash interval and is light in weight. This signal lamp, which provides a readily identifiable target, fills a need that has increased since the introduction of distance measuring operations by tellurometer and other similar electronic devices.

It has been established that pointings made on lights, either in daylight or darkness, are more accurate than those made on other types of signals. Heliotropes are recognized as excellent signal targets; however, they require constant attention and their use must be restricted to sunny days. Generally, the best source of light for a target is an electric lantern. When furnished with fresh bulbs and batteries, electric lanterns may be left unattended for hours at a time. Their operating cost is no more than a few cents an hour.

The base of the flashing signal lamp (see figure 24) is threaded to fit a universal tripod. A later model of this



Figure 24. Flashing signal lamp

device, similar to the one shown, has a protective cover for the sides and top. The top of this second model is threaded to permit two or more lamps to be placed one on top of the other. This arrangement is advantageous where two or more lamps must be aimed in different directions at the same time, for nearly simultaneous angle observations by two or more observing parties.

In addition to simplifying the problem of distinguishing this signal from other lights that may be visible to the observer, the flashing light makes the target easier to find under almost all unfavourable observing conditions. With a six-volt, 0.5-ampere bulb, the signal light is normally visible from a distance of fifteen kilometres. If the signal is left unattended for a number of days, the lamp can be adjusted to lengthen the time intervals between flashes. Although a long flash interval is a minor incon-

venience to the observer, the life of the battery is increased substantially. The use of a miniaturized transistor circuit adds to the life of the bulb by eliminating the surge of electric current that is characteristic of mechanical switching systems.

The diagram in figure 25 indicates the arrangement of components of a typical flasher circuit used with these lights. When the potentiometer R_1 is adjusted to permit the base of transistor T_1 to receive a small positive voltage

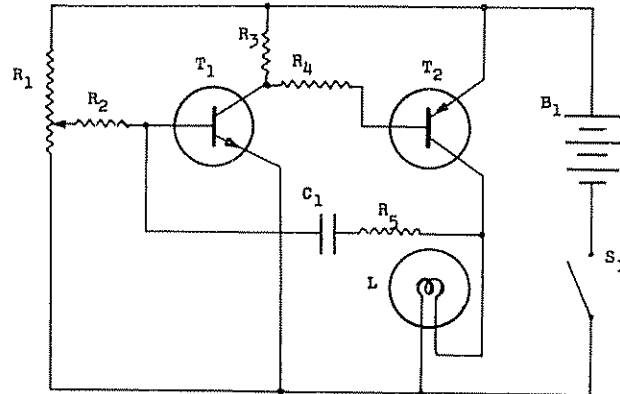

R_1	10,000-ohm Pot.	C_1	25 MFD 6-volt
R_2	6,800 ohm 1/2-watt	T_1	2N229
R_3	1,000 ohm 1/2-watt	T_2	2N307
R_4	270 ohm 1/2-watt	L	.5A, 6 v, (PR12 or PR13)
R_5	1,800 ohm 1/2-watt	B_1	6 v P4H, TW1, etc.

Figure 25. Flasher circuit diagram

so that T_1 conducts slightly, the current through resistors R_3 and R_4 increases. This also increases the current through T_2 and L and the voltage across L . The positive voltage on the base of T_1 increases because the lamp circuit is coupled to the base of T_1 through C_1 and R_5 . As a result of the feedback, the collector currents of T_1 and T_2 increase to a maximum, at which point nearly all the battery voltage is across L .

While the current flows through L , C_1 charges until the feedback current supplied to the base of T_1 is sufficient to hold T_1 and T_2 at minimum resistance; the voltage across L then begins to decrease. The base current of T_1 also decreases, causing a further decrease in voltage across lamp L . This results in a rapid decrease in the current of T_2 and likewise the lamp current.

The base of T_1 is driven to a negative voltage by reversed current flow through C_1 resulting from the charge accumulated on C_1 during the interval the lamp burned. Both transistors T_1 and T_2 are now cut off. The charge remaining on C_1 leaks off through R_2 , R_1 and R_5 . When C_1 is discharged, the base voltage of T_1 rises toward a positive value, determined by the setting of R_1 . As soon as the base of T_1 becomes slightly positive, T_1 starts to conduct and the cycle repeats.

Through adjustment of the setting of R_1 , the time cycle of the flashing lamp can be accurately controlled and held constant for weeks with a constant battery voltage. By counting the number of flashes per minute, the observer can identify the signal with certainty.

USE OF TELLUROMETER FOR CALIBRATION OF ELECTRONIC NAVIGATION AIDS

Background paper by the United States Navy Hydrographic Office

For the past several years, HYDRO has used range/range systems of electronic navigation aids to control hydrographic and bathymetric surveys. Specifically, such systems as two-range Decca and Lambda have been employed. Such systems, however, must be calibrated before operations commence to remove the fixed errors inherent in each pattern. To eliminate these errors, a line distance must be measured from the electrical centre of a slave station to the electrical centre aboard the ship. Until the past two years, this has been done optically; that is, three theodolites were set up over known points on shore and a series of angles was measured to the ship. This procedure required about one hour for each ship position calibrated. Since a minimum of four ship positions were used, and often six, it can be seen that it required one day just to observe angles; computing the raw data and adjusting required, normally, forty-eight hours more. Therefore, to calibrate one ship at both slave stations would use four to six days.

To eliminate this excessive use of non-productive time, it was necessary to develop another method of calibration. After some consideration, it was decided to try measuring the line distance by tellurometer. This method has worked very satisfactorily and, in addition to the elapsed time saved, it also was possible to reduce the number of men in the calibration party from four to two. There are also

other advantages: calibration can be carried on in fog or haze that precludes visual work; also, the system can be calibrated with the vessel farther at sea which reduces inaccuracies from the induction field.

To calibrate these navigational aids with tellurometer, new techniques needed to be developed. First, since distances need be measured only to the nearest metre, just the coarse readings are observed. To compensate for any movement of the vessel during observation the $A +$ crystal may be read twice. It is normally read first and a second reading can be made after the D crystal is read. Any difference between the two $A +$ crystal readings is then pro-rated throughout the series of readings. Secondly, meteorological readings need be taken on one end of the line only or, in fact, can be disregarded altogether. While there is a considerable saving in time during the period of observation, the real saving is effected when the true distance is computed. Instead of the cumbersome computations necessary before, the tellurometer system makes use of a table which converts milli-microseconds directly to metres. From metres, it is a simple matter to compute the Decca lanes. It is also possible to set up a table which would convert directly from milli-microseconds to lanes; however, a different table would have to be computed for each frequency.

TELLUROMETER FOR CONTROL SURVEY

Background paper by the United States Navy Hydrographic Office

Use of the tellurometer has enabled the Hydrographic Office to evolve new techniques as well as to make expanded use of old techniques for extending geodetic control nets. It has become the common practice of this Office to position secondary control points by closed loop traverse, using the tellurometer to measure the distance. This technique has made it feasible to run a traverse of several miles in length more rapidly than the job could otherwise be done and approach the accuracy of triangulation. The ability to run extended traverses makes it possible economically to extend control through long narrow chains of islands where there is insufficient width to carry forward a chain of triangles.

The tellurometer has also been of great value in those areas of the world where bad weather hampers visual

observations. By using the tellurometer to run a traverse in an area of this type, the number of visual observations is drastically reduced. Therefore, the necessary optical observations can be made during the limited periods of clear weather, while the electronic measurements can be made in almost any kind of weather short of heavy rain or snow.

Another possible application of the instrument, although this Office has not yet used it, is trilateration in cases where it is impractical or impossible to measure angles optically. The new model MRA-2, in which each instrument can be used as either a master or a remote, makes trilateration an even more attractive technique in certain difficult situations.

MEASUREMENT OF SMALL MOVEMENTS IN THE EARTH'S CRUST¹

Background paper by Charles A. Whitten, Chief, Triangulation Branch, Division of Geodesy, United States Coast and Geodetic Survey

A basic problem and responsibility of the classical geodesist has been to determine the size and shape of the earth, using all scientific data and information at his command. The literature contains the results of many studies of this type that have been made during the past

¹ The original text of this paper, submitted by the United States of America, appeared as document E/CONF.36/L.33.

century. With the improvement of instruments and techniques, and particularly with the addition of observational data, later determinations have brought higher accuracy in the parameters being determined. With this increase in accuracy some insight has been obtained on variables which originally were assumed either non-existent or insignificant.

The slow movement of portions of the earth's crust presents a related problem of extreme interest. Scientists in other branches of geophysics are interested in the causes of such movement and, on occasion, the effects. These scientists have sought the co-operation of geodesists in determining the magnitude of such movements and, if possible, the rate

Occasionally there will be a sudden displacement of the surface of the earth after a major earthquake or from earth slides or settling because of the activities of man, as he has either changed the topographic features on the surface or has extracted material from below the surface. Within this discussion, I shall review the programme of the United States Coast and Geodetic Survey with respect to the measurement of horizontal movement in areas of seismic activity.

The first large-scale effort in the United States to use geodetic techniques for measuring horizontal displacement was after the San Francisco 1906 earthquake. Extensive studies and resurveys were made in the years following that earthquake and the results have been the basis of frequent reference. Displacements of more than six metres along the fault line were reported.

During the period between 1920 and 1930, the first steps toward the development of a systematic programme of reobserving triangulation networks were initiated at the request of Dr. Arthur L. Day, Director of the Geophysical Laboratory of the Carnegie Institute, Chairman of the Committee on Seismology of that institution, and a colleague of Dr. William Bowie, Chief of the Division of Geodesy in the Coast and Geodetic Survey. The first project was the remeasurement of the primary scheme of triangulation along the coast of California, extending from San Francisco to the Imperial Valley. This scheme either straddled or was parallel to the San Andreas Fault from the Mexican border to the point at which the fault line enters the Pacific Ocean. The figures in this scheme of triangulation were large, with an average length of a side of about fifty kilometres with many lines longer than 100 kilometres and a few exceeding 150 kilometres.

The results obtained by reobservation of the directions over lines of this length will show major shifts but cannot be conclusive with respect to small movements. It was evident that, for the best results, measurements must be made between points more closely spaced and that these should form special configurations within the fault zone or across the actual fault lines, when these features could be identified on the surface. During the period between 1930 and 1940, several of these special pattern surveys were established along the San Andreas Fault and in the years since then these surveys have been repeated at approximately ten-year intervals. The appendix to this paper contains a listing of the survey projects including the dates of prior surveys and the dates of scheduled resurveys. A chart showing the general location of most of the projects is also included in the appendix. The design of the networks took advantage of the characteristic movement along horizontal and right lateral faults such as the San Andreas. Whenever an earthquake would occur and there was evidence of a major displacement, the programme or schedule would be broken and the resurvey in the area of the quake would be made as soon as possible after the quake.

The results of many of these resurveys have been published in different scientific journals and technical reports.

The measurements have consistently confirmed the slow creeping movement of one side of the fault zone with respect to the other. In determining the rate of this slow movement, one must consider the validity and stability of reference points, the width of the zone to which the rate would apply, and the geographical location along the 1,000-kilometre extent of the fault line in California. The average rate of movement as determined during the past thirty years is three centimetres per year across a fault zone thirty kilometres wide, the western side moving north with respect to the eastern side or, inasmuch as the absolute cannot be determined, the eastern side moving south with respect to the western side.

Mathematical techniques have been developed to give an indication of the amount of deformation taking place in the crust prior to the release of the strain at the time of an earthquake. We can assume that any small rectangular area near the fault (with a side parallel to the fault) will be deformed into a parallelogram by the forces within the earth's crust. By comparing lists of directions at a point within such an area, the amount or rate of deformation can be determined. The computed horizontal angular rate of deformation for areas near the San Andreas Fault is about one second of arc per ten years. Other modifications to the basic programme have included the use of electronic distance measuring devices, measurement over very closely spaced monuments not connected to the national geodetic network yet straddling a known fault line, and the reobservation of astronomic azimuths of lines perpendicular to and crossing the fault line. This latter technique has been used for individual confirmations of this slow movement and development of strain.

A unique situation exists at a winery near Hollister, California. The principal buildings used by this winery were constructed just a few years ago and by mere chance, attributed to real estate development rather than to scientific forethought, happened to be exactly on the San Andreas Fault. Building inspectors noticed unexplainable cracks and fractures developing in the walls and concrete slabs. Mr. Karl Steinbrugge of the Pacific Fire Rating Bureau began to collect what data he could from the structural changes. Later, Dr. Don Tocher, of the University of California at Berkeley, and Mr. Steinbrugge asked the Coast and Geodetic Survey to establish a set of monuments near these buildings which might be resurveyed periodically so that data could be obtained and the results compared. The unusual feature of this particular location is that there is frequent slipping along the fault line. These minute displacements are less than a millimetre at a time but occur so frequently and regularly that over a long period of time the rate seems to be quite uniform. Mr. Steinbrugge's measurements made over a period of forty-seven months between 1956 and 1960 indicated a slippage of 4.6 centimetres. Dr. Tocher, from a series of measurements between 1958 and 1960, obtained 2.8 centimetres in twenty-one months. In August 1957, the Coast and Geodetic Survey established two sets of four monuments each on opposite sides of the winery. One set of four monuments consisting of a quadrilateral about 300 metres square and the other set a traverse line perpendicular to and crossing the fault with marks about 200 metres apart. These configurations were resurveyed in April 1959, and for that twenty-month period the data from the quadrilateral showed a 2.2-centimetre displacement and from the traverse a 2.1-centimetre displacement. The measurements were repeated again in May 1960,

and during the preceding thirteen-month period the displacement in the quadrilateral was 2.1 centimetres and that on the traverse line, 1.7 centimetres. A rather sharp earthquake occurred near Hollister early in 1961. A resurvey of the special monuments in April 1961 showed an actual displacement in the quadrilateral of 1.9 centimetres and on the traverse line of 1.7 centimetres for the eleven-month period. All of these measurements showed a variation of about 1.5 millimetres per month. The resurveys of the larger networks in this same area confirm this slippage along the fault but show that the major slow creeping movement with a slightly higher rate is still taking place across the wider fault zone. Some, but not all, of the strain is being released by these small displacements at the fault line. It is hoped that similar configurations can be placed at other locations along the fault where it can be identified at the surface.

In 1932, a small network of closely spaced monuments was established in the vicinity of Taft and Maricopa, California. The extreme southern portion of this net crosses the San Andreas Fault and the northern part of the net covers an active oilfield known as the Buena Vista Hills area. There is a thrust fault underlying these hills. Engineers and geologists associated with oil companies have been concerned with the horizontal movement across this fault. Points on the surface on opposite sides of the fault have been moving toward each other at the rate of two or three centimetres per year. The original network of triangulation was reobserved in 1959. The extreme southern section was not of sufficient extent to detect any displacements along the San Andreas Fault but the data from the northern portion of the survey produced results which were in agreement with the measurements of the engineers and geologists across this thrust fault.

Figures 27 and 27A show the results. The vectors point toward the centre of the oilfield which extends east and west. The points showing a minimum movement, such as Extra, are near the centre of the oilfield. This entire region is known to have subsided because of the withdrawal of oil and it seems quite reasonable to attribute the horizontal movement to this same fact with the fault line merely providing a simple mechanism at the surface of the earth to accommodate the horizontal movement which always accompanies the vertical movement under such circumstances. Plans have been made to include releveing as a fundamental part of the future resurvey programme over these particular monuments.

Within recent years the Water Resources Board of California has taken an active part in supporting this programme. That Board is confronted with the problem of supplying water to the residents of southern California living on the western side of the San Andreas Fault from a source in northern California on the eastern side of the fault. Aqueducts to supply southern California must cross this fault line. The question, then, of selecting the most suitable place to cross this fault zone requires a vast accumulation of geodetic and geological information for its solution. Even after the locations have been selected the forces within the earth's crust will continue to produce changes, bringing added problems of maintenance to these water systems.

These studies of earth movement must continue. A period of thirty, fifty or even 100 years, is hardly adequate to portray, definitively, the nature or ultimate course in movements involving the earth's crust. Also, similar studies must be made in other regions and in other

countries where major blocks of the earth's crust are known to be moving with respect to each other. It is our responsibility in this generation to supply data which may be used by our successors in furthering the search for greater knowledge in this small but interesting phase of earth science.

REFERENCES

- Koch, Thomas W., 1933, "Analysis and effects of current movement on an active thrust fault in Buena Vista Hills oil field, Kern County, California", *Bull. Am. Assoc. Petr. Geol.*, 17:694-712.
- Lawson, A. C., et al., 1908, *The California Earthquake of April 18, 1906: Report of the State Earthquake Investigation Commission* (Washington, D. C., Carnegie Institution of Washington, 2 vols. plus atlas).
- Steinbrugge, Karl V., 1957, *Building Damage on the San Andreas Fault*, report dated 18 February 1957, published by the Pacific Fire Rating Bureau for private circulation.
- Steinbrugge, Karl V., Tocher, Don, Whitten, C. A., et al., 1960, "Creep on the San Andreas Fault", *Bull. Seism. Soc. Am.*, 50:389-415.
- Whitten, C. A., 1948, "Horizontal earth movement, vicinity of San Francisco, California", *Trans. Am. Geophys. Union*, 29:318-323; 1949, "Horizontal earth movement in California", *Journal of the Coast and Geodetic Survey*, April 1949 (1949, No. 2), pp 84-88; 1955, "Measurements of earth movements in California", in *California Division of Mines, Bulletin 171*, pp. 75-80; 1956, "Crustal movement in California and Nevada", *Trans. Am. Geophys. Union*, 37:393-398; 1960, "Horizontal movement in the earth's crust", *Journal of Geophysical Research*, 65:2839-2844.
- Wilt, James W., 1958, "Measured movement along the surface trace of an active thrust fault in the Buena Vista Hills, Kern County, California", *Bull. Seism. Soc. Am.*, 48:169-176.

APPENDIX

PROGRAMME FOR REPEATING TRIANGULATION NETS

Project	Scheduled survey	Previous surveys
Monterey Bay	1961	1930, 1951
San Luis Obispo North-eastward		1932, 1951
Across Hayward Fault East to Mt Lola	1962	1952, 1957
San Fernando to Bakersfield		1932, 1952, 1953
Newport Beach to Bear Lake	1963	1929, 1934, 1953
El Centro	1964	1935, 1941, 1954
Water resources, Taft-Mojave Area	1965	1959, 1960
Primary Scheme Southern California	1966	1910, 1924, 1955
Dixie Valley, Nevada		1954, 1955
Coastal Scheme, first order	1967	1880, 1923, 1946, 1948, 1957 (part)
Olema		1907, 1948, 1957
Crystal Springs		1907, 1948, 1957
Hollister Winery		1957, 1959, 1960, 1961
Palmdale	1968	1938, 1947, 1958
Cajon Pass		1949
Maricopa	1969	1938, 1949, 1959
Taft		1932, 1959
Gorman		1938, 1949
Brea		1949
Whitewater	1970	1950
Moreno		1950
Pt. Reyes to Petaluma		1930, 1938, 1948 (part), 1960-1961
Owens Valley	1976	1935, 1956

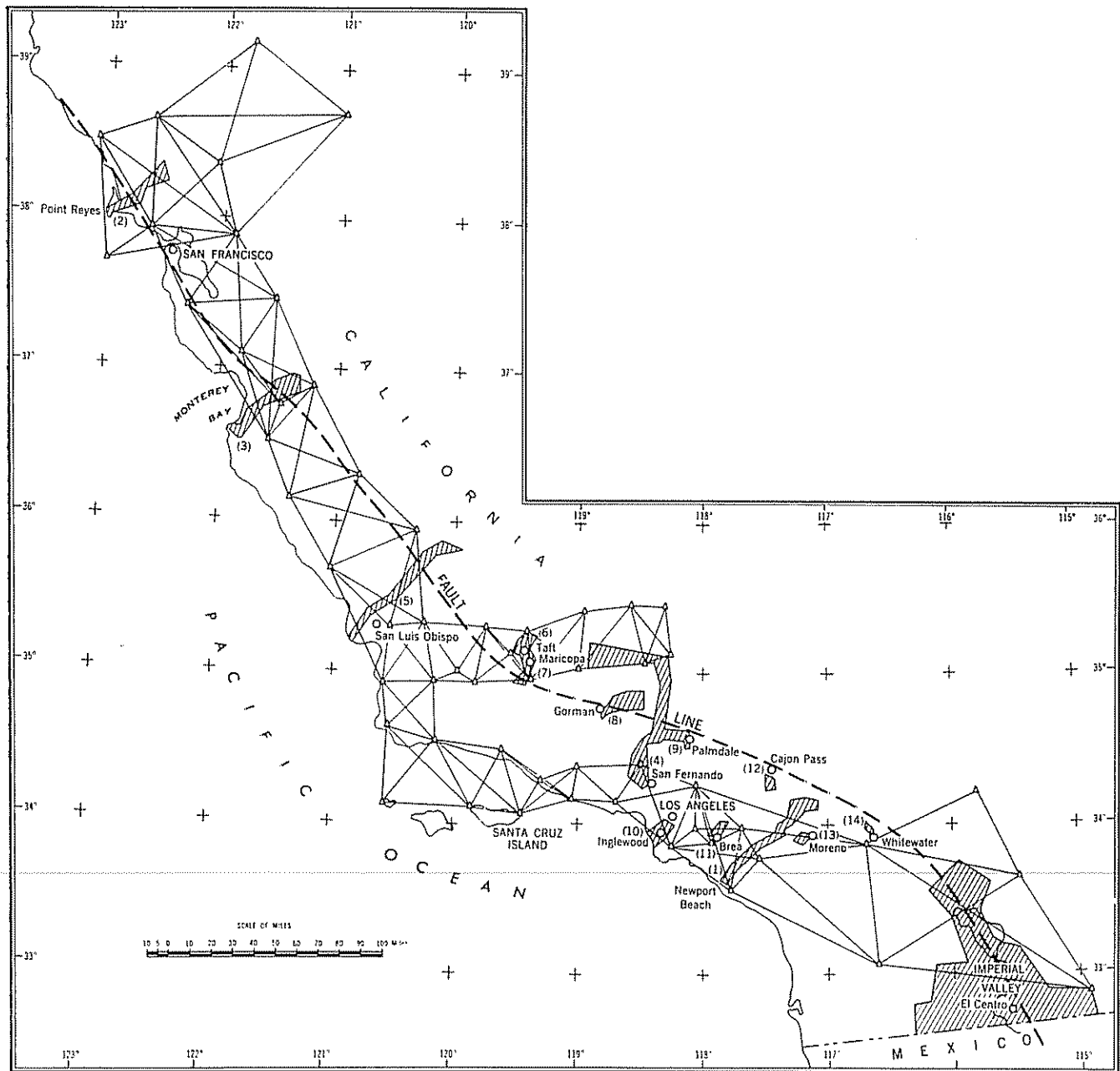

Figure 26. General location chart of earth movement projects

Hatched areas show survey projects across San Andreas Fault to determine crustal changes

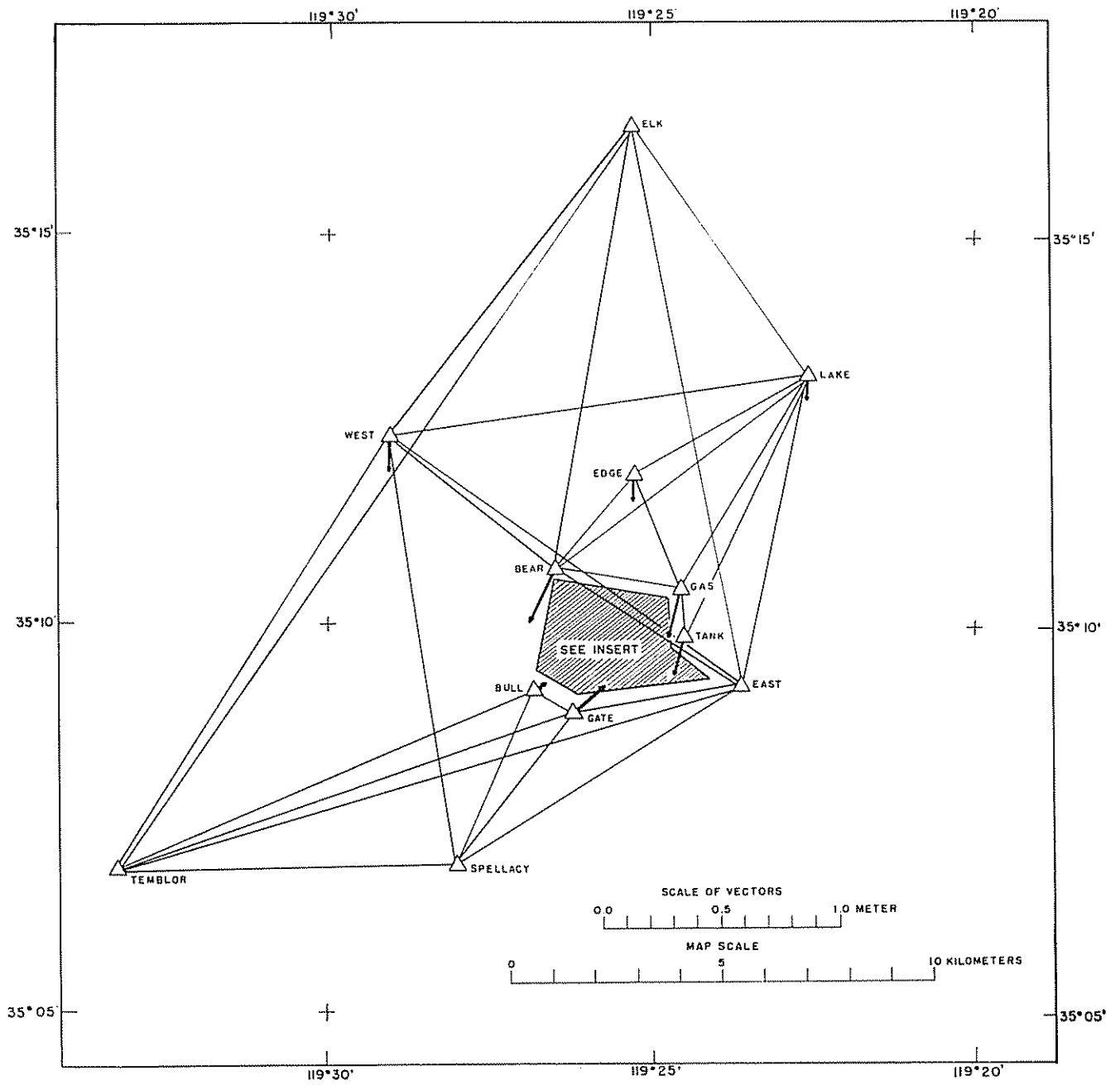

Figure 27. Horizontal movement of earth's crust between 1932 and 1959, vicinity of Buena Vista Hills, California

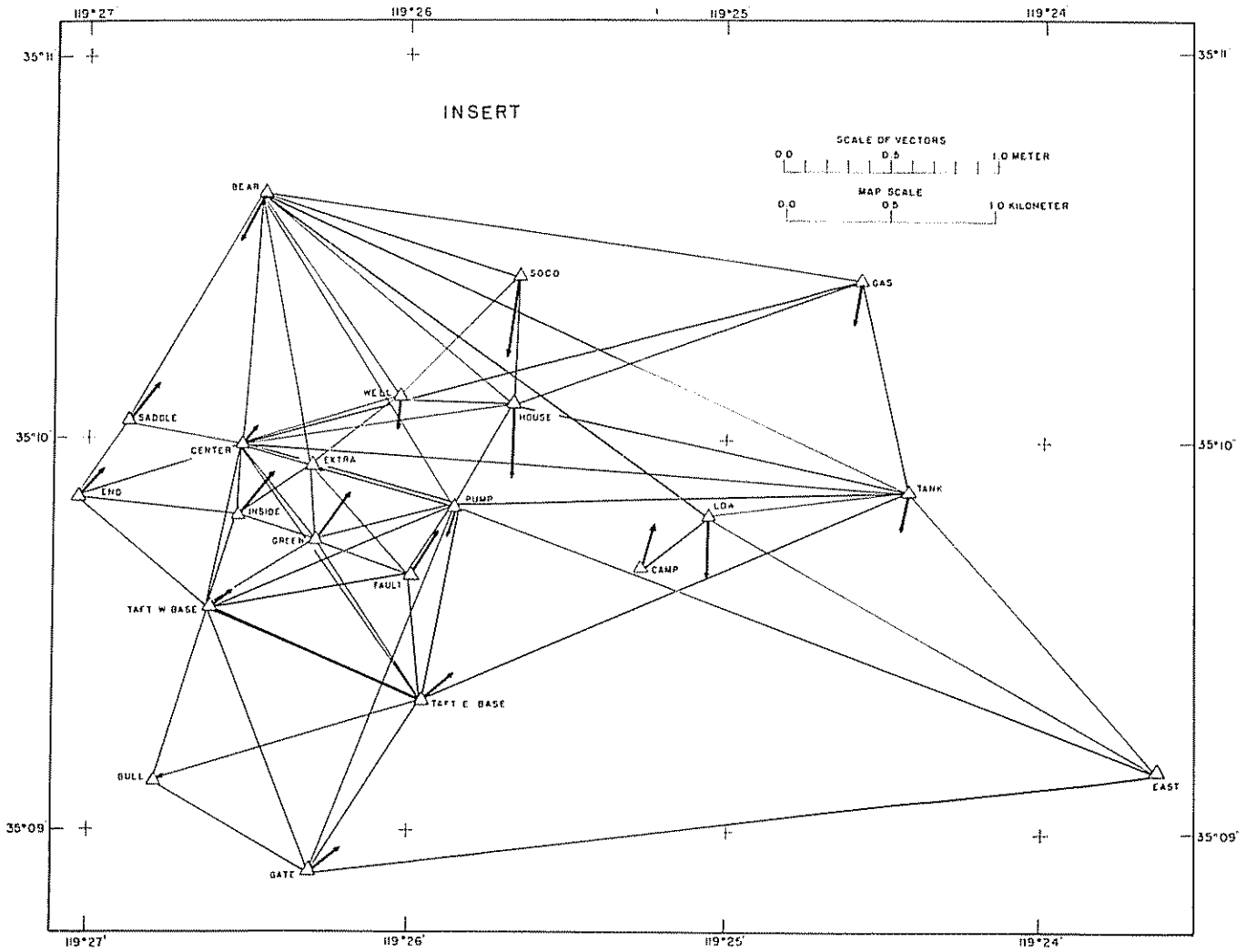

Figure 27A

THE ISOPARAMETRIC METHOD OF MAPPING ONE ELLIPSOID ON ANOTHER¹

Background paper by John A. O'Keefe, United States Army Map Service

ABSTRACT

Geodetic positions can be transferred from one ellipsoid to another by calculating x, y co-ordinates on some standard projection for the first ellipsoid, and then, regarding the x, y co-ordinates as identical on the two ellipsoids, reversing the computation using the constants and tables appropriate to the second ellipsoid. It is shown that the distortions introduced in this way are proportional to the distortions of the projection used for calculating the x, y co-ordinates, and that the ratio of proportionality is equal to the fractional change in the Gaussian curvatures.

In transferring geodetic positions from one ellipsoid to another, many mathematicians in the Corps of Engineers, United States Army, make use of a quite simple and direct procedure. In the course of discussions with European geodesists, this procedure has been questioned, and the lack of an adequate theoretical explanation for it has been pointed out. This paper is an attempt to supply the required explanation.

Let us suppose that we are given a set of latitudes, ϕ , and longitudes, λ , in the area G . These have been calculated from the original measurements of angles and distances by means of tables for the spheroid A , starting from the datum point, whose latitude and longitude, ϕ_0, λ_0 , result from astronomic measurements at one or more stations. It is desired to convert all the latitudes and longitudes to those latitudes and longitudes which would have been obtained if the spheroid B had been chosen instead. The first step is to calculate co-ordinates which we may designate as u^1 (northing) and u^2 (easting), based on some standard projection, such as the transverse Mercator, and referred to spheroid A by the use of the appropriate tables. The superscripts on u^1, u^2 merely distinguish the co-ordinates; to indicate the squares, we shall write $(u^1)^2, (du^1)^2$ and the like. The origin is taken at the point ϕ_0, λ_0 which should usually be near ϕ_1, λ_1 , since this is the point whose latitude and longitude will be unchanged. The projection is chosen with an eye to obtaining a cartographically satisfactory representation of the area; that is, the axis of strength, along which the derivatives of the scale factor are zero, is made to coincide with the long axis of G , so far as convenient.

Next, the values of u^1, u^2 are converted back to latitude and longitude, using, this time, tables for the same projection, but referred to the new spheroid, B , with the origin still at ϕ_0, λ_0 . This procedure may be called the isoparametric procedure since the parameters u^1, u^2 are the same on both spheroids.

Evidently the procedure is not utterly unreasonable. When the points from spheroid A are converted to rectangular co-ordinates u^1, u^2 , it is almost as though they had been expressed in terms of the original measurements in distance and angle on the ground. Near the origin, in particular, and especially for short lines, the ground measurements can be obtained from the co-ordinates immediately, with a very fair degree of accuracy, without any special assumption about the spheroid. It is, in fact,

an operational procedure in many places, for example, Sweden and Madagascar, to pass directly from ground measurements to rectangular co-ordinates, even in first-order triangulation, by means of formulas so constructed that the role of the assumed spheroid is a very small one, indeed. In this sense, one can almost say that the rectangular co-ordinates do not presuppose any spheroid. We put in the elements of the spheroid when we pass through tables based on B to latitudes and longitudes.

The crucial step in the isoparametric method is the one in which, from regarding the rectangular co-ordinates as being co-ordinates on A , we change to regarding the identical numbers as co-ordinates on B . If this step is justified, then all the rest is pure routine. There is no doubt, for example, about the possibility of transforming latitudes and longitudes on A into rectangular co-ordinates on a grid whose mathematics are adequately known. The resulting co-ordinates will be free from ambiguity, and will represent exactly the same positional relationship among the points. Nor is there any difficulty about transforming rectangular co-ordinates on spheroid B into latitudes and longitudes on B . The problem comes at the step when we decide that we shall consider the rectangular co-ordinates which we have worked out on A as belonging on B also.

There will be some distortions of the original data at this step. For example, on the transverse Mercator projection the scale, m , that is, the ratio of distance on the projection to ground distance, is given approximately by

$$m = 1 + \frac{(u^2)^2}{2\rho\nu} \dots \dots \dots (1)$$

where u^2 is the easting reckoned from the central meridian, and ρ, ν are respectively the radii of curvature in the meridian and perpendicular to the meridian. If we change to a new spheroid, keeping u^1 and u^2 identical numbers, then evidently we will change m , because the product $\rho\nu$ has changed. Obviously, also, the change will be small. Good cartographic practice requires that $m-1$, the map distortion, be kept, if possible, below paper shrinkage, that is, less than 0.1 per cent. The change in $\rho\nu$ in passing from one spheroid to another is not likely to exceed 1:5,000; hence, the change of m is not likely to be more than 1:5,000,000. Such a scale change has no significance whatever for field measurements; the best of these do not appear to be much better than 1:1,000,000. On the other hand, it can, of course, lead to misunderstandings in the computing room. It is therefore worth while to see exactly how this method compares with other methods for transforming co-ordinates.

Since we seek above all to eliminate misunderstandings and to carry conviction, it appears best to make use of mathematical language. Fortunately, the problem has been treated by the mathematicians in some detail. The eighth chapter of Levi-Civita (1926) discusses the relation between two different metrics assigned to the same analytical manifold; and this is mathematical language for our problem. The two different metrics can be conveniently thought of as two different surfaces, in our case the spheroids A and B , and the analytical manifold as the set of values of u^1, u^2 which are the same for the two spheroids. The footnotes at the beginning of his chapter make it

¹ The original text of this paper, submitted by the United States of America, appeared as document E/CONF 36/L 35.

clear that it is this sort of situation that Levi-Civita has in mind.

Levi-Civita proceeds to set up the fundamental quadratic forms in the two metrics (spheroids), which, if we employ the summation convention, and if we write the indices on the co-ordinates as superscripts, become

$$ds^2 = a_{ij} du^i du^j \quad (2)$$

$$(ds')^2 = a'_{ij} du^i du^j \quad (3)$$

where ds is an infinitesimal ground distance on the first spheroid; ds' the corresponding quantity on the second spheroid; i and j range from 1 to 2. For any conformal projection, (2) becomes

$$ds^2 = \frac{1}{m^2} \left[(du^1)^2 + (du^2)^2 \right] \quad (4)$$

the familiar relation for the scale factor, with m as the scale. For non-conformal projections the formulas are more complicated. If the rectangular co-ordinates are orthogonal on the ground, the scale factor for the u^1 direction is no longer the same at a given point as the scale factor in the u^2 direction; and if the co-ordinates are not orthogonal it will be necessary, in addition, to make use of a product term in du^1, du^2 . For example, on the azimuthal equidistant projection, we have up to terms of the second order in the a_{ij} by substitution from the table, page 392, of Chovitz (1952) into the Eq. (3), page 380, and thence into (1), page 380, bearing in mind Eq. (30), page 389

$$ds^2 = \left[1 - \frac{1}{3} K (u^2)^2 \right] (du^1)^2 + \frac{2}{3} K u^1 u^2 du^1 du^2 + \left[1 - \frac{1}{3} K (u^1)^2 \right] (du^2)^2 \quad (5)$$

where K is the Gaussian curvature, $1/\rho\nu$. These co-ordinates are identical with those sometimes called Riemann canonical co-ordinates (Blaschke, 1945).

The relation of the ds' to ds is clearly governed by the relation of the two fundamental tensors a_{ij} and a'_{ij} .

These tensors will also tell us, in the case of a non-conformal projection, the amount of angular distortion which has been introduced. If we consider the infinitesimal vectors $du^1, \delta u^1$, one along each side of an angle θ , then we can define the so-called parameters of the direction (not the same as the parameters u^1, u^2 which are unchanged by the transformation) as follows

$$\lambda^i = \frac{du^i}{ds}; \mu^j = \frac{\delta u^j}{\delta s} \quad (6)$$

where

$$\cos \theta = a_{ij} \lambda^i \mu^j \quad (7)$$

(Levi-Civita, 1926, page 93, Eq. (8)). The change of θ in passing from one ellipsoid to another arises in part from the change of a_{ij} , and in part from the change of λ^i, μ^j arising from the changes in ds and δs .

It is particularly interesting to examine the results of these procedures for the Helmert method of representing one ellipsoid upon another. It will be shown below that the Helmert method is equivalent to mapping by way of the azimuthal equidistant projection. For the moment, let us take this result for granted. Let us consider a point at a distance of 200 kilometres from the initial point, and let us ignore the variations of K with position on the given ellipsoid. Suppose that the origin of the system is at 45° latitude and that the co-ordinates of the point are $u^1 = 160$ kilometres, $u^2 = 120$ kilometres, and that $du^1 = -1$ metre and that $du^2 = +1$ metre. The computation of ds on the two spheroids is shown in table 1. It is based on (5).

Table 1.—Computation of ds , at latitude 45° N

Quantity	Bessel	International
ρ	6,366,676 metres	6,367,587 metres
ν	6,388,065 metres	6,389,135 metres
$K = 1/\rho\nu$	2.45877×10^{-14} (metres) ⁻²	2.45801×10^{-14} (metres) ⁻²
$(u^2)^2/3$		$+ 4.800\,000 \times 10^9$ (metres) ² ; $(du^1)^2 = +1$
$2(u^1u^2)/3$		$+ 12.800\,000 \times 10^9$ (metres) ² ; $(du^1 du^2) = -1$
$(u^1)^2/3$		$+ 8.533\,333 \times 10^9$ (metres) ² ; $(du^2)^2 = +1$
a_{ij}	$\left\{ \begin{array}{l} 1 - 4.800\,000 \times 10^9 K \\ + 6\,400\,000 \times 10^9 K \end{array} \right.$	$\left\{ \begin{array}{l} + 6\,400\,000 \times 10^9 K \\ 1 - 8.533\,333 \times 10^9 K \end{array} \right.$
ds^2	$2 - 26\,133\,333 \times 10^9 K$	
ds^2	1 999 357 441	1 999 357 640
ds	1.413 986 365	1 413 986 436
	$\frac{\text{International length}}{\text{Bessel length}} = 1 + 50 \times 10^{-9}$	

We next calculate the angle θ between this line, which we may call du^1 , and another line, δu^1 , whose components are $\delta u^1 = +1$ and $\delta u^2 = 0$. The length of the line δu^1 is given, by similar computations, as Bessel spheroid, 0.999 940 988 metres; International ellipsoid, 0.999 941 006 metres. The parameters of the direction, for the line du^1 , may be denoted as λ^1 ; those for the line δu^1 as μ^1 . Substituting the actual numbers in (6) on the Bessel spheroid, $\cos \theta = -0.707\,067\,368$; on the Inter-

national ellipsoid, $\cos \theta = -0.707\,067\,380$. Whence θ , International minus Bessel equals -0.0036 .

In these calculations, the effect of terms above the second order in the a_{ij} has been neglected. In consequence, the calculations of ds and $\cos \theta$ are not exact. On the other hand, the neglected terms are small, and the variations produced in them by the change of spheroid are smaller yet, by a factor of about 5,000; hence the ratio of the two

values of ds , and the difference of the values of 0 are accurate.

By these methods, it is possible to evaluate the errors which will be produced if the isoparametric method is applied, making use of any of the projections listed by Chovitz.

In order to have a more general view of the problem, we calculate the expression for the square of a length element in locally Cartesian co-ordinates. Since these are identical with true Cartesian co-ordinates up to terms of the second order in the a^i , we have, by a Taylor expansion

$$a_{ij} = \delta_{ij} + \frac{1}{2} \frac{\partial^2 a_{ij}}{\partial u^k \partial u^h} u^k u^h + \dots \quad (8)$$

$$ds^2 = \left(\delta_{ij} + \frac{1}{2} \frac{\partial^2 a_{ij}}{\partial u^k \partial u^h} u^k u^h \right) du^i du^j \quad (9)$$

For ordinary Cartesian co-ordinates, we would have

$$d\sigma^2 = \delta_{ij} du^i du^j \quad (10)$$

As a measure of the errors of the representation, it is convenient to take the quantity $ds^2 - d\sigma^2$ which we shall call. The actual "error in length" is $ds - d\sigma$. The relation between the two quantities is clearly given by

$$ds - d\sigma = \frac{ds^2 - d\sigma^2}{ds + d\sigma} = \frac{\epsilon}{2 d\sigma} \quad (11)$$

Subtracting (10) from (9)

$$\epsilon = \frac{1}{2} \frac{\partial^2 a_{ij}}{\partial u^k \partial u^h} u^k u^h du^i du^j \quad (12)$$

Chovitz (1952, Eq. 21), points out that in locally Cartesian co-ordinates we know that

$$2K = 2 \frac{\partial^2 a_{12}}{\partial u^1 \partial u^2} - \frac{\partial^2 a_{11}}{\partial u^2 \partial u^2} - \frac{\partial^2 a_{22}}{\partial u^1 \partial u^1} \quad (13)$$

This result can be immediately obtained from the formula of Gauss (1827, page 236) by reducing to locally Cartesian co-ordinates.

Since the errors of length are proportional to the second derivatives of the a_{ij} , it is evident that most cartographic projections will be so chosen as to make these second derivatives as small as can conveniently be done. It is also evident from (13) that not all the second derivatives can be made equal to zero; at least some of them must be of the order of magnitude of K . This is the underlying reason why the coefficients of K in Chovitz's table of projections are all of the order of unity.

Returning now to the original problem of mapping one ellipsoid on another, we can construct an equation similar to (12) for the new ellipsoid (quantities peculiar to the new ellipsoid being primed)

$$\epsilon' = \frac{1}{2} \frac{\partial^2 a'_{ij}}{\partial u'^k \partial u'^h} u'^k u'^h du'^i du'^j \quad (14)$$

The u'^k and u'^h , and the du'^i , du'^j are not primed because they are by hypothesis the same on both spheroids. The second derivatives of the a'_{ij} must satisfy an equation like (13), namely

$$2K' = 3 \frac{\partial^2 a'_{12}}{\partial u'^1 \partial u'^2} - \frac{\partial^2 a'_{11}}{\partial u'^2 \partial u'^2} - \frac{\partial^2 a'_{22}}{\partial u'^1 \partial u'^1} \quad (15)$$

Evidently the change in the square of the length of a very short line in passing from one ellipsoid to another by the isoparametric procedure is given by subtracting (12) from (14)

$$\epsilon' - \epsilon = \frac{1}{2} \left(\frac{\partial^2 a'_{ij}}{\partial u'^k \partial u'^h} - \frac{\partial^2 a_{ij}}{\partial u^k \partial u^h} \right) u^k u^h du^i du^j \quad (16)$$

In this equation, the differences of the second derivatives are subject to an equation analogous to (13), formed by subtracting (13) from (15), namely

$$2(K' - K) = 2 \frac{\partial^2}{\partial u'_1 \partial u'_2} (a'^{12} - a^{12}) - \frac{\partial^2}{\partial u'_2 \partial u'_2} (a'^{11} - a^{11}) - \frac{\partial^2}{\partial u'^1 \partial u'^1} (a'^{22} - a^{22}) \quad (17)$$

It is evident from (17) that unless the Gaussian curvatures of the two ellipsoids are equal, not all the differences of the second derivatives of the a_{ij} can be equal to zero. The analogy with the representation of the ellipsoid on the plane can be pushed even farther, for we see that at least some of the differences of the second derivatives must be of the order of magnitude of the difference of the Gaussian curvatures.

Now if a_{ij} and a'_{ij} correspond to any ordinary projection, we shall find that the second derivatives are proportional to the Gaussian curvatures. This result is implied by Chovitz (1952, pages 389 and 392), when he factors out the Gaussian curvature from all of his a^i_k , and finds purely numerical quotients. The result is purely empirical; it would not hold for the latitude and longitude system near the equator. In view of equations like (13), however, it is not reasonable to construct co-ordinate systems which lack this property. For the listed map projections, (16) can be written by the usual principles of proportion

$$\epsilon' - \epsilon = \frac{K' - K}{K} \frac{1}{2} \frac{\partial^2 a_{ij}}{\partial u^k \partial u^h} u^k u^h du^i du^j \quad (18)$$

or, substituting (12)

$$\epsilon' - \epsilon = \frac{K' - K}{K} \epsilon \quad (19)$$

and making use of (11)

$$ds' - ds = \frac{K' - K}{K} (ds - d\sigma) \quad (20)$$

Equation (20) asserts: If one ellipsoid is mapped upon the other by the isoparametric method, using the projection p as intermediary, then up to terms of the second order in the co-ordinates (the origin being on the axis of strength) the length distortions introduced on the second ellipsoid bear to the length distortions introduced between the first ellipsoid and p the same ratio as the difference of the Gaussian curvatures bears to the Gaussian curvature of the first ellipsoid.

It follows that we may gain insight into the length distortions which will be produced in mapping one ellipsoid on another by this process if we consider the well-known cartographic distortions which accompany the transfer from the ellipsoid to the plane. The distortions from one ellipsoid to another will be less than the cartographic distortions, in a ratio which is usually of the order of 1:10,000; but they will be similar in kind and similarly distributed.

In the case of an area which has been mapped on a single projection, it may not be necessary to alter the grid co-

ordinates in any way in order to convert from one ellipsoid to another. We may simply declare that the given co-ordinates are to be regarded as being on a new ellipsoid. (This may not be done, however, with the system of latitudes and longitudes because they are not locally Cartesian except at the equator and because for this system the a_{ij} involve the quantities ρ and ν , as well as K .) If the projection was devised by a competent cartographer, it is evident that the cartographic distortions will have been minimized throughout the area; it is thus automatically the most advantageous type of projection to use in transferring data from one ellipsoid to another. In a sense, one can say that the grid co-ordinates are independent of the assumed spheroid, at least up to terms of the third order in the co-ordinates.

In other cases, it may be inexpedient to make use of the projection given for the original grid co-ordinates. At such times, the co-ordinates of the original grid may be converted to a new grid by means of formulas for passing from one grid to another. In these formulas the Gaussian curvature is involved. The question arises, therefore, whether to substitute the Gaussian curvature of the first spheroid or that of the second spheroid. If we substitute the Gaussian curvature of the second spheroid, then this implies that we regard the grid coordinates of the first projection as being on the second spheroid as well as the first; hence the transformation from spheroid to spheroid takes place with the characteristics of the first projection. Conversely, if the Gaussian curvature of the first spheroid is used in the grid-to-grid transformation, then the second grid is assumed to be on both spheroids, and hence the spheroid-to-spheroid transformation takes place with the characteristics of the second projection.

It is possible, by the use of (20), to make a rapid numerical estimate of the length distortions introduced by mapping from one ellipsoid to another. We need only apply (32) of Chovitz's paper, calculating the a_{ij} by means of Chovitz's table, but replacing K by $K' - K$.

Let us now consider the Helmert technique of mapping from one ellipsoid to another. It has been pointed out by Bodemüller (1944) that this projection resembles the Hatt projection, often called the azimuthal equidistant projection of the ellipsoid on the plane. That is to say, by the Helmert technique the polar co-ordinates of a point, that is, its geodetic distance and azimuth from a central point, are unaltered. It follows that the rectangular co-ordinates on the Hatt projection, which amount simply to the resolution of the polar co-ordinates into Cartesian co-ordinates, are likewise unaltered.

We see, then, that the mapping of one ellipsoid upon another, by the Helmert method, bears the same relation to the isoparametric technique as the Hatt projection bears to the general body of useful map projections, at least so far as the deformations in length are concerned.

In the above-mentioned paper Bodemüller (1944) describes four other projections of one ellipsoid upon another. The first of these which he denotes by U_1 is a conformal projection of one ellipsoid upon another, in which all azimuths of infinitesimal lines are preserved. Evidently we shall be able to obtain this property if we map the first ellipsoid on to a plane, by the Mercator projection, in which the position-angle of an infinitesimal line is equal to its azimuth on the earth's surface; and then transfer from the plane to the second ellipsoid by the inverse

formulas for the Mercator projection. Since the Mercator projection is locally Cartesian only near the equator, it is evident that this method will distort areas at high latitudes by an amount considerably greater than necessary, as Bodemüller points out.

The second of Bodemüller's projections, U_M , is conformal and the distortions of length are zero along the central meridian; furthermore, the rate of change of length distortion is zero along the central meridian. It is thus a representation analogous to the transverse Mercator or Gauss projection.

I shall show that U_M must be identical with the mapping produced by the isoparametric method, using the transverse Mercator projection as the intermediary. To show this, let us denote the latitude and longitude on the original spheroid as ϕ, λ . From these, we calculate, by the aid of the usual tables for the transverse Mercator, appropriate to the first spheroid, the plane co-ordinates u^1, u^2 (which are, of course, the ordinary x and y , or N and E). In the same manner, on second spheroid, let us denote the latitudes and longitudes as ϕ, Λ , and let us consider these as formed from ϕ, λ by the transformation U_M . Let us form rectangular co-ordinates v^1, v^2 from ϕ, Λ , as before, by the use of standard tables for the transverse Mercator, appropriate to the second spheroid. Let us further specify that $u^1 = v^1, u^2 = v^2$ for at least one point of the central meridian, as can be done by the addition of a constant to v^2 , if necessary.

Now the mapping of u^1, u^2 on to v^1, v^2 is a conformal mapping, since (a) the mapping of u^1, u^2 on to the first ellipsoid is conformal; (b) the mapping of the first ellipsoid on the second ellipsoid is conformal; and (c) the mapping of the second ellipsoid on to the plane of v_1, v_2 , is conformal. It follows that $v^1 + iv^2 = f(u^1 + iu^2)$ where f is an analytic function. Furthermore, we have that

$$\begin{aligned} u^1 &= v^1 \\ u^2 &= v^2 \end{aligned}$$

not only at a single point of the central meridian, by hypothesis, but at all points of the central meridian, because, (a) the central meridian remains a geodetic line in all of the mapping involved; (b) the central meridian coincides with the axis of the ordinates on both projections by the definition of the transverse Mercator; and (c) the scale is unaltered along the central meridian, by the definition of the transverse Mercator mapping of the ellipsoid on the plane, and the analogous definition of the mapping of one ellipsoid on another by the transverse Mercator. Hence we have

$$u^1 \equiv v^1 \quad \text{and} \quad u^2 \equiv v^2$$

for all points within the area in which the mapping is free of singularities, by a well-known theorem in the theory of the complex variable (Osgood, 1928). It follows that the isoparametric method of mapping by way of the transverse Mercator projection is identical with Bodemüller's U_M .

This may also be established by inspection of Bodemüller's (101'), if we note that the bracket in Bodemüller's formula is approximately the logarithmic differential of the Gaussian curvature, that is

$$\frac{\delta K}{K} = \left[\frac{\delta a}{a} - \cos^2 \phi (1 - t_0^2) \delta a \right] \quad (21)$$

where, following Bodemüller's notation, a is the earth's semi-major axis, α the flattening, t_0 the latitude at the origin of the projection. The equivalence is somewhat approximate, since it requires setting

$$(u^2)^2 = \frac{\cos^2 \alpha \Delta \lambda^2}{K^2} \quad (22)$$

that is, neglecting terms of the order of the square of the eccentricity or the fourth power in $\Delta\lambda$.

In the same way, the identity of Bodemüller's (105') and (107') with the results of the isoparametric technique on the Lambert and the stereographic projection respectively may be established.

It is evident that the deformations produced by the isoparametric method are of the same order as those produced by other methods; and that the method gives an insight into the deformations which may be useful to the planner

as well as to the computer. It is hoped that the method may be of service to others.

REFERENCES

- Blaschke, Wilhelm, *Vorlesungen über Differentialgeometrie* (Dover Publications, New York, 1945), page 152
- Bodemüller, H., "Ellipsoidische Abbildungen von Rotationsellipsoiden mit Hilfe von Differentialformel", *Mitteilungen des Chefs des Kriegs-karten-und Vermessungswesens*, v. 3 (OKH, Berlin, 1944), page 295.
- Chovitz, Bernard, "The classification of map projections in terms of the metric tensor to the second order", *Bolletino di Geodesia*, v. 11, 1952, page 379.
- Gauss, C. F., "Disquisitiones generales circa superficies curvas", *Werke*, v. 4, 1827, pages 217 to 300.
- Levi-Civita, Tullio, *The Absolute Differential Calculus*, translated by Miss M. Long (Blackie and Son, London, 1926).
- Osgood, W. F., *Lehrbuch der Funktionen theorie*, v. 1 (B. G. Teubner, Leipzig, 1928), page 353.

APPLICATION OF SMALL ELECTRONIC COMPUTERS TO GEODETIC SURVEY COMPUTATION¹

By William C. Aumen, Sales Engineer, The Bendix Corporation

INTRODUCTION

This paper is limited to a discussion of the application of small, general-purpose, electronic digital computers to geodetic survey computations. Computers are considered small if the basic computer costs less than \$100,000, has operating speeds of about 2,000 additions per second, will store internally from 1,000 to 5,000 words of information, and is approximately the size of an office desk. These criteria cannot be adhered to rigidly, but they will serve as reference points.

Some specifications on small computers can be found in a paper presented to the American Congress on Surveying and Mapping in March 1957. Copies of a revised edition of this paper can be obtained from the American Congress on Survey and Mapping or from the Bendix Computer Division, The Bendix Corporation, 1000 Connecticut Avenue, N.W., Washington 6, D.C.

Geodetic survey problems in triangulation, traverse, co-ordinate conversions and astronomy are being solved successfully on electronic computers.

The author has drawn the examples and conclusions expressed herein from two years' experience as a geodesist managing, programming and performing geodetic surveying computations on a Bendix G-15D, and from one year in his present position as sales engineer with the Bendix Computer Division, The Bendix Corporation.

ORGANIZATION OF AN ELECTRONIC COMPUTER UNIT

Of primary importance in the organization of a computer unit of any size is the definite assignment of responsibility for the operation of the unit to a single individual. This individual can then organize the work schedule, order necessary expendable items, channel and document programming efforts and generally keep track of the status of the computer operation. A minimum staff for operat-

ing a small electronic computer would probably consist of a supervisor, a programmer and a computer operator. Since the small computer is best used as an integral part of a computing section, the members of the computer staff should be available for other assignments; however, the main responsibility of the computer staff should remain the operation of the computer itself.

A problem which usually arises in any computer installation is concerned with the "closed-shop" versus "open-shop" mode of operations. "Closed-shop" means that only personnel assigned to the computer are allowed to operate the computer on production runs or to prepare new problems. "Open-shop" means that anyone with a problem to solve may operate or programme the computer. The closed-shop is by far the most common mode of operation for large computers, but the open-shop is much more satisfying to the engineering personnel and the small computer is especially suitable for this type of operation; therefore, almost all small computer installations operate on a more or less open-shop basis.

Electronic computer programming is the most difficult aspect of any computer operation to explain to the uninitiated because of the erroneous publicity that electronic computers *think*. At present, electronic computers *cannot* think; therefore, every step in the solution of a problem must be specified in detail, utilizing a series of commands or codes that the computer is capable of recognizing. To do this detailing job efficiently, the full time of a trained programmer is required. Especially in the early stages of installation and operation, the quality of the programming staff can spell success or failure, but once a library of programmes has been established, it is possible to relax the quality and quantity of programmers somewhat, provided the type of problems to be solved is essentially static. An installation which is continually confronted with new and complex problems should endeavour to retain the best possible programming staff.

The advent of new programming systems, known as compilers, which translate algebraic-type statements into machine-oriented language strengthens the open-shop use

¹ The original text of this paper and that of the following paper were submitted by the United States of America and appeared together as document E/CONF 36/L.36.

of a small computer since specific computer coding is not necessary.

An excellent method of lessening the confusion which usually follows immediately after installation of a computer is to have two or three completed programmes ready for operation *before* the computer is installed. This can be accomplished by training a programming staff several months before installation is planned, or by purchasing completed programmes, or by borrowing programmes from a users exchange group. No matter how it is accomplished, productive operation immediately after installation is completed makes everybody happy—especially management personnel.

If a large amount of repetitive computation is scheduled for the computer, some type of off-line data preparation device improves the utilization of the computer considerably at comparatively little cost.

SPECIFIC GEODETIC PROBLEMS SOLVED

In the field of triangulation are many complex problems, the solutions to which are very laborious and time-consuming. Typical, perhaps, is the solution of the geographic positions of the new stations in a triangulation network after solution of the triangles. By desk calculator or logarithms the direct position computation requires thirty minutes to an hour. By electronic computer the time is reduced to thirty to sixty seconds and the inverse problem of finding azimuth and distance from known geographic co-ordinates is reduced to less than a minute. As an added feature, very precise formulas are as readily solved by the electronic computer as the approximate formulas ordinarily used for hand computing. The Bendix G-15D, formerly managed by the writer, is solving direct position computations by the use of Helmert's formulas which are precise for world-encircling distances. Perhaps it should be pointed out at this time that the size of the computer has no bearing on the precision of computation. Small electronic computers are quite capable of equalling or exceeding the precision available from the largest computer built. Least squares adjustments become routine when the normal equations are solved in a matter of minutes or hours by electronic computer instead of the days or weeks by desk calculator.

Much of the labour of traverse computation is involved in the determination of the latitudes and departures of the courses from the bearings and distances. This problem is elementary for an electronic computer which can make the solutions at the rate of two or three seconds per course. With the advent of the tellurometer and geodimeter, traversing is assuming more importance as a method of establishing precise control; however, computing can become more laborious for these traverses because of the lengths of the courses which rapidly approach or exceed the limits of plane surveying. Again the small electronic computer comes to the rescue by providing a very rapid means of computing these long courses as geodetic lines, eliminating the problems of scale factor and convergence which are associated with grid projections.

In connexion with grid projections, the electronic computer can make the conversion from geographic to grid co-ordinates or reverse in fifteen or twenty seconds very easily. When a fairly large number of conversions is required, the time saving is considerable, at the same time the conversion of only two or three co-ordinates is also quite feasible on a small computer.

Many portions of the computations connected with astronomic latitude, longitude and azimuth determinations lend themselves quite readily to computation by electronic computer. Some of the computations being done on a Bendix G-15D, for instance, are the reduction of zenith distance observations to the meridian for latitude determination, the chronometer correction in longitude observations, mean to apparent declination for latitudes, and portions of the computation of azimuth. There is still a considerable amount of hand computing involved in astronomic computing which could conceivably be done by electronic computer if the right programming effort were applied.

Miscellaneous surveying problems, such as production of special tables, slope, sea level and chord-arc, reduction of field measurements, trigonometric levelling, triangle solution, etc., can all be successfully solved on a small electronic computer.

APPLICATION OF COMPUTERS TO MAPPING

One of the many uses of control surveying is as control for photogrammetric mapping and one of the problems of photogrammetric mapping is the adjustment of instrument readings (as from a stereoplanigraph) to ground control when bridging photo models. At present these adjustments are made for strips of models only, although considerable progress has been towards simultaneous solution of several strips. Various methods of effecting this adjustment have been employed ranging from graphical and semi-graphical to purely mathematical. One of the mathematical solutions entails the least square curve fit of a second degree equation. This method has been programmed for the Bendix G-15D. This programme is capable of solving the adjustment for a strip containing as many as thirty-nine control points. After the solution, co-ordinates for any number of passpoints can be obtained from the conversion equations. The time for the adjustment, exclusive of input and output, is on the order of two minutes. Deletion of specific control points to vary the solution in case of poorly photo-identified stations can be manipulated during the solution.

Another problem encountered in mapping is the computation of the values for plotting grid lines on a map sheet and determination of the sheet size. The mathematics involved in this problem are relatively simple; however, when a multiplicity of scales, grids and units are encountered there is liable to be confusion and error. Only one programme on the Bendix G-15D is necessary to solve all the variations, requiring only the grid interval, scale, unit conversion factor and the grid co-ordinates of the four corners of the sheet to produce the plotting distances from the sheet corners to the nearest full grid lines and the lengths of the neat lines. Computation time exclusive of input is approximately thirty seconds.

Even such routine jobs as finding logarithms, sines, cosines, etc., can be done faster by an electronic computer than by hand as the computer can actually compute the values faster than they can be interpolated from a table.

SUMMARY OF TWO YEARS OF OPERATION OF A BENDIX G-15D

A few figures on a specific computer operation are included for those interested. During two years of one-shift operation at one particular installation, the time of

a Bendix G-15D was apportioned as follows (in percentage):

Production	45.0
Programming	35.1
Out of operation due to failure	4.5
Scheduled preventive maintenance	5.5
Miscellaneous (idle, demonstration, testing)	9.9

Production involved approximately forty different programmes. Even without any effort towards large-scale production, the computer completed a sizable amount of work, for example 10,000 conversions from geographic to Universal Transverse Mercator (UTM) co-ordinates, 4,000 conversions from UTM to geographic co-ordinates, 12,000 direct geographic position computations, 4,000 inverse geographic position computations, 100 least squares solutions, 4,000 grid traverse courses, 80 photogrammetric bridging adjustments and 1,500 triangle solutions. These problems used only eight of the forty-odd programmes available, so it is evident that electronic computers, even small-scale ones, are capable of producing a tremendous number of solutions to a variety of problems.

CONCLUSIONS

Obviously, anyone connected with a successful computer installation will conclude that computers are practically a necessity of life. Conversely, someone observing a poorly run or trouble-ridden installation is likely to decide that electronic computers are more trouble than they are worth. It has been proved that the installation of a small electronic computer can be highly successful and can provide the missing link between desk calculators and the large-scale electronic computer.

The small electronic computer has proved very efficient for computing small-quantity, immediate-result types of problems. The ease of operation allows the geodetic engineer to use the computer himself and thereby obtain with a minimum of delay the intermediate results required for a long-range project. Since the geodetic engineer is relieved of the time-consuming chore of computing, he is able to use more of his time in productive thinking.

Once very precise formulas are programmed for a problem one element of doubt is removed from the results since the precision of the results will be governed only by the precision of the input data. This can be an especially important item when working with very long geodesics.

ELECTRONIC COMPUTATION IN SURVEYING AND MAPPING

By Charles A. Whitten, Chief, Triangulation Branch, Division of Geodesy, United States Coast and Geodetic Survey

Federal agencies engaged in surveying and mapping are making excellent use of the rapid development in the field of electronic computers. The development in the computer industry has been so rapid that it has been difficult to select a type of computer best suited for this particular type of work. "Obsolescence" is a common term when discussing this electronic equipment and we have learned to be somewhat philosophical about the matter. We can be thankful that the same term does not find common usage as applied to our own human endeavour in the field of surveying and mapping.

It was almost twenty years ago that the Coast and

The question "How much money will we save?" is usually raised when an electronic computer installation is suggested. This is a very debatable question since the answer could very well be "None!" However, if there is no real monetary savings it will be because production or speed of production has increased tremendously or because an electronic computer was not warranted in the first place.

Although a small electronic computer will ordinarily produce results at a rate of at least 20:1 over a desk calculator, this should not lead to the conclusion that a computer will replace twenty people. This apparent enigma is readily explained by the voracious appetite a computer has for work. Someone has to prepare and select the input data for the computer and if the computer is to be kept in production constantly it is possible that more data-preparation personnel may be required. The end result, of course, is increased production. Fortunately, the overhead costs of operating a small computer are low enough to permit considerable idle time and still have an efficient and economical installation.

The topic of speed always arises in any discussion of electronic computers and it probably should, since this is one of the strong points of computers. However, there are several aspects of this speed story that should be studied very carefully before the "speed" of a computer is accepted. First, the producing speed of any computer is directly controlled by the speed with which data can be entered and with which results can be obtained in legible form; secondly, accessibility to the computer can become buried under a maze of protocol and management so that the speed inherent in the computer is blocked by an excessive number of human beings handling the input data and the results; third, the computer can be located so remotely from the origin of the work as to preclude the economical processing of small quantities of work. Most of these problems are encountered when small, immediate-result types of jobs are attempted through a large-scale computer installation. It was these same problems that aided the development and growth and have proved the value of the small-size electronic computer. The recent trend is to use small computers as satellites to a large computer to handle small jobs and to reduce basic input data to a more condensed form for entry to the large computer.

Small electronic computers are certainly worthy of consideration as a means of increasing production of geodetic surveying computations.

Geodetic Survey made its first studies in the application of punch card equipment to geodetic computing. However, it was not until after the end of the Second World War that machines of this type were acquired and techniques developed for making geodetic calculations on them. As experience was gained in the use of this type of calculator it was learned that many additional phases of the work in a surveying and mapping organization could be applied to them. The result was the acquisition of a larger and more advanced type of computer. At the present time we are using an IBM 650 magnetic drum calculator. I wish to take this opportunity to describe to you in con-

siderable detail the types of problems that are being processed with this equipment and mention some of the techniques used in the solution of these problems.

The major portion of the work relates to the adjustment of triangulation. I do not need to tell you of the tedious and voluminous computations required when large networks of triangulation are adjusted, but you will be interested to know that practically all of these computations are now being made on this medium-sized electronic calculator.

The classical method of adjustment by variation of co-ordinates on the ellipsoid has been adopted as the basis for most of the work. The only information needed as "input" is the geographic positions of the fixed or previously adjusted control points, lists of observed directions and approximate geographic positions of the new points which are to be adjusted. Values determined from field computations are generally adequate for use as these approximate positions.

The 650 calculator is not large enough to accept these input data and then furnish "output" of adjusted positions, lengths and azimuths in a single operation. It is necessary to use a series of programmes to determine the final values. Some of the individual steps take only a few minutes of time while one or two of the major steps may require hours or even days for a very large adjustment.

The most time-consuming part of any adjustment is the solution of the network of normal equations. The mathematician in charge of the project endeavours to plan the work in such a way that the number of multiplications or steps required in the solution of the normal equations will be a minimum. Because a computer follows instructions in numerical sequence, the mathematician must select and pre-determine the order in which equations are to be solved. A number code is used for the unknowns. The digit 2 in the units position represents the "z" or rotation unknown, the digit 3 represents the latitude unknown and the digit 4 the longitude unknown. Other digits can be used for special purposes and with certain significance, as I will explain later.

The 10, 100 and 1,000 place digits are available for station numbers. For example, the three unknowns for the first point will be 12, 13 and 14, the three unknowns for the second point will be 22, 23 and 24, etc. Thus, by the assignment of numbers to individual points the mathematician establishes the order in which the unknowns will be eliminated in the solution of the networks of equations. These same numbers for station identification will be used in all later steps, whether referring to positions, directions, lengths or azimuths or corrections to any of these quantities.

These numbers must be assigned to these individual points by carefully inspecting a sketch of the survey and considering the interrelationship of points. Equations will contain coefficients of unknowns of points that "see each other". Judgement and experience are required in this step and as yet we have not attempted to programme this operation for an automatic computer.

After the station numbers have been assigned, these numbers are placed in the lists of observed directions adjacent to the conventional station name. Now the data may be key punched, with each observation being punched in an individual card with a "from" and "to" station number identification. These cards will serve to activate other programmes.

In the adjustment by variation of co-ordinates it is necessary to have a computed network of azimuths that is mathematically consistent within itself with a computed azimuth for each observed direction. This mathematically consistent network may be formed by making indirect or inverse computations between preliminary assumed geographic positions and whatever previously adjusted points are to be held in the computations.

These cards which were prepared from the lists of directions automatically indicate the lines for which inverse azimuths are needed. The "from" and "to" station designations indicate the geographic positions which must be paired for computing inverse azimuths, lengths, etc.

After studying several different types of inverse computation the Gauss mid-latitude method as modified by Rainsford of the British Overseas Survey and Meade of the Coast and Geodetic Survey was applied to the computer. This method is accurate for lengths ranging from a few metres to 600 miles. Briefly, it is an application of series expansion with latitude, and the differences of latitude and longitude as input. It is relatively simple to change the programme for computing on different ellipsoids.

The next programme in the general series computes the absolute term of each observation equation by comparing the computed azimuth of the lines with the observed direction of the line. Another small programme selects the proper absolute terms needed to compute triangle closures. A tabulation of these triangle closures enables the person in charge of the adjustment to determine the over-all accuracy of the field work and to stop any blunders which might have developed in the handling of input material. When the preliminary inverse computations have been made, the "output" includes the functions which can be used in the computation of the coefficients in the observation equations. The next programme in the series takes care of this step. This same programme performs all of the cross multiplications which are needed when observation equations are normalized.

After the cross multiplications have been made within the observation equations, a programme designed to select, sort and add these products together will produce the normal equations.

The matrix arrangement of the drum in the calculator is particularly well adapted for the storage of normal equations. The drum has an arrangement that can be described as 100 columns and twenty rows. We cannot use the entire drum for storing the matrix because the instructions for solving the equations require a considerable portion of the drum. However, we can load a matrix which has forty-eight columns and sixteen rows. If a matrix is wider than forty-eight columns the programme may be modified to load a matrix ninety-six columns in width but the number of rows is reduced to eight. This same process could be used to take care of even larger matrices.

The Gaussian elimination method is used with the modification proposed by Cholesky, who was an officer in the French Army in the First World War. This Cholesky modification is particularly suitable for electronic calculators because each term in the reduced normal equation is the geometric mean of the two terms with which you are familiar in the standard Gauss-Dolittle technique. The use of the Cholesky method cuts in half the number of

figures which must be stored within the computer or, in other words, twice as many equations can be loaded at one time.

The use of this modification did present an interesting problem to our programmers. In the Cholesky method, the square root of the leading or diagonal term in the normals must be calculated. When we insert condition equations for length, azimuth or position into a set of normals, the leading term, when reduced by the effect of preceding equations, will become negative. The square root of this quantity is imaginary. By using a coded number, 5, 6 or 7, in the units position for these condition equations the calculator can detect the imaginary number and go into a sub-routine for the proper calculation.

With a large network of equations, it is necessary to subdivide into small blocks or partitions. Each block is solved as a unit but while the numbers are in the computer all sums of cross multiplications needed in the reduction of the following blocks are punched on cards as output. Later, these quantities become input with the proper block. The operator must exercise some care to see that the blocks are arranged properly but the programme includes a technique for checking mis-handling by the operator.

The back solution or substitution technique is carried out on another programme in much the same manner as the previously described forward solution.

After the unknowns of the adjustment have been computed, they are substituted in observations equations for the computation of the residuals. These same unknowns are also used to correct the preliminary geographic positions and then final inverse computations are made for all the lines of the network.

An additional programme selects the residuals that are needed to compute corrections to angles in each triangle as well as the triangle closure. A tabulation of these quantities will show any place in the network where the observations might have been distorted in the process of the adjustment. This problem of distortion is very important in a network such as we have in the United States. In a structural sense, the area networks are stronger than the arcs which surround them, yet the arcs were adjusted first. Now we are endeavouring to fit the nets to them. Experience has shown that unless we have accuracies approaching 1:100,000 for the arcs, we will find rather severe distortion problems in the nets. I point out this problem to you merely to emphasize the purpose we had in making the recent revision in our basic specifications in which the fundamental minimum accuracy requirement for first-order triangulation was increased from 1:25,000 to 1:50,000.

These same techniques which I have described for adjusting triangulation have been modified to include observation equations for length so that combined networks of triangulation, trilateration and traverse may be adjusted simultaneously.

The Coast and Geodetic Survey co-operated with the Government of Ethiopia in establishing fundamental horizontal and vertical control in the Blue Nile region. The network of triangulation consisted of 252 primary points, 118 supplemental points, nine invar base lines, seven tellurometer base nets and eleven Laplace azimuths. The adjustment of this large net was completed using the computer programmes just described.

The programmes that I have described thus far do not make use of any direct method for the computation of geographic positions. However, there are programmes for several different types of geodetic and cartographic work which require the use of the direct method. The basic programme for this calculation is a modification of the method developed by Simmons of the Coast and Geodetic Survey some twenty years ago. His method makes use of a pre-computed meridian arc. On the electronic calculator, the values for the meridian arc are computed as needed by a series expansion. There is a free interchange between latitude expressed in radian measure and meridian arc expressed in metres. We have not made any effort to compute a maximum length of line by this method but rather we use an iterative technique of extending lines in units of 100 kilometres or less. I might mention that for all types of geographic position computation, direct or indirect, we use a standard practice of working to the fifth decimal place of seconds of position, third decimal place of azimuth, and millimetres in length.

Each of the fifty states of the United States has an individual co-ordinate system. For the larger states several zones may be required. Three different types of projections are used: Lambert, Transverse Mercator and Oblique Mercator. Programmes have been developed for the transformation of geographic positions to any of these co-ordinate systems or vice versa, i.e., transformation of plane co-ordinates to geographic positions. These programmes are series expansions with only six or eight constants for an individual zone. A similar programme computes UTM co-ordinates. In connexion with our co-operative survey programme in Ethiopia we found it necessary to compute tables for the computation of geographic positions when using desk calculators. Tables for both natural and logarithmic functions were computed on the calculator and the tables printed by photolithography from tabulations from punched cards. This programme is one that will not be used very often but it will be retained so that if any agency wishes tables of this type on any previously accepted ellipsoid or any new ellipsoid, the tables can be readily computed and published.

The routines that were developed for the state plane co-ordinates, UTM, latitude functions, etc., were drawn upon to develop a programme for computing the micrometer settings for the ruling machine used in drawing meridians, parallels and grid lines on base mapping sheets at any given scale. While this problem may not seem difficult to a cartographer it does become rather complex when one must consider the mathematical interrelationship of the grid of the ruling machine, the rectangular grid of the ground, the framework of meridians and the parallels and the scale of the map sheet so that all drafting may be done without removing or shifting the base sheet during the operations of drafting.

A few years ago Brigadier Martin Hotine, Director of the British Overseas Surveys, proposed the use of three-dimensional techniques in adjusting triangulation. Considerable research and some actual adjustments have been made using this technique. We are not using the procedure on routine work but we are continuing our studies in its general application.

It is interesting that the programmes we have developed and are working on at the present time for the adjustment of aerotriangulation make use of the mathematical techniques required in the three-dimensional adjustment proposed by Brigadier Hotine. Our first approach in the

photogrammetric technique was to adjust a strip of photos by a cantilever method. Third degree equations were used along the axis of flight with second degree equations transverse to the axis of flight. The same basic programme can be used for either horizontal or vertical adjustment. No attempt has been made as yet to combine and make a simultaneous horizontal and vertical adjustment by this cantilever method.

Within the past year techniques have been perfected for the analytical adjustment of aerotriangulation. Other reports presented at this meeting will contain descriptions of the instruments being used to develop the digital information required for this analytical treatment. The final phase of this work which will include a grand adjustment of adjacent strips, referred to as "block adjustment", will be completed in the near future.

Data processing techniques have been applied to the reduction of geomagnetic observatory records. The Coast and Geodetic Survey maintains seven permanent magnetic observatories. The observations which are recorded hourly are processed and prepared for publication. An automatic magnetometer has been designed for installation at an observatory and will produce continuous records of the variation in the earth's magnetic field. A computer programme is being developed which will process this material. The volume of computing and data processing will be extremely large but the final data will show a great deal more detail than has been available in past years, when only hourly values were recorded.

The Coast and Geodetic Survey has been processing the geomagnetic data used in the construction of world isogonic charts. The next series to be published will be on an epoch of 1965. Some of the preliminary work involving these calculations is under way.

Another unique application in the field of geophysics is the computation of epicentres of earthquakes from arrival time data submitted by seismological stations from all over the world. Several hundred epicentres are calculated each month and the results published for distribution to seismologists throughout the world.

Every federal organization has responsibilities in the fiscal and budget area of administration; this has been rather facetiously described as a housekeeping operation. I do not want to predict or forecast that every home will require an electronic calculator for balancing personal budgets, but in an agency where several different types of employee classifications exist, making necessary federal tax deductions and even state tax deductions along with insurance, bond, allotment and many other payroll deductions, and where cost records for projects and functions must also be maintained, you can readily appreciate that data processing on electronic equipment becomes an efficient method of keeping records both as regards accuracy and timeliness of reporting.

At various times we have received requests for copies of these programmes. Perhaps some of you in this group have sought this type of information. Our general policy has been to assist federal agencies of other countries or of our own United States or state and municipal agencies engaged in this type of work in every way we can. We do not have the resources to prepare complete brochures on each of the programmes with full instructions so that the uninitiated might be able to perform some type of computing in a robot manner. Our basic philosophy is that the computer is merely a tool used by experienced technicians and that an agency should not try to use a tool of this type if it does not have experienced personnel. We welcome visitors and are always glad to demonstrate the methods we are using. We have found that when experienced people have visited our shop they do not find it necessary to ask for a "canned" programme. They would rather develop their own programmes using routines and techniques familiar to their own group.

This entire field of computer development and computer application is changing constantly but that fact should not dissuade any group from becoming interested and actually using this new tool. It is quite essential that those of us who are in surveying and mapping activities make the best possible use of these new techniques in computing and be alert to the broader applications which we are confident can be made in the future.

IS THE SEA LEVEL FALLING OR THE LAND RISING IN SOUTH-EAST ALASKA?¹

Background paper by William Shofnos, Assistant Chief, Marine Data Division, Office of Oceanography, United States Coast and Geodetic Survey²

South-east Alaska consists of a relatively narrow strip of mainland together with a vast chain of adjacent islands, known as the Alexander Archipelago, which extends in a general north-west and south-east direction between latitudes 55° N and 60° N. The topography is strikingly picturesque with deep and narrow gorges, precipitous cliffs, steep mountains rising directly from the sea and shores interspersed by numerous waterways and fiords. Through these inner channels runs the "Inside Passage", the sheltered route which extends from Puget Sound to

Skagway. In the northern part of the region there are glaciers which are notable for their number and size.

For some years we have recognized that physiographic changes have been taking place in this picturesque area. Evidence from observations at our tide stations maintained at Skagway and Juneau together with reports of marked changes in the elevations of tidal bench-marks in other parts of the area led to a decision by the Coast and Geodetic Survey to initiate a special tidal survey in 1959 to provide present-day values of tidal datum planes. Because of the extensive area involved, the project was divided into two parts. Approximately half of the survey covering the general vicinity of Icy Strait-Lynn Canal, was completed in 1959. The remaining half, extending southward to the Frederick Sound area, was completed during the 1960 season.

¹ The original text of this paper and that of the following paper were submitted by the United States of America and appeared together as document E/CONF 36/L 37.

² Most of this paper is the same as the one presented by Admiral Pierce at the 20th Annual Meeting of the American Congress of Surveying and Mapping. New data have been added by Mr. Shofnos.

PLACE NAMES

Perhaps we might digress a little at this point to refresh our memories on the history of some of the place names in the area.

Juneau. Two early prospectors named Juneau and Harris discovered gold in the vicinity in 1880, leading to the first Alaska gold rush. There was early rivalry between the names Juneau and Harrisburg for the name of the camp, and United States naval officers also called it Camp Rockwell in 1880 for Commander Charles H. Rockwell. A local election resulted in the choice of Juneau and a post office of that name was established in April 1881. Juneau was officially made the capital in 1900, but the territorial executive offices did not move there from Sitka until 1906.

Taku Inlet

Taku Glacier. The native name for the glacier prevailed after it had been named Schulze Glacier in 1883, for Paul Schulze, president of Northwest Trading Company, and Foster Glacier in 1890 for Charles Foster, then Secretary of the Treasury. There are several other geographic features bearing the name Taku.

Lynn Canal. Lynn Canal extends from the junction of Chatham Strait and Icy Strait for some eighty miles north to its head at Skagway, a deep narrow fiord. It was explored by Vancouver in 1794 and named for the place of his birth in England.

Skagway. While still important as the terminus of the White Pass and Yukon Railway, and of a pipeline to Canadian territory, Skagway enjoyed its greatest importance at the time of the Klondike gold rush. At its height the population of Skagway and nearby Dyea was from 10,000 to 20,000. Prior to the completion of the railway in July 1900, extreme hardships were encountered and had to be overcome by all bound for the Klondike and Yukon gold fields. In 1898 alone 25,000 persons are said to have crossed White Pass (2,890 feet) and Chilkoot Pass (3,500 feet).

Skagway was variously spelled before the present form of the name became well established. The native word from which it was derived is said to mean "home of the north wind".

Haines. This has always been the second important settlement on Lynn Canal. It was the site of an early Indian village, at which a trading post and Presbyterian mission had been established by 1881. A post office was opened in 1884. It is connected by highway with the Alaska Highway at Haines Junction in Yukon Territory, Canada.

Davidson Glacier. Located on the west shore of Lynn Canal opposite Seduction Point this glacier was named in the late 1860's for George Davidson who for more than forty years was with the Coast and Geodetic Survey, and subsequently was prominent in scientific circles in California until his death in 1910. The highest elevation in the city of San Francisco is named Mt. Davidson in his honour.

Cross Sound. Named by Sir Francis Drake on 3 May 1778, a day designated on his calendar as Holy Cross Day. In earlier years it was confused with Icy Strait, a name of Russian origin. Present usage is to apply Icy Strait to the eastward and Cross Sound to the westward.

Glacier Bay. General areas explored by Vancouver in 1794 and also by early Russians. Named Glacier Bay

in 1880 by Commander (later Rear Admiral) L. A. Beardsley, USN. John Muir was there in 1879 and 1880. Professor Harry Fielding Reid of Johns Hopkins made extensive explorations in 1890 and 1892 (his report published in volume IV of the *National Geographic Magazine*, 1892, pages 19-84). The Geological Survey 16th Annual Report for 1996, part I, pages 415-461, also provides much information about the glaciers in the bay as they existed up to a very severe earthquake in the adjacent Yakutat Bay area in 1899. Prior to that date the bay was frequently visited by excursion vessels but following the earthquake the bay was clogged by ice for many years. Glacier Bay National Monument, now containing almost 3,600 square miles, was first established in 1925. The Monument contains over twenty tremendous glaciers and many others almost equally impressive. They illustrate all stages from actively moving ice masses to those that are nearly stagnant and slowly dying.

Muir Inlet

Muir Glacier. Named for John Muir about 1880. The remarkable recession of Muir Glacier and the consequent lengthening of Muir Inlet is noteworthy. Between Muir's first visit in 1879 and Reid's first visit in 1890 the glacier had receded more than two miles. Due to normal recession and the effects of the 1899 earthquake, on the 1952 revision of nautical chart 8306 the north end of the inlet is now some fifteen miles north of the southern end of the glacier as reported by Muir in 1879. The other major glaciers in the bay have all had some recession, and many of the smaller ones have disappeared. It is now possible to reach Grand Pacific Glacier through Tarr Inlet, a short distance inside of Canada.

It is interesting to note how the names of the geographic features in this extensive waterway of south-east Alaska reflect the early explorations of many nations, for example, Port Alexander, Baranof Island, Cape Chivikof, Arguello Island, Boca de Quadra, Delgada Point, Beauchamp Island, Gastineau Channel, La Perouse Glacier, Monte Carlo Island, Byron Bay, Dickens Point, Pitt Island, Napier Point, and of course the Indian names, such as Chilkat Inlet, Hoonah, Metlakatla and Skookum Chuck.

TIDAL SURVEY

A total of thirty-nine stations were established in connexion with this project during the period 1959-1960. During the 1959 operations twenty portable tide gauge stations were established. With one exception, stations were selected at places where tidal bench-marks had been previously established so that relative changes in elevation could be determined. One new site for tide observations was selected on Composite Island in the north-west arm of Glacier Bay to provide additional information for this active area in future years. The tide gauge structures varied considerably from place to place, being built to meet the conditions encountered. The first ten gauges were installed as rapidly as possible. Additional structures in the second set of ten were erected and levels run between bench-marks as time from tending the initial ten gauges permitted. As soon as a sixty-day series was completed, the gauge was shifted to a new tide well. Observations commenced as soon as the tide staff was levelled to the marks. The tide gauges were serviced by both air and water transportation, air travel being used as an expedient only when weather conditions were favourable.

During the 1960 operations nineteen portable tide gauge stations were established. With two exceptions, stations were selected at places where tidal bench-marks had been previously established so that relative changes in elevation could be determined. One new site for tide observations was selected at Mole Harbor, Seymour Canal, and one at Tenakee Springs, Tenakee Inlet, in order to provide additional information for this area in future years.

Records from the stations were analysed to determine the various tidal characteristics, mean values being obtained through simultaneous comparisons with results for the control tide station at Ketchikan. The primary objective, however, was the derivation of data for use in computing changes in elevations. The datum derived for this purpose was half-tide level as the old elevations were referred to that datum. Half-tide level, also called mean tide level, is a plane midway between mean high water and mean low water. Normally, mean sea level datum is used but equally satisfactory results may be obtained through comparisons of half-tide levels. Based on data from our tide stations at Skagway and Juneau, which have been in operation for a period of from fifteen to twenty years, mean sea level is one-tenth of a foot above half-tide level and the two datums are subject to the same variations. A change in elevation between half-tide level of different tidal series in this area consequently is a measure of change in sea level.

RELATIVE CHANGES IN ELEVATION

The changes in elevation that have taken place at the various stations are shown in table 1. The figures in the column under Period show the respective years at each station during which determinations of half-tide level were obtained. There are instances where more striking changes would be indicated if results from earlier series were used. Due to the very short period of these earlier tide observations, however, the derivation of the datum plane was not considered satisfactory.

Selecting places where the period between the determination of half-tide level approximates half a century, we obtain the following results:

- Skagway* at head of Lynn Canal—change of 3 feet in 50 years;
- Juneau*, Gastineau Channel—change of 2 feet in 48 years;
- Swanson Harbor*, Icy Strait—change of 3 feet in 58 years;
- Inian Cove*, North Inian Pass—change of 4½ feet in 57 years;
- Petersburg*, Frederick Sound—change of ½ foot in 50 years;
- Thomas Bay*, Frederick Sound—change of 2 feet in 73 years;
- Killisnoo Harbor*, Chatham Strait—change of 1½ feet in 65 years;
- Haley Anchorage*, Peril Sound—change of 1 foot in 64 years.

To obtain comparable values for the various stations in the project, where the period of years between datum determinations varies considerably, we have computed the rate of change per year for each station. With this we find that fairly consistent rate of change values can be obtained for separate areas. The largest changes based on stations occupied in 1959 have occurred north of Icy Strait. Along the shores of Glacier Bay the tide records indicate an average change of about 0.11 foot per year.

The effect of the large changes in Glacier Bay appears to extend to the Inian Islands where the records show a slightly diminished rate of about 0.08 per year. To the eastward, in Lynn Canal, the change has been at the average of about 0.07 foot per year. For the whole area north of Icy Strait we thus obtain an average change at the rate of 0.09 foot per year. Southward, along the shores of Cross Sound and Icy Strait and the waterways in the general vicinity of Juneau the indicated change is smaller, being of the order of 0.05 foot per year.

The largest changes in the area surveyed in 1960 occurred at the east end of Frederick Sound and east side of Stephens Passage in the amount of about 0.03 foot per year. In the south-west end of Frederick Sound the change was about 0.01 foot per year and to the west in Keku Strait the change was less than 0.01 foot per year. Proceeding westward from Frederick Sound into Chatham Strait, we find the rate of change about 0.02 foot per year. Along the outer coast in the Salisbury Sound-Peril Strait area, observations indicate a change of about 0.01 foot per year.

The stations occupied in 1959 were all north of 58° North latitude and indicated a change in land elevation ranging from 0.05 to 0.11 of a foot, while the stations occupied in 1960 were all south of 58° North latitude and indicated a change in land elevation of zero to 0.03 foot. It would then seem that the area of considerable change in land elevation does not extend much below the 58° North latitude.

As measured by the relation of half-tide level to bench marks, these changes would appear to indicate that sea level has been falling. Such changes, however, are relative because in a particular area a change in elevation as referred to local sea level could represent an actual lowering of the sea or land uplift. Studies of sea level along the coasts of the United States and other countries throughout the world provide evidence of a slow general rise in the level of the oceans during the past fifty years or more. It is our conclusion, therefore, that sea level could not be falling in the limited area under discussion while it is rising in the great oceanic basins. The movement in the Icy Strait-Lynn Canal area of south-east Alaska, consequently, represents land emergence rather than falling sea level. This land uplift is attributed to the release of ice load by the melting of the numerous glaciers in the area. This hypothesis is supported by a report of IGY studies of glacial changes in south-east Alaska in which Goldwait brings out the fact that most of the glaciers have receded markedly for the past century. Also, investigations carried out in the Scandinavian countries have disclosed similar land uplift.

The changes in bench-mark elevations disclosed by the tidal survey are only part of the over-all picture, for hydrography is also affected. Lieutenant-Commander E. W. Richards, who was in charge of the tidal survey, also directed some special hydrographic investigations and reported that many critical depths in the area have shoaled about one-half to one fathom since the original survey. Rocks that were previously charted as covered at all stages of the tide have in recent years been observed by local inhabitants as baring at low water. Such extensive land movement has special significance for in it we see additional problems that must be taken into consideration in adequately surveying and mapping the extensive areas of the new state of Alaska.

Table 1. South-east Alaska: changes in land elevation evidenced by plane of half-tide level

<i>Place</i>	<i>Period</i>	<i>Number of years</i>	<i>Change (feet)</i>	<i>Rate of change (feet per year)</i>
Lynn Canal:				
Skagway	1909-1959	50	2.94	0.06
Haines	1922-1959	37	2.73	0.07
Wm. Henry Bay	1922-1959	37	2.74	0.07
Glacier Bay:				
Muir Inlet	1940-1959	19	2.18	0.11
Willoughby Island	1939-1959	20	1.75	0.09
Bartlett Cove	1938-1959	21	2.73	0.13
North Inian Pass:				
Inian Cove	1902-1959	57	4.33	0.08
Cross Sound-Icy Strait, etc.:				
Lisianski Inlet	1917-1959	42	1.90	0.05
Elfin Cove	1938-1959	21	1.34	0.06
Hoonah	1923-1959	36	1.87	0.05
Swanson Harbor	1901-1959	36	1.87	0.05
Funter Bay	1922-1959	37	1.71	0.05
Auke Bay	1937-1959	22	1.39	0.06
Juneau	1911-1959	48	2.05	0.04
Annex Creek	1937-1959	22	1.02	0.05
Greely Pt.	1937-1959	22	1.01	0.05
Frederick Sound:				
Petersburg	1910-1960	50	0.61	0.01
Thomas Bay	1887-1960	73	1.93	0.03
Cleveland Passage	1920-1960	40	0.92	0.02
Pybus Bay	1925-1960	35	0.59	0.02
Stephens Passage:				
Good Island	1920-1960	40	0.95	0.02
Windham Bay	1920-1960	40	1.11	0.03
Keku Strait:				
Entrance Island	1927-1960	33	0.15	0.00
Chatham Strait:				
Red Bluff Bay	1926-1960	34	0.21	0.01
Killisnoo Harbor	1895-1960	65	1.49	0.02
Olga Strait:				
Olga Point	1929-1960	31	0.42	0.01
Salisbury Sound—Peril Strait:				
Scruggy Point	1928-1960	32	0.28	0.01
Haley Anchorage	1896-1960	64	0.80	0.01

ESTABLISHMENT OF TIDE GAUGES PREPARATORY TO THE DEVELOPMENT OF NATIONAL GEODETIC CONTROL NETWORKS

Background paper by James B. Small, Chief, Levelling Branch, Division of Geodesy, United States Coast and Geodetic Survey

The selection of locations for tide gauges for the control of a level net depends on many factors such as the coast line of the country under consideration, free communication for the tide, sufficient depth of water at all stages of the tide and freedom from runoff effects, access to the interior to establish ties to the control net, etc. What is desired is a location at which zero potential can be determined. This would be the mean level of the ocean unaffected by currents, atmospheric variations, wind, density variations, etc. Mean sea level as determined by averaging the hourly heights of the tide over a long period of time can approximate this zero potential but cannot exactly be equal to it, since it is extremely difficult to remove all of the disturbing elements.

An important consideration is that the sites selected for the location of a primary gauge should represent open coast conditions as far as possible where the mean water level is not affected by runoff that would tend to raise mean values. At the site selected for the gauge a group of at least three (and preferably five) bench-marks should be established as a reference for the gauge. These marks should be installed in bedrock if possible. If rock is not available, they should be established in the most permanent existing structures, or concrete posts should be constructed for the purpose. The marks should be established far enough apart so as not to be subject to movement resulting from the same contributing factor. In other words, two marks should not be installed on the same building but

they should be at least one-quarter of a mile apart if possible. The stability of these bench-marks should be checked by levels at least twice each year.

The density of tide station distribution is one which should not arbitrarily be placed on a distance basis. If along a coast the tidal régime is about the same for a long distance, control tide stations spaced 100 miles apart can be considered as adequate and desirable distribution. However, there are a number of places where the type of tide varies considerably at two localities much less than 100 miles apart. In these cases, a study should be made of the area and a sufficient number of control tide stations established so that all of the various tidal conditions will be adequately covered. Similar considerations must be given to the distribution of secondary stations. In areas where the 100-mile spacing is used for control stations, a fifty-mile spacing can probably be considered as adequate for secondary stations. The observations at primary stations are taken with a standard automatic gauge over a long period of time whereas the observations at secondary stations can be taken with portable gauges usually for periods of less than one year. The observations at the secondary stations can be reduced to mean values by comparison with a suitable primary station for which the equivalent of a nineteen-year series is available.

In using mean sea level as zero in the establishment of a vertical control datum it is important that the observations be simultaneous. Along the coasts of the United States mean sea level is rising in varying amounts up to 0.021 foot per year. Along the Atlantic coast the rate is about 0.011 foot per year, while along the Gulf coast it is about 0.021 foot per year and on the Pacific coast about 0.005 foot per year. In view of the changes in mean sea level, it is readily seen that if data for different epochs were used there would be differing results.

In the establishment of a vertical control datum for the United States a least squares adjustment was made in 1929

of the first-order levelling in the United States and Canada in which mean sea level was held at zero for twenty-six tidal stations along the Atlantic and Pacific Oceans and the Gulf of Mexico. The 100-mile maximum spacing of primary tide stations recommended above is a closer spacing than that available in the United States at the time of the 1929 General Adjustment of the level net.

The tide observations for the control of a first-order level net should be over a period of nineteen years to take into consideration certain cycles of the moon's nodes. When the adjustment of the level net is set up, an additional equation between adjacent tide stations needs to be included in the adjustment to hold these at zero. There might be a need for the selection of certain mean sea level determinations and the rejection of others due to the fact that holding all values might punish the levelling unduly. The rejection of certain stations might be due to any of the following causes: coastal subsidence due to the removal of oil, water or gas; earthquakes; fault lines; certain prevailing currents, etc.

If there are bordering countries with level nets with data based on tidal observations, it would be advisable to have one least squares adjustment of all levelling to bring about consistency and not have two elevations for the same mark at a boundary.

The International Union of Geodesy and Geophysics has recommended that each country consider the computation and publication of geopotential heights for each bench-mark as well as orthometric heights. The geopotential heights would be based on measured values of gravity determined along the route of the levelling. This might make it desirable to use a single zero potential determination as a basis especially if the level net is of high quality. Some countries have used mean sea level as determined at only one location as a basis for their elevations, as in the case of Great Britain.

(c) International connexion of geodetic co-ordinates

PROPOSAL BY AUSTRALIA¹

Geodetic surveys are now continuously available from the European networks to Malaya, and it is known that it is possible to continue such surveys from Malaya, through Indonesia, to the Island of Timor.

Furthermore, it is certain that a Hiran or Aerodist connexion can be made from the Island of Timor to the mainland of Australia.

In view of the increasing efficiency of electronic aids

¹ The original text of this paper appeared as document E/CONF. 36/L.1.

to navigation, it is felt that the need for accurate geodetic connexions between all countries of the world is becoming urgent, and it is therefore suggested that the countries concerned in the above geodetic connexion should take action to complete the necessary surveys.

The proposal is made that an advisory committee be formed, consisting of representatives from each interested country, with a view to examining the problems involved and recommending a practical plan and a time-table for completion of the geodetic connexion between Europe, Asia and Australia.

BACKGROUND PAPER SUBMITTED BY THAILAND¹

At the General Assembly of the International Union of Geodesy and Geophysics held in Stockholm in 1930, a resolution² was passed expressing the wish that Thailand and her neighbouring countries collaborate with each other in effecting the junction of their triangulation systems with the object of continuing, if possible, the chain of triangulation to the Australian continent and the Philip-

pinas. Following this resolution, considerable progress has already been made, but all the required geodetic connexions in the region have not yet been achieved, particularly between the continents and significant islands.

The Eleventh Assembly of the International Association of Geodesy at Toronto formed a Commission to study and undertake the adjustment of the triangulation systems of south Asia. The objective of the adjustment was to provide a unified system of geodetic positions for scientific purposes. The work carried out by the Commission is in

¹ The original text of this paper appeared as document E/CONF. 36/L.3.

² See *Bulletin géodésique*, No. 27, 1930, page 354.

progress, but the adjustment carried out so far covers only limited areas.

Considering the need for international geodetic connexions not only by cartographic agencies in preparing

accurate maps, but also by scientists in studying the figure of the earth, it is necessary that further steps be taken by the countries concerned to accelerate the completion of the project.

(d) Establishment of standard base lines for calibrating radio-electronic or electromagnetic distance measuring instruments

TECHNICAL PAPER SUBMITTED BY JAPAN¹

If the purpose of establishing a standard base line is simply to calibrate the instrumental constants, it may not always be necessary to have a long base; for instance, in the case of the geodimeter, the modulation frequencies can be calibrated by electronic methods. The remaining problem is to determine the locations of zero points from which the measured length starts and at which it ends, or in other words, to determine the zero correction of the measuring system as a set of the geodimeter and the reflex system which will be used in field measurement.

For this kind of calibration, the shorter the length of the base line to be used the better. Since the considerations of atmospheric conditions and modulation frequencies may be easily dealt with, the length may be determined simply for the convenience of taking a measurement.

We have a geodimeter model II and a spherical reflex system in the Geographical Survey Institute of Japan. We found it convenient to take measurements on several hundred metres by this set of instruments. As the standard deviation of a single observation was about 1.5 centimetres for a length of about fifteen kilometres, it was thought desirable to establish the base line by invar wires.

However, if at least two base lines are established, and if we measure three lengths, that is, the two base lines and their total length, by the geodimeter and the spherical reflex system, it is possible to determine the zero correction.

The accuracy is required only for the sake of applying the principle of coincidence to determine the integral number of waves involved in the lengths to be measured. Therefore, it is not always necessary to know in advance the accurate values of the lengths of the base lines. The accuracy of the determination will increase with an increasing number of base lines, because in such a case the results may be adjusted by the method of least squares.

We once established two base lines 300 metres and 350 metres in length by invar wires and measured the lengths of 300 metres, 350 metres and 650 metres. The zero correction obtained by using the values of the lengths determined by taping and that deduced from the analysis of the results for three different lengths—the lengths of the two base lines and the zero correction being regarded as unknowns—were quite consistent with each other within the limits of the observational error.

The problem may be "which method would be more practical to obtain the same or the required accuracy under specified circumstances?"

In the case of the tellurometer the same principle may be applied except for consideration of ground swing. We have not yet sufficient knowledge in Japan of the accuracy of the tellurometer, but from our experiences to date and the information from papers published abroad, it may be assumed that the tellurometer will be from three to ten times less accurate than the geodimeter, estimated

from the standard deviation of a single observation which is the mean value of a set of measurements.

Consequently, the establishment of the base line for determination of the zero correction of the tellurometer will be easier than that for the geodimeter.

If ground swing does not affect the measurement, the base line itself—established by suitable methods—may be applied. The effect may be surveyed by trial measurement. If the influence of ground swing, however, is so large as to affect the optimum accuracy of measurement, or in extreme cases, if the measurement cannot be made, it will be necessary to establish the base line at another site where ground swing would not affect the measurement.

This kind of base line is not usually measured by tape. The method of using three lengths may not always be applicable for the tellurometer. The British Ordnance Survey once reported in one of their published papers the discrepancy between the sum of the results of the measurements of two lengths and the result of the direct measurement of the total length.

If the purpose of the calibration is not confined simply to measuring the instrumental constant, or the zero correction, but is also used to obtain information about ground swing, which is important in evaluating the tellurometer, then, in order to have various lines of sight, including different topographic conditions and lengths, it will be preferable to establish base line nets, as Dr. Gigas has suggested. Long sites may be included in order to obtain data which would throw some light on the effects of atmospheric conditions.

To increase the number of experiences in various topographic and atmospheric conditions, it may also be desirable for the countries interested in these problems to have such base line nets. We should distinguish between the base line in question and the international standard base lines which are now being established in several countries. It may be considered that these base lines are established as a means of checking the consistency of base tapes or the national standard of length of each country.

It is felt that the proposal for the establishment of a long accurate base line put forward at the Tokyo Conference was for the purpose of calibrating or determining the velocity of a light wave and for studying the effect of atmospheric conditions rather than for calibrating instruments on the basis of the results obtained from geodimeter measurements in Japan.

If the purpose of the establishment of a base line is to measure the velocity of a light wave by geodimeter, it will be necessary to establish a precise base line of suitable length, taking into consideration the optimum measurement and the practicability of establishing a site where the atmospheric conditions may be easily evaluated. For the study of atmospheric conditions, other considerations may have to be taken into account.

From this, it can be concluded that base lines must be established with the accuracy, type, length, location, etc., suitable to their purpose.

¹ The original text of this paper appeared as document E/CONF. 36/L. 88.

AGENDA ITEM 11

Magnetic surveys and world magnetic charts

JAPANESE PROGRAMME OF THE WORLD MAGNETIC SURVEY, 1960-1965¹

Paper prepared by the Committee on the World Magnetic Survey, National Committee for Geodesy and Geophysics, Science Council of Japan

In accordance with the recommendations and resolutions adopted at the Moscow meeting of CSAGI, aeromagnetic surveys of Japan have been planned by the National Committee for Geodesy and Geophysics of the Science Council of Japan. The outlines of the programme are as follows:

(a) ORGANIZATIONS PARTICIPATING IN THE SURVEYS

- (1) Geographical Survey Institute: magnetic surveys over land;
- (2) Japanese Hydrographic Office: magnetic surveys over sea;
- (3) Magnetic Observatory, Japan Meteorological Agency: calibration of instruments.

(b) INSTRUMENTS

Two types of air-borne magnetometers, which are now being developed in Japan, will be used.

For land area: proton precession magnetometer for F, accuracy $\pm 5 \gamma$, rotating coil detector for D and I, accuracy $\pm 0.1^\circ$, photographic instruments for positional data, accuracy ± 200 m;

¹ The original text of this paper, submitted by Japan, appeared as document E/CONF 36/L. 11.

For sea area: saturable core inductor for X, Y, Z, accuracy $\pm 50 \gamma$, Loran navigator for positional data, accuracy ± 1 nautical mile.

(c) PERIOD OF THE SURVEY

The period of the Survey will be from 1961 to 1963. Full reduction of data to epoch 1965.0 will be completed by the end of 1964.

(d) AREA TO BE SURVEYED

The Survey routes are illustrated in figure 28; the total area of the Survey will be about 3×10^8 square kilometres.

(e) CHART CONSTRUCTION

Magnetic charts will be compiled on a scale of 1:10,000,000 for the sea area and of 1:2,000,000 for the land area.

The intervals of the isomagnetic lines are 30' for D and I and 200 γ for intensities over the land, and 30' for D and 500 γ for intensities over the sea.

GEOMAGNETIC SURVEYS ON SEA BY AIRCRAFT AND SHIP¹

Prepared by Yoshio Kato, Shinkichi Utashiro, Masayuki Matuo, Akio Takagi, Makoto Terajima and Miyoski Ito of Tohoku University and the Hydrographic Office of Japan

ABSTRACT

In accordance with the resolution adopted at the Eleventh General Assembly of the International Union of Geodesy and Geophysics (IUGG) in 1957, Japan's programme of magnetic surveys on sea has been carried forward.

For the aeromagnetic survey on sea, an air-borne magnetometer with saturable inductor was developed by the writers at Tohoku University and was used for practical surveys in the Boso District in February 1958, around the O Sima Island (Izu) area in July 1958 and in the Izu Syoto Islands in August 1959. The results of the first and second surveys have already been reported. The third survey was carried out by a Beachcraft No. 502 of the Maritime Safety Board, with flight elevation of 3,000

¹ The original text of this paper, submitted by Japan, appeared as document E/CONF 36/L. 12.

metres above sea level, measuring the vertical component of the earth's magnetic field to prove that the most remarkable anomaly was associated with volcanoes on the Izu Syoto.

For the magnetic survey at sea surface, a ship-borne magnetometer, also designed by the writers, was employed on the survey ship Takuyo, of the Hydrographic Office, around the Sagami Nada near Izu Hanto Peninsula in January 1960.

The heart of this magnetometer is a saturable inductor mounted on a gimbal system. In order to avoid magnetic disturbance by the vessel, the instrument was hung at a depth of about forty metres beneath the body. From results of the survey, two remarkable anomalies were observed around Ito and Okinoyama, respectively. It was found that the anomaly near Ito is associated with submarine volcanoes, and the anomaly around Okinoyama belongs to the submarine topographic configuration.

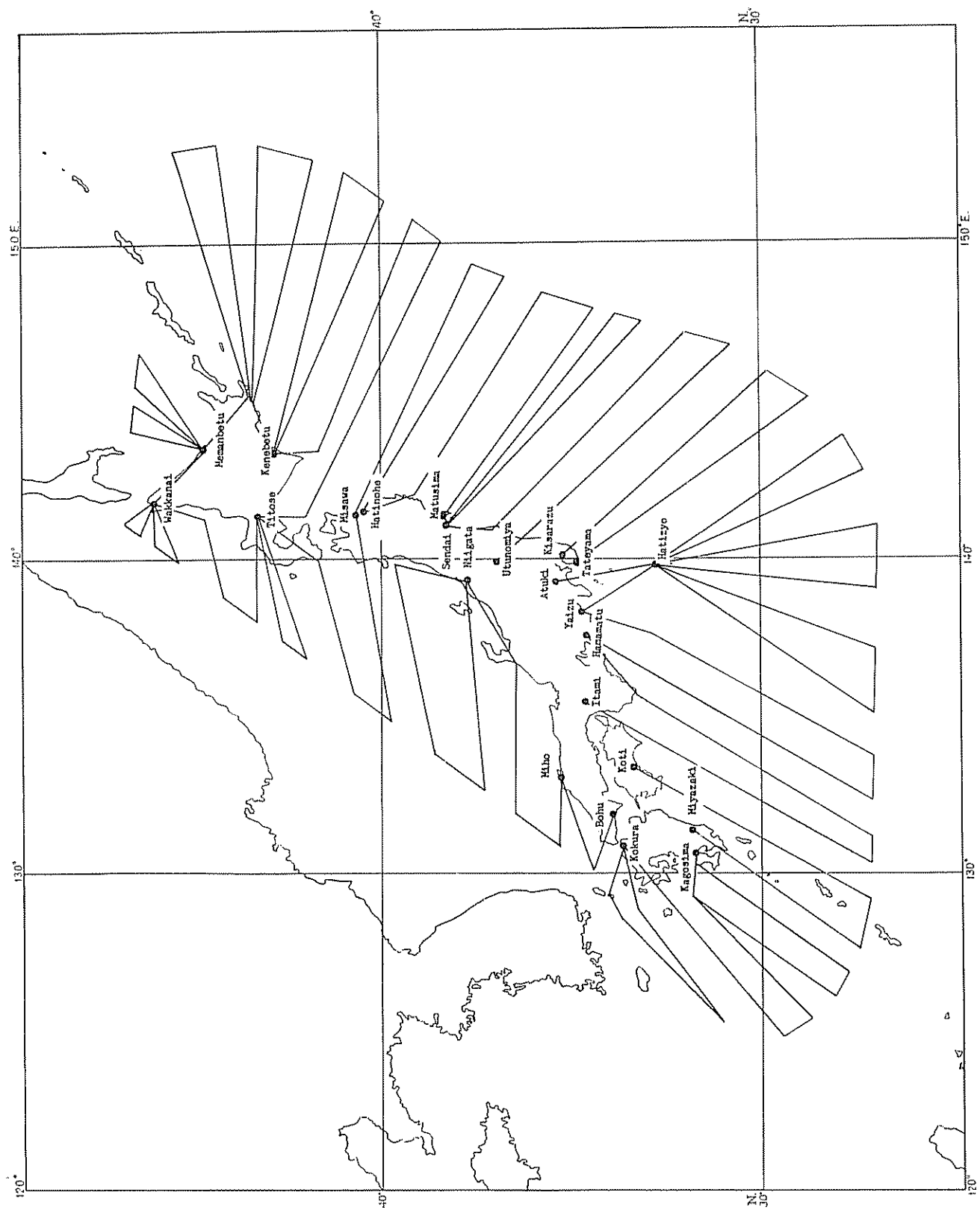

Figure 28. Japan: Plan of the aerial geomagnetic survey for the world magnetic charts

We also studied the magnetism of a steel vessel. In this paper, the general features of magnetic fields around an iron ship are investigated, especially from the standpoint of detecting them magnetically. The magnetic moment

of the steel vessel Takuyo was obtained from the results of a magnetic survey made around her body, the vessel being assumed to be a uniformly magnetized prolate spheroid.

Introduction

In order to investigate terrestrial magnetism and promote the safety of navigation, the magnetic survey over the whole of Japan has been carried out on land by the Hydrographic Office since 1912. The magnetic survey on sea was difficult, because we could not build non-magnetic vessels and instruments which would measure the earth's magnetic field at sea and we therefore could not prepare the real magnetic chart for the sea area.

The aeromagnetic survey was recently developed in the United States of America; at first, total intensity was observed in north-eastern Umnak, Alaska, and afterwards extensive surveys were made in some parts of the mainland of the United States, and in Alaska, Canada, Mexico and the Pacific Ocean.

The magnetic survey at sea was carried out from 1912 to 1927 by a non-magnetic vessel, the Carnegie, designed in the United States.

At the Eleventh General Assembly of the International Union of Geodesy and Geophysics, held in Toronto, Canada, in 1957, a proposal for co-operation for the World Magnetic Survey, especially on sea, was adopted. At present, magnetic surveys on sea are being carried out with a non-magnetic survey vessel, the Zaya, by the Soviet Union, and with a "R5D" aircraft with a NOL vector air-borne magnetometer by the United States.

In Japan, following the resolution adopted at the Toronto

Assembly, the programme of magnetic survey on sea has been carried out by the World Magnetic Survey Committee of the Science Council of Japan, and the Hydrographic Office has planned the schedules of the aeromagnetic survey on the adjacent seas of Japan. Following this plan, the aeromagnetic surveys were carried out in the Boso District and around the O Sima Island (Izu) area and the Izu Syoto Islands by the Hydrographic Office in co-operation with Tohoku University. Thus, the first magnetic sea chart in Japan was prepared. The results of these surveys were reported in part in previous papers (Kato, Matuo, *et al.*, 1958, 1959), and the result of the survey on the Izu Syoto is discussed in detail in part I of the present paper.

The magnetic survey at sea surface was made in Sagami Nada on the survey ship Takuyo (771 tons) of the Hydrographic Office. The instrument employed in this survey is the latest type of ship-borne magnetometer equipped with a saturable inductor, electronic oscillators, amplifiers, a recorder and a gimbal. The instrument was produced by the writers at Tohoku University. As a result of the survey, two remarkable anomalies were found near Ito and Okinoyama, and several interesting facts were also discovered (*see* part II of the present report).

We also measured a magnetic field around the Takuyo with the ship-borne magnetometer as described in part III.

I. Magnetic survey on sea by means of an air-borne magnetometer

PLANNING

The first magnetic survey was held in the Boso District in February 1958, and the second around the O Sima Island area in July of the same year. From the results of these surveys, it was discovered that there were remarkable anomalies near Ito, and that they were associated with a volcano. The third survey was carried out on the Izu Syoto in August 1959. The Izu Syoto is composed of a number of volcanic islands, including active, dormant and extinct quaternary volcanoes.

INSTRUMENT

The air-borne magnetometer which measures the vertical intensity of the earth's magnetic field, consists of a detecting mechanism, electronic oscillators, amplifiers, a recorder, a gimbal system and a vertical gyroscope. The heart of the air-borne magnetometer is a saturable inductor. This inductor consists of a core of easily saturable ferromagnetic material of high permeability (a very thin strip of permalloy) with an external winding coil to which is applied an alternating current by means of an electronic oscillator. Vertical intensity of the earth's magnetic field is measured by means of a coaxially-wound secondary coil around the saturable core. Because the saturable core inductor can measure the external field parallel to its axis, it can be used to measure the vertical component of the earth's magnetic field by setting an axis of saturable core parallel to the vertical direction. In our instrument,

attempts have been made to use a vertical gyroscope to orient the detector so as to measure the vertical component in aircraft. The gyroscope determines the true vertical in a moving vehicle. This system can keep the vertical within an accuracy of about ten minutes of arc in flying at an altitude of about 3,000 metres in smooth air.

The air-borne magnetometer enabled us to take measurements of the vertical component quite easily, and the instrumental error never exceeded 50 γ , which ensured sufficient accuracy for the survey on sea. Following are the details of this air-borne magnetometer.

If an external magnetic field, Z , which we must measure, is applied to the core, the field is increased during one-half of the cycle and decreased during the other half.

Then, the amplitude of the wave form of flux density becomes asymmetrical, because the so-called $B-H$ curve of the ferromagnetic core has a character of point symmetry. In other words, there is a proportional relation between the intensity of the magnetic field (Z) and the amplitude difference between positive and negative amplitudes of flux density. When a suitable and saturable alternating magnetic field (hereafter called the carrier) is driven to the primary coil of the ferromagnetic core, the output voltage of the secondary coil is proportional to the differentiated value of flux density with respect to time. The output electromagnetic-motive force of an integral circuit in an electrical device has a wave form for the time similar to that of the above-mentioned flux density.

But the constant term in the wave form of flux density is eliminated at the output of the secondary coil, for the output voltage is given as the differentiated value of the flux density with respect to time. Then, the output voltage of the integral circuit does not contain this constant term; therefore, it shows a wave form similar to that of flux density with respect to time. Then, it is considered that there is always a proportional relationship between the magnetic field and the difference in positive and negative pulse amplitudes of output electromagnetic-motive force of the integral circuit. Therefore, in order to obtain the best sensitivity, we used as a carrier wave the alternating pulse wave whose width was sufficiently narrow compared with its period.

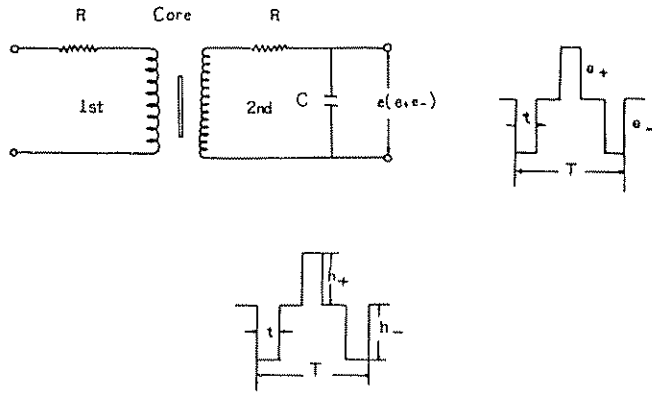

Figure 29. Schematic diagram of operation of the saturable inductor of the air-borne magnetometer

The simple circuit for the principle is shown in figure 29. The wave form of the carrier is illustrated in figure 30 where T is the period of alternating pulse wave, and τ and h are the width and the amplitude of it, respectively. Now, it is assumed that there is no hysteresis on the B - H curve of the ferromagnetic core, and magnetic characters of this magnetic core are represented approximately by three so-called straight-line segments:

$$B = \mu H \quad \text{for } |B| \leq B_m,$$

$$B = \pm B_m \quad \text{for } |B| \geq B_m,$$

- where $\omega CR > 1$ is the condition of integral circuit;
 μ is the effective permeability;
 B_m is the flux density at saturation;
 H_m is the minimum field intensity which gives the saturate flux density (B_m) in the core;
 $e(e+e-)$ is the output voltage of integral circuit;
 S is the effective area of the core;
 N is the total turns of secondary coil; and
 k is $10^{-8} SN/CR$ volt.

Figure 30 illustrates the general characteristics of the wave form of the flux density and the output voltage of an R - C integrator, when the carrier of the pulse wave, which the flux density produced in the ferromagnetic core becomes at saturation, is driven to the core and when an external magnetic field (ΔH), is superimposed on it.

As shown, the change of flux density with respect to time is expressed as follows. If we take the line X - Y as the time axis,

$$B(B_+, B_-) = B_0 + \sum_0^{\infty} B_n(\omega t + \phi_n),$$

it follows that

$$|B_+| \sim |B_-| = 2\mu |\Delta H|,$$

$$kB_0 = k \int_0^T B dt$$

The difference of two amplitudes of positive and negative in the output voltage of the integral circuit becomes

$$|e_+| \sim |e_-| = 2k\mu(1 - 2\tau/T) |\Delta H|,$$

then

$$|e_+| \sim |e_-| \doteq 2k\mu |\Delta H|,$$

where $2\tau/T < 1$.

This expression shows that the alternating pulse wave, whose width is narrow enough in comparison with its period, should be given as a carrier wave.

The value of $2\tau/T$ may be taken practically,

$$2\tau/T \doteq 1/10.$$

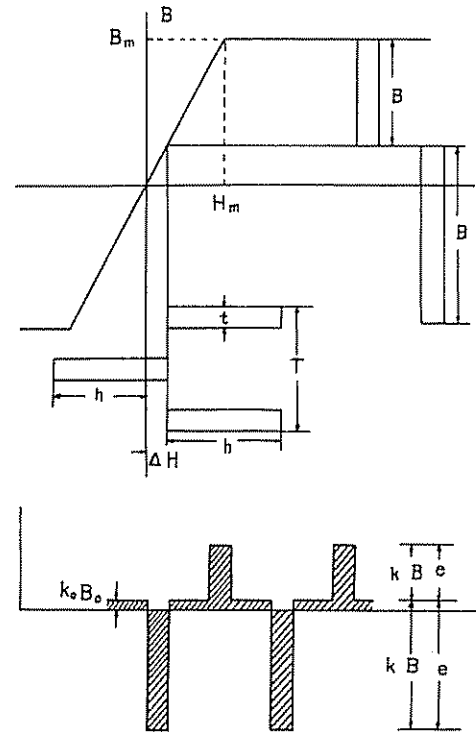

Figure 30. B-H curves of the ferromagnetic core of the saturable inductor of the air-borne magnetometer

The block diagram of the special-type variometer is illustrated in figure 31. In this variometer, two essentially identical ferromagnetic cores are fixed geometrically parallel to each other and the external winding connected differentially in order to eliminate odd harmonics of fundamental frequency and improve the modulation in magnetic detector. Even when there was no external magnetic field, the unnecessary output voltage would be generated by the imbalances in the amplitude and the phase of these cores.

It is clear that the unnecessary output voltage generated by the amplitude imbalance of the external windings of these two cores must be taken as being much larger than the phase difference. The primary and secondary coils are wound around the ferromagnetic core, whose diameter is one millimetre and length ten centimetres.

The ferromagnetic core consists of a strip of Mopermalloy 0.005 cm thick and 0.5 cm wide. The strip is rolled into a tubular form about 0.1 cm in diameter and 10 cm in length.

The eddy-current losses in the core become significant when the driven frequencies of the pulse reach about one

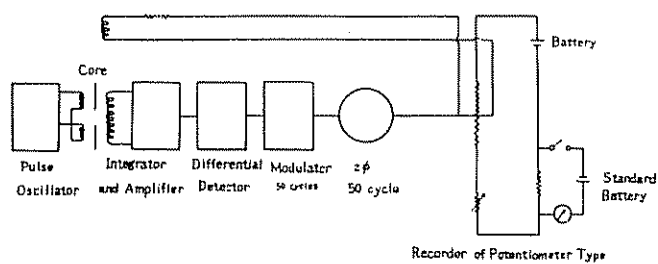

Figure 31. Schematic diagram of the air-borne magnetometer

kilocycle. In order to feed the driving current to the primary coil, a pulse oscillator of 120 cycles is used. The output voltage of the magnetic detector is transferred to the integral circuit and the integrated voltage is then amplified by the amplifier in the next stage.

In the differential detector, the output voltage of the amplifier is converted to direct current proportional to the difference between the positive and negative pulse amplitudes. The output of the differential detector is translated into an alternating voltage of fifty cycles by an additional modulator which drives a servomotor only when a difference exists in the positive and negative pulse amplitudes. In other words, the servomotor, by which the contact brush of the potentiometer is moved, cannot be driven by the output of the modulator when there is no signal in the system.

A part of the voltage in the potentiometer is fed back to the compensating coil, as shown in figure 31, then the external magnetic field (ΔH) and the magnetic field generated by the current which follows through the compensating coil always cancel each other automatically by this servomotor. And the intensity of the external magnetic field can be recorded visually on the recording paper by the recording pen which is moved automatically in connection with the contact brush of the potentiometer.

MAGNETIC SURVEY

The third aeromagnetic survey was carried out on the Izu Syoto with an air-borne magnetometer by a Beachcraft No. 502, the airplane of the Maritime Safety Board, from 16 to 20 August 1959. The flight pattern of the aeromagnetic survey is shown in figure 32. The flight elevation in this aerial survey was about 3,000 metres above sea level. The aircraft was able to fly smoothly because of the good flying conditions at that height. The pilots were guided on these flight patterns by an electronic indicator, Radio Beacon, that showed the position of the plane with respect to its present course. The altitude of the aircraft was determined by a barometric altimeter, which measures height above sea level. The vertical intensity obtained in this survey is shown in figure 33.

As can be seen in the figure, it was found that there

exists a remarkably large anomaly in the south-eastern area of Ito City. This anomaly is considered to be due to submarine volcanoes and a detailed description of it resulting from a magnetic survey by ship-borne magnetometer is given in the following section.

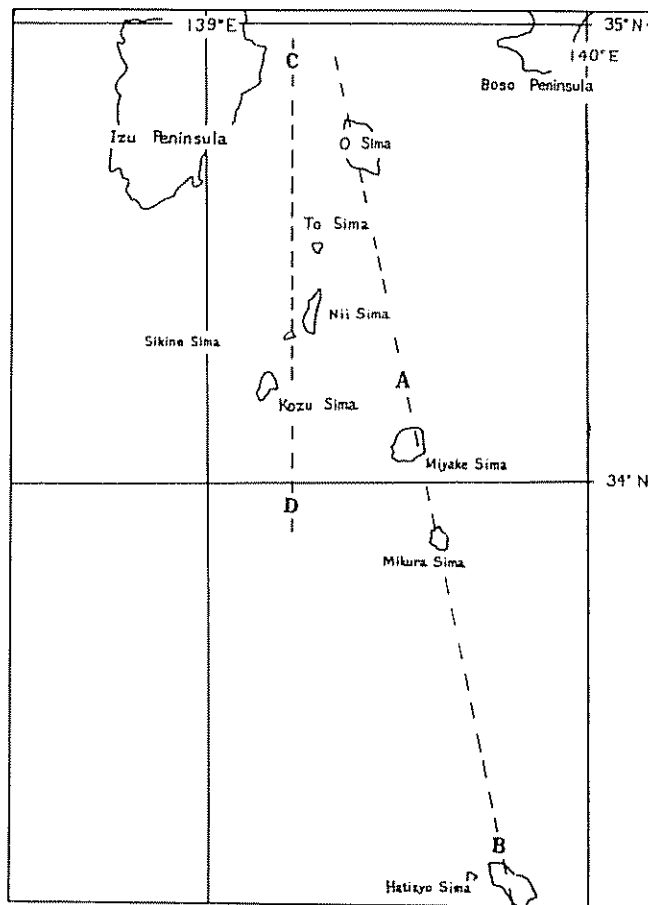

Figure 32. Flight pattern of aeromagnetic survey

The normal values of the vertical intensity on the Izu Syoto are then obtained from the Hydrographic Office magnetic chart No. 6024 for 1955. We obtained the intensity of the magnetic anomaly in figure 33 by using the normal value around the Izu Syoto.

Thus, local magnetic anomalies closely related to the structure of volcanoes have been found on many volcanic islands and on a marine volcano. It seems that these volcanic islands are constructed of basaltic rocks. Regarding geomagnetic surveys on volcanoes, one of the present writers (Y. Kato, 1956) carried out a magnetic survey on land at Miyake Sima Island. At the same time, we carried out an aeromagnetic survey on the island. Using the results of these magnetic surveys, we evaluated the depth of the dipole on Miyake Sima at about five kilometres.

In future, aeromagnetic surveys over the seas adjacent to Japan will be undertaken by the Hydrographic Office, forming a link in the chain of the world magnetic surveys of the IUGG.

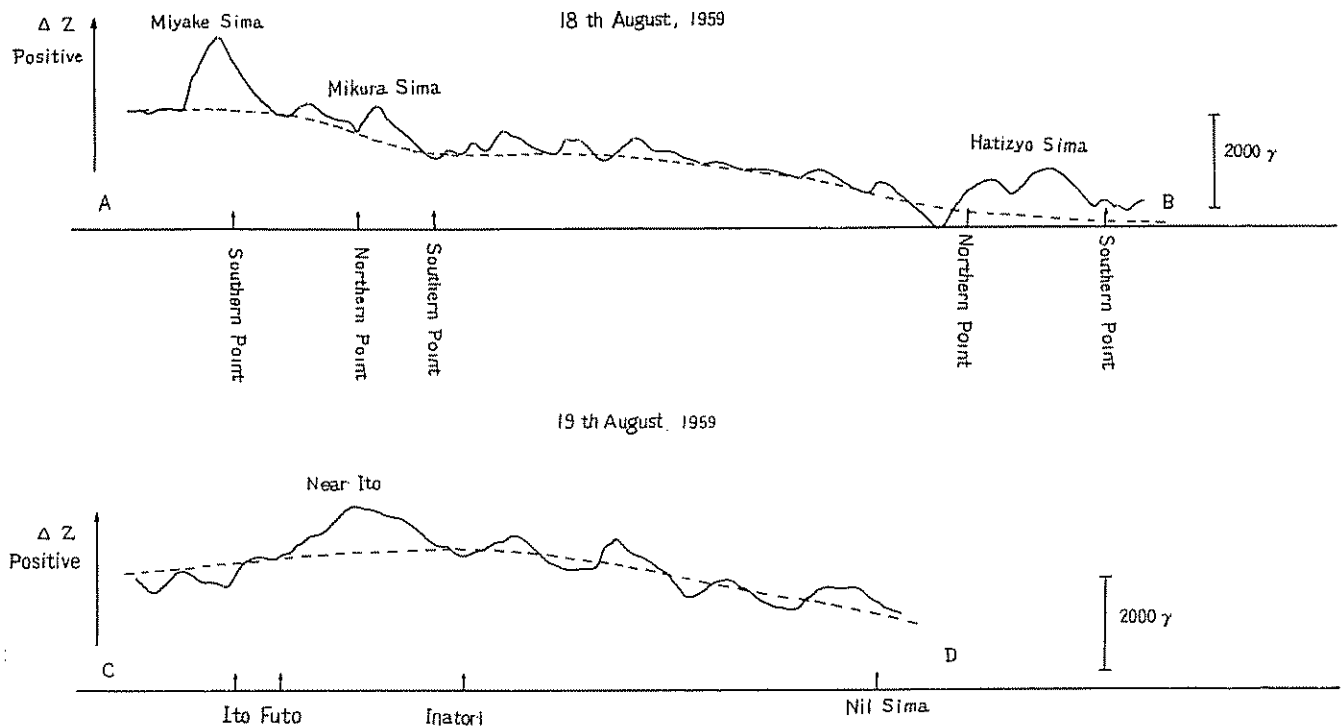

Figure 33. Results of the aeromagnetic survey in the Izu Syoto area

II. Magnetic surveying at sea by means of ship-borne magnetometer

PLANNING

It has been established that magnetic surveys carried out at sea by ship-borne magnetometer are very useful for investigating marine volcanoes and magnetic anomalies. It is clear that local magnetic anomalies at sea are closely related to the structure of volcanoes. As the airborne magnetic survey in 1959 indicated a local magnetic anomaly near the Ito District, the first magnetic survey by ship-borne magnetometer was carried out near there in January 1960.

The magnetometer, completely transistorized, was especially designed by the research group on ship-borne magnetometers at Tohoku University. The magnetometer is described in detail in the following section. A magnetic survey at sea was also carried out around Okinoyama in Sagami Nada by the Takuyo.

The portable ship-borne magnetometer enables us to take measurements of vertical intensity quite easily. Many good measurements can be carried out in a short time.

INSTRUMENT

The recent development of the saturable core magnetometer is a major advance in geomagnetic surveying. The heart of the ship-borne magnetometer is the saturable inductor, which measures the earth's magnetism independently of the velocity and acceleration of the vehicle. It consists of a core of easily saturable ferromagnetic material of high permeability (permalloy) with an external winding to which is applied an alternating current producing a magnetic field that drives the core cyclically through saturation.

If an external magnetic field, H , is also applied to the core and if the permeability, μ , of the core is high, the magnetic flux density, μH , produced in it by the external field is an appreciable part of the flux density at saturation, B_m . Owing to this effect of the core, the output electromagnetic-motive force of the coil will be distorted and will have an asymmetrical wave form containing both even and odd harmonics of the driving frequency. A schematic diagram of operation of the saturable inductor is shown in figure 34. Both even and odd harmonics are functions

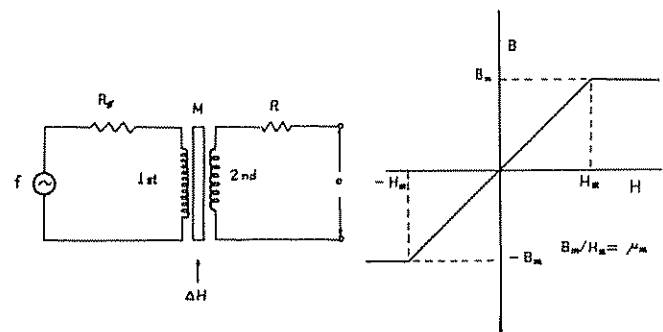

Figure 34. Schematic diagram of operation of the saturable inductor of the ship-borne magnetometer

of the external field, H , but only the even harmonics are sensitive to its sign and vanish when it equals zero. Therefore, measurement of one or more of the even harmonics of the output emf provides a means of measuring the external field. In this case, only one harmonic system

was employed to measure the external magnetic field. A diagram of this system is shown in figure 35.

This single harmonic system uses a single-element inductor and a narrow band-pass filter that excludes all harmonics but the desired frequency (the second harmonic) of the output emf. The major portion of the earth's field acting on the detector coil is nullified by a magnetic field produced by means of a steady direct current flowing

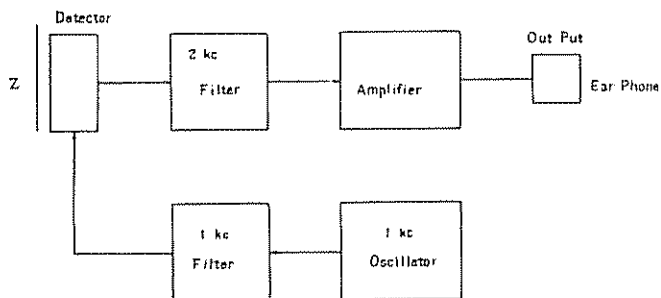

Figure 35. Schematic diagram of the ship-borne magnetometer

through a coaxial secondary winding around the saturable core.

Thus, instead of measuring the earth's vertical field, this equipment measures the intensity of a steady direct current flowing through a nullified coil controlling an electrical resistance. Because the saturable inductor measures the external field parallel to its axis, it can be used to measure the vertical component of the earth's magnetic field. In this instrument, an attempt was made to use a gimbal system to orient the detector so that the vertical component could be measured at sea.

The gimbal system mounted in the case of the magnetometer determines the true vertical line at sea. If the angle of roll of a ship-borne magnetometer due to waves is about 20° , the error of measurement never exceeds 50γ . The detector and gimbal system are set in a bomb-shaped nacelle. This detector mechanism must be located so that it is not affected appreciably by the magnetic material of the ship.

The magnetometer may be used by moving the detector mechanism from the ship and hanging it by means of a winch and cable system in the sea. The towing cable consists of the necessary electrical conductors and nylon rope.

ASSOCIATED EQUIPMENT

The ship-borne magnetometer measures the magnetic vertical intensity of each point at sea. The position of the ship was fixed by electronic navigation aids, such as Loran, or by sextant.

The depth of the ship-borne magnetometer was determined by scale from sea level. The depth of sea bottom at each observed point was measured by an echo sounder. All necessary data to compile a magnetic chart were measured frequently so that the magnetic intensity could be determined at each point.

MAGNETIC SURVEY

The most efficient pattern for surveying is a series of parallel traverses taken at right angles to the trend of the major magnetic anomalies. Since this trend is not known until the survey is well under way, and a magnetic anomaly

is magnetized in the direction of the earth's magnetic field, the course measured must be crossed by two traverses, one parallel to a magnetic meridian and the other perpendicular to it. The observed points are shown in figure 36. The survey was carried out on Sagami Nada by the Takuyo from 20 to 26 January 1960.

Since, in magnetic surveys, the effects of the diurnal variation of the earth's magnetic field and the instrumental

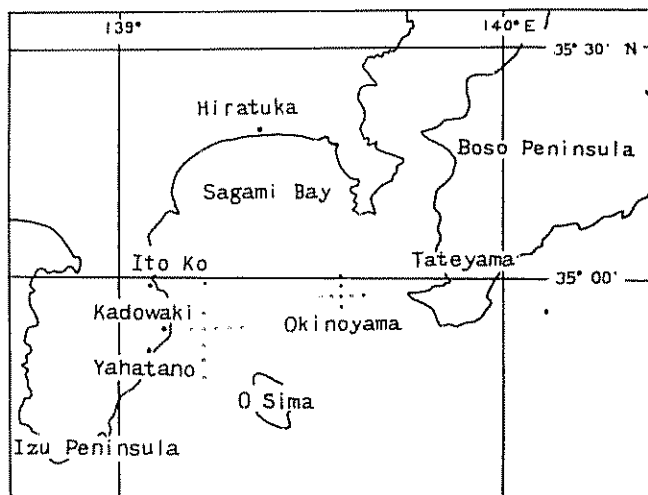

Figure 36. Distribution of measuring points of magnetic survey

drift are very small, these effects can be ignored when measuring a magnetic field within an error of about 50γ . The necessary time duration to measure a magnetic field at any point is about twenty minutes, and the measurements are carried out at a depth of about forty metres where they are not influenced by the magnetic materials of the ship. The morphology of a magnetic anomaly is determined by drawing an average smooth curve through the observed values. The smooth curve is calculated by the least squares method.

The results of the magnetic survey could be used to supply a unique or more accurate determination of the depth of the material producing the magnetic anomaly.

Figure 37 shows the results of this survey, from which it was found that there are two pronounced anomalies, one near Ito, the other around Okinoyama at Sagami Nada. The anomaly near Ito is very great, the one at Okinoyama less so.

The analysis of these anomalies is shown in the following section. Assuming that the magnetic field of anomaly is caused by a dipole underground, and taking the dipole as the origin of co-ordinates and its depth as d , we get the vertical component of the magnetic anomaly due to the dipole, as follows:

$$Z = 3 M_2 \left[\frac{-d}{r^3} \left(x - d \frac{Z_0}{H_0} \right) \frac{H_0}{Z_0} - \frac{1}{3r^3} \right],$$

where M_2 represents the vertical moment of the dipole. The distribution of vertical intensity by the anomaly is shown in figure 38, where the magnetic inclination in the adjacent Sea of Japan is taken as approximately 45° , namely $H_0 = Z_0$. Comparing figure 37 with figure 38, we can easily obtain the magnetic moment and the depth of the dipole.

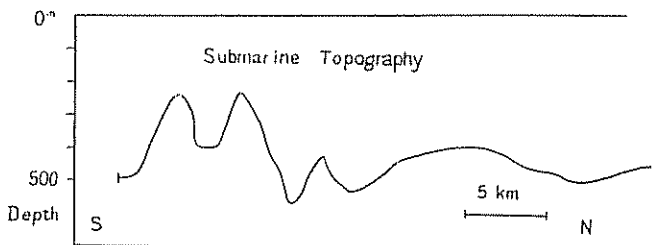
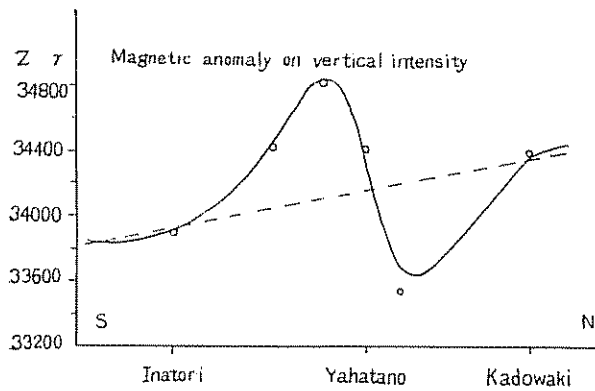

A

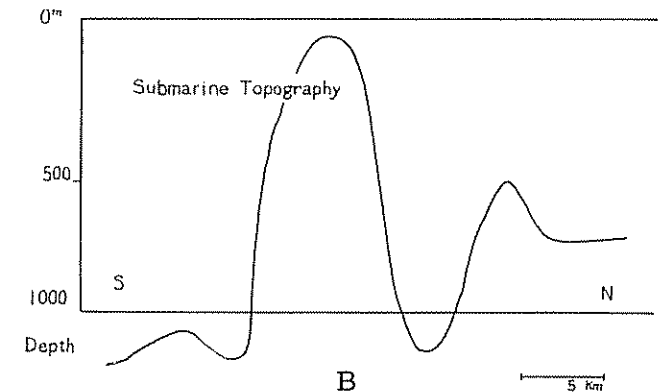
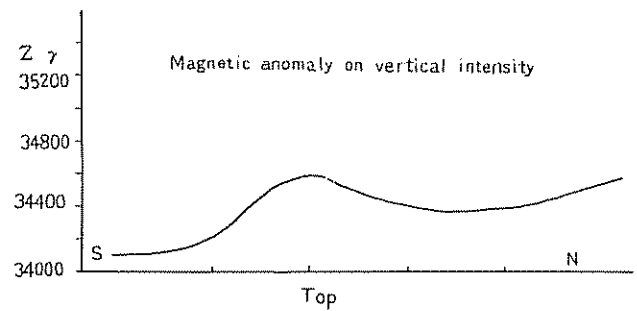

B

Figure 37. Magnetic anomalies and submarine topography

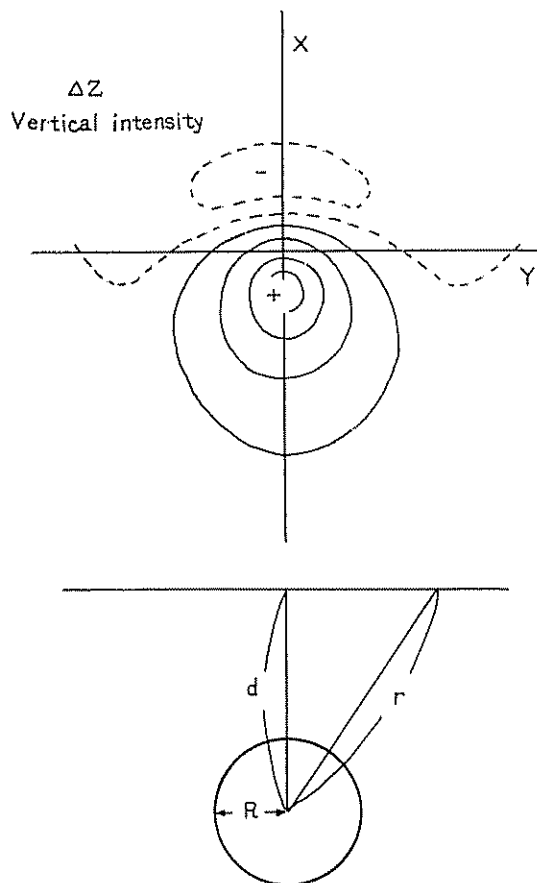

Figure 38. Distribution of a magnetic anomaly due to an underground dipole

If we assume the dipole to be produced by a uniform magnetized sphere of radius R , the effective intensity of magnetization is expressed as

$$M = \frac{4}{3} \pi R^3 J.$$

As shown in figure 38, the area shows a large positive anomaly in the south, and a small negative anomaly in the north.

In the case of the anomaly near Ito, the depth of the dipole is about two kilometres and the magnetic moment is 2.4×10^{14} emu.

Therefore, we can consider that the anomaly may be caused by a large underground mass of basaltic rock. The intensity of magnetization is listed in table 1, assuming the dipole to be due to a uniformly magnetized sphere of radius $R = 2$ km. It seems that there is no apparent correspondence to the submarine topography near Ito.

This suggests that the magnetic field is more seriously affected by the magnetic properties of the materials near the surface of the earth than by the submarine topography. Also, it can be assumed that this magnetic anomaly is associated with a submarine volcano.

Table 1. Magnetization and magnetic moment of an anomaly near Ito and one at Okinoyama

Position	J emu/cc	Magnetic moment	Rock
Near Ito	0.035	2.4×10^{14} emu	Basalt
Okinoyama	2×10^{-5}	5.4×10^{11} emu	Shale

In the case of the anomaly at Okinoyama, we can calculate the magnetic moment by the same method described for that near Ito. The results are shown in table 1.

From the chart and the profile of the submarine topography shown in figure 37B, we can see that Okinoyama has the structure of a bank. Therefore, the magnetic anomaly at Okinoyama may be due to the remnant magnetization of the mass of the bank caused mainly by the earth's magnetic field. Assuming that the dipole is situated at the centre of the bank, and that the anomaly is due to the remnant of magnetization of the mass of the bank, its depth, intensity of magnetization and magnetic moment can be calculated as follows:

Depth about 0.6 km
 M 5.4×10^{11} emu
 I 2.0×10^{-5} emu/cc

The results are also shown in table 1.

It can be concluded that the anomaly is a magnetic one, due largely to the uniform magnetization of the bank below sea level with its intensity of 2.0×10^{-5} emu/cc in the direction of the earth's magnetic field. Thus, it is found that the bank at Okinoyama is formed of sedimentary rock.

III. Magnetism of a steel vessel

MAGNETISM OF A STEEL VESSEL

The detailed measurement and analysis of the magnetic field existing on a steel vessel are studied in this section. The magnetism of a steel vessel arises largely from the induced and permanent magnetisms on the vessel.

A permanent magnetism can be considered as a concentrated dipole and the intensity depends on the magnetic heading upon which the vessel was built.

An induced magnetism can be treated as if it were concentrated in bars of soft iron, one vertical and the other horizontal. The polarity of a steel vessel depends upon the position of the vessel relative to the earth's magnetic field, and the strength depends upon the strength of the vertical and horizontal components of the earth's field.

The magnetic fields around an iron ship were calculated by J. Ohshima (1955), the ship being assumed to be a uniformly magnetized prolate spheroid. From the results, a simplified diagram of the distortion of the earth's field in the vicinity of a steel vessel is shown in figure 39. A vessel's induced magnetism varies with its heading.

The total magnetic moment of a vessel may be divided into three components: (1) vertical, (2) horizontal, fore and aft and (3) horizontal athwartships. The magnetic moment of a steel vessel may be separated into two parts: induced magnetism and permanent magnetism.

MEASUREMENT OF THE MAGNETIC FIELD AROUND THE TAKUYO

The magnetic measurement was carried out on the Takuyo, at Tateyama Bay on 26 January 1960.

At first, the vessel was directed on a heading of magnetic north, then on a heading of magnetic south. In each direction, the vertical component of the magnetic field around the vessel was measured with the ship-borne magnetometer along the horizontal fore and aft direction of the vessel at various depths below sea level, for example, 15, 20, 25, 30, 35, 40 and 45 metres.

The relation between the vertical intensity of the magnetic field of the Takuyo and the observed depth is shown in figure 40. Comparing figure 39 with figure 40, we can calculate each component of the magnetic moment of the Takuyo on the permanent and induced magnetisms, which are listed in table 2.

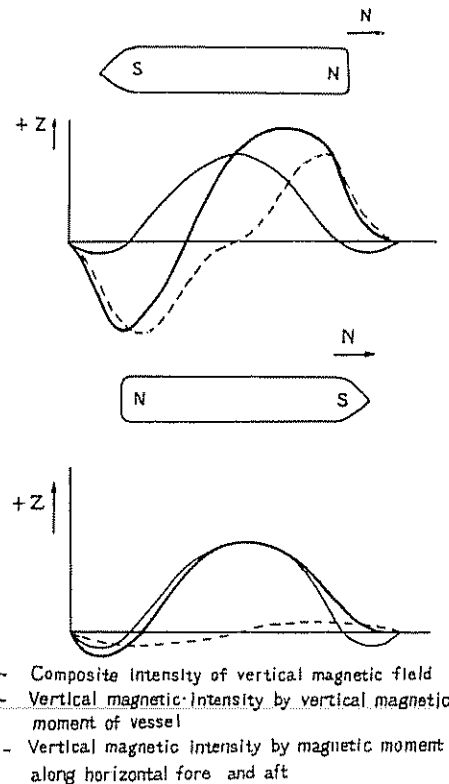

Figure 39. Theoretical distribution of the vertical magnetic field of a steel vessel

Table 2. Magnetic moment of the Takuyo

Magnetic moment	Horizontal fore and aft component	Vertical component
Permanent magnetic moment	4.2×10^7 emu	5.4×10^7 emu
Induced magnetic moment	4.2×10^7 emu	3.0×10^7 emu
Total magnetic moment	8.4×10^7 emu	8.4×10^7 emu

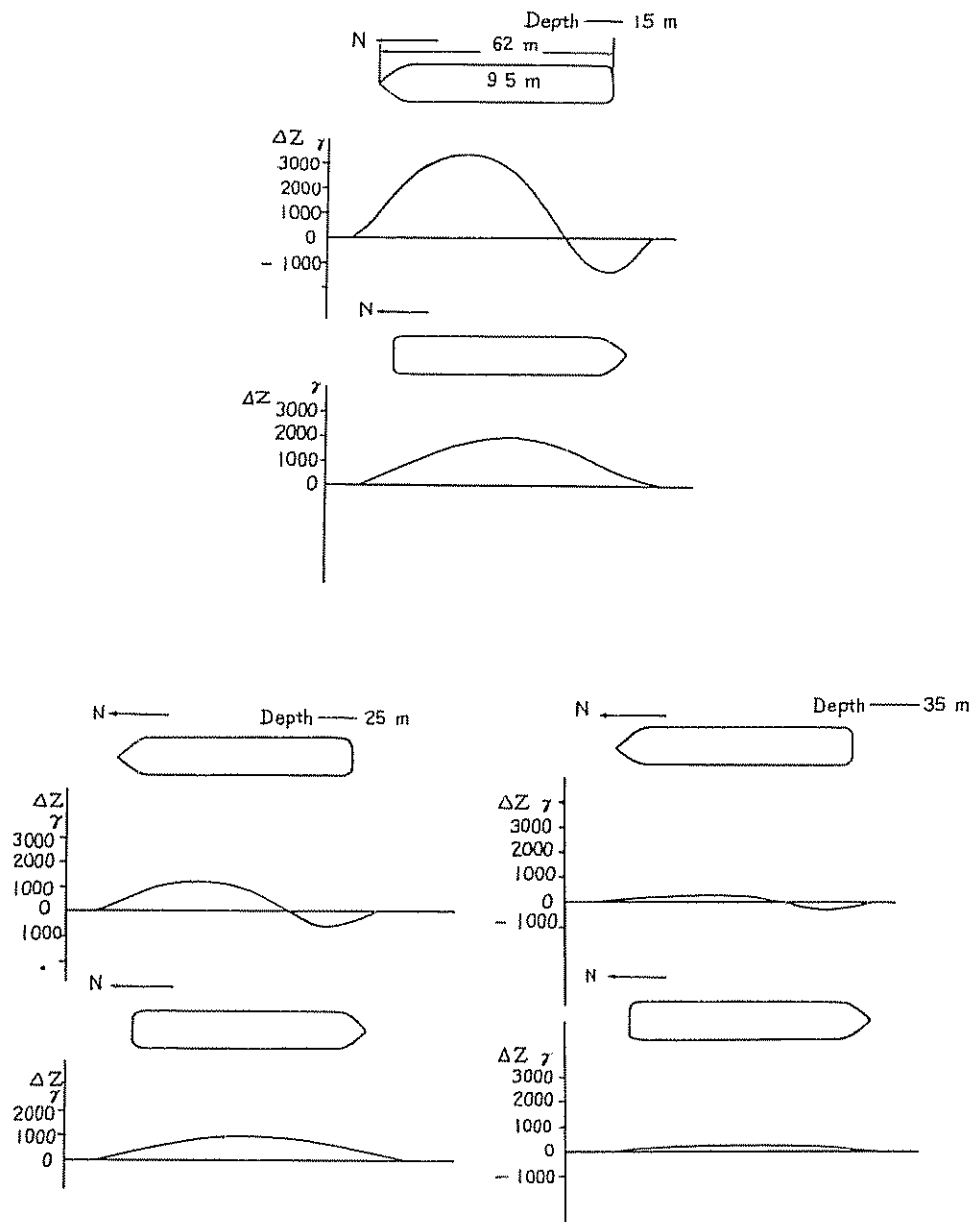

Figure 40. Relation between the magnetic field of the Takuyo and depth

Conclusion

We carried out geomagnetic surveying with the new type of magnetometer by means of an aircraft and a vessel on a volcanic island and at sea, and obtained interesting results. Also, we measured the geomagnetism of a steel vessel, and calculated each component of the magnetic moment of it.

In future, such magnetic surveys will be carried out in many areas of the seas adjacent to Japan for the investigation of terrestrial magnetism and for the promotion of the safety of navigation.

REFERENCES

Jeans, J. H., *Mathematical Theory of Electricity and Magnetism*, pages 273 and 274.

Kato, Y., *Sci. Rep. Tohoku Univ. Ser. 5, Geophy.*, 1956, No. 6, pages 15 to 19.

Kato, Y., Matuo, M., Sakurai, A., Tagaki, A., Kawamura, B and Sugiura, K., *Hydrographic Bulletin*, 1958, No. 57, page 15.

— loc cit., 1959, No. 60, page 7.

Landsberg, H. E., *Advance in Geophysics*, 1952.

Muffly, G., *Geophysics*, 1947, page 321.

Hydrographic Office, M. S. B., *Bulletin of the Hydrographic Office*, 1960, v. 14.

Oshima, J., *Simadzu Review*, 1955, 10:162-174.

Stockard, H. P., *International Hydrographic Review*, 1956, v. XXXIII, No. 2.

Yokoyama, I., *Bull. Earthqu. Inst., Univ. Tokyo*, 1957, 35:327-358.

Yukutake, T., loc. cit., 1960, 38:41-54.

BACKGROUND PAPER BY THE UNITED STATES COAST AND GEODETIC SURVEY AND THE UNITED STATES NAVY HYDROGRAPHIC OFFICE¹

Magnetic variation (declination) charts for the 1960 epoch were published at the beginning of 1960 by the Navy Hydrographic Office. In addition to small-scale charts providing world coverage as in the past, a set of twelve larger-scale charts covering the world from 84° N latitude to 79° S latitude on a Mercator projection were issued. To facilitate grid navigation in the polar regions, the series also included charts of the north and south polar regions on a polar stereographic projection portraying the direction of magnetic north relative to the selected rectangular grid. All magnetic variation charts are overprinted with current isoporic (annual change) curves.

These charts were compiled by the Coast and Geodetic Survey. An interesting report on the survey processes and correlation of observations as applied in the development of these charts was included in pages 47 to 51 of the July 1961 edition of *The International Hydrographic Review*. This report, "The variation of the compass for the year 1960" by Albert M. Weber and David G. Knapp of the Coast and Geodetic Survey, provides information supplementary to this paper. For the first time, the lines have been compared and co-ordinated with those of the corresponding chart compiled by the Astronomer Royal of Great Britain. The Coast and Geodetic Survey also published the isogonic chart of the United States which included the states of Alaska and Hawaii for the same epoch. These charts show, as usual, the distribution of magnetic declination and of its annual change, and the locations of magnetic observatories. Another chart was prepared to show the magnetic declination in the Great Lakes area; this was printed and is distributed by the United States Lake Survey. Finally, a set of 1:5,000,000 charts, one encompassing Mexico, Central America and the West Indies, and the other two together covering South America, are being published by the Army Map Service.

The new charts incorporate much new data in some areas, such as the North Atlantic Ocean, and reflect marked changes in the isoporic patterns in other areas, such as the Caribbean and the South Atlantic. The region of eastward change centred over the Mediterranean has expanded to include much of the South Atlantic. At the same time, the South American focus of westward change, though retreating from the Atlantic, seems to have intensified somewhat in the Brazil-Peru region, and it has spread to the north so as to increase the change rates substantially as far north as the Gulf of Mexico.

A programme of research and development has recently been undertaken by the Navy Hydrographic Office and the Coast and Geodetic Survey directed towards more effective methods of data reduction and analysis, and the production of more accurate and analytically consistent charts.

A large part of the new data for the world charting programme has come from a world-wide air-borne magne-

tic survey being conducted by the Navy Hydrographic Office. This survey programme is being carried out by two specially configured aircraft, with instrumentation to measure all components of the earth's magnetic field. Survey tracks consist essentially of a series of round-the-world flights spaced approximately 320 kilometres apart. Although the primary purpose of this survey is to provide urgently needed magnetic data over the oceans, survey operations will include the polar regions as well as continental areas that must be traversed. The initial world-wide survey is expected to be completed in time to provide data for the next series of magnetic charts of all elements of the magnetic field to be issued for epoch 1965. After that, a system of repeat surveys will be carried out to maintain world geomagnetic data accurate and up to date.

Another step forward in magnetic survey work is the use of portable recording instruments to improve the reduction to epoch of repeat observations on land.

The expanded operations of the International Geophysical Year were carried out as planned and the resulting data are still flowing to the World Data Centres as their reduction and processing are accomplished. The United States programme included an important group of stations operated by the Scripps Institution of Oceanography in the Line Islands of Polynesia.

The station at Guam has been continued by the Coast and Geodetic Survey as an addition to its network of permanent observatories. Magnetic work at Byrd Station and the South Pole (Amundsen-Scott) station is likewise being continued under the United States Antarctic Research Programme. Wilkes Station has been turned over to New Zealand agencies. The rapid-run equipment at Fredericksburg, Tucson, Honolulu, Sitka, College and Barrow is being continued in operation.

Instrumental advances reported include a variable-area magnetograph recorder using 70-mm film, a proton vector magnetometer capable of great accuracy, another proton precession instrument for following changes in dip and declination, a towed-fish magnetometer for the study of off-shore magnetic field patterns and an alkali-vapour magnetometer which is proving suitable for space exploration in regions of very weak field.

Institutions that have contributed to observational geomagnetism, besides those already mentioned, include the Carnegie Institution of Washington, the United States National Bureau of Standards, the United States Air Force Cambridge Research Center, the United States Army Signal Research and Development Laboratory, the United States Geological Survey and the High Altitude Observatory of the University of Colorado. Research activities have been conducted by some of these agencies and also by the California Institute of Technology, the University of Alaska, the Applied Physics Laboratory of Johns Hopkins University, the Naval Ordnance Laboratory, the Naval Research Laboratory, the National Aeronautics and Space Administration and the University of Maryland.

¹ The original text of this paper, submitted by the United States of America, appeared as document E/CONF 36/L 38.

AGENDA ITEM 12

Hydrography and oceanography

(a) Review of new techniques and developments

ACTIVITIES OF THE HYDROGRAPHIC OFFICE OF JAPAN, 1958-1961¹

Background paper prepared by the Hydrographic Office, Maritime Safety Board of Japan

GEODESY

Astronomy

Photoelectric and visual observations of occultation of stars by the moon are being continued at headquarters in Tokyo (30 cm reflector) and at three hydrographic observatories, Sirahama (34° 43' N, 138° 59' E; 25 cm reflector), Simosato (33° 34' N, 135° 57' E; 15 cm reflector) and Kurasaki (34° 35' N, 133° 46' E; 30 cm reflector). Data were obtained from 453 stars in 1958, 450 stars in 1959, 426 in 1960 and 173 from January to June 1961. The reduction of the data yields the following values of correction to the moon's longitude, and $\Delta T +$ Ephemeris Time-Universal Time.

<i>Epoch</i>	ΔL	ΔT
1956.5	— 3".66	31".75 ± 0".16
1957.5	— 4".38	31".53 ± 0".20
1958.5	— 4".41	32".57 ± 0".13
1959.5	— 4".43	33".65 ± 0".15

In order to connect Japan geodetically with the continents of America and Asia, observations are in progress of occultations on the equal lunar limb line which passes through Japan and some islands in the Pacific Ocean. Sikoku and Wake Island were connected on 29 May 1958, and Sikoku and the Marcus Islands on 17 April 1959.

Contact times of an annular eclipse on 19 April 1958 were observed photographically at Ao-ga Sima, Takara Sima and Amami O Sima off the southern coasts of Japan. At Ao-ga Sima, the variation of geomagnetism during the eclipse was also observed.

For the total eclipse on 12 October 1958, observers were dispatched to Suwarrow Island (13° 15' S, 163° 6' W), near New Zealand, under the programme of the Solar Eclipse Committee of the Science Council of Japan. They succeeded in observing photographically the total light of the solar corona and the contact times, using a newly constructed device which could take twenty photographs of the photosphere of the sun per second, 10 centimetres in diameter, with driving film of 18 centimetres width having a speed of 10 centimetres per second.

Observations of the contact times and the corona of a total eclipse will be carried out at Lae, New Guinea, on 4 February 1962, with specially designed equipment.

¹ The original text of this paper, submitted by Japan, appeared as document E/CONF.36/L.61.

As a part of the national project of outer space research, the observation of earth satellites and rockets for geodetic purposes is being planned; some new equipment is now being designed for the purpose.

The Japanese Ephemeris, Nautical Almanac and Abridged Nautical Almanac are computed and published annually. Sight reduction tables and nomographs for navigation are also compiled and published. Altitude-Azimuth Almanacs have been compiled especially for the Antarctic Expedition.

Levellings and subsidence investigations

In order to secure the chart datum and investigate land subsidence, levellings were made at nine harbours, including Osaka, Yokohama and Niigata, from 1958 to 1960, and are to be made at four more in 1961.

The data have revealed a considerable number of subsidences. Particularly for the harbour district of Niigata, which suffers from a sinking in land area, precise soundings have been made to reveal the subsidence of the sea bottom. It has been found that the depths have increased about two metres in the past five years, which is approximately the same as the subsidence observed on land. Soundings are to be made at the other harbours for the same purpose.

For the sake of over-sea levelling, the refraction of light near the sea surface has been investigated, with particular emphasis on abnormal refraction. Intensive experiments were made in 1959 and 1961. Incidentally, it seems possible that the mechanism of heat exchange between air and water may be revealed through this study. The experiments are to be continued.

Gravimetry

In co-operation with the Department of Geophysics of Tokyo University, a marine gravimeter mounted on a gimbal with an auto-levelling device was tested on the survey ship Takuyo off the southern coast of Honsyu in January 1960. Meanwhile, in August 1961, a gravimetric survey was carried out successfully in the sea areas off the south-eastern coasts of Honsyu and Kyusyu with a marine gravimeter mounted on a vertical gyroscope.

The main part of the gravimeter is a short-period pendulum whose frequency is compared four times per second with a standard from a quartz oscillator, so as to exclude the influence of sea waves. This apparatus will be employed in the International Indian Ocean Expedition from 1962 to 1963 and in the gravimetric survey in the adjacent seas of Japan as a part of the Upper Mantle Project after 1963.

Geomagnetism

From 1958 to 1960, a new series of 1:10,000,000 magnetic charts was prepared and published showing variation, horizontal intensity and dip as of 1955.0 with their respective annual changes. These charts were compiled from the data obtained through the Sixth Magnetic Survey of Japan from 1954 to 1955.

The seventh Survey of Japan was carried out with the Hydrographic Office-type magnetometer from 1959 to 1960 at sixty-six stations with intervals of about 100 kilometres to revise the series of magnetic charts as of 1960.0. Among them, the chart of variation will be published in November 1961, while those of horizontal intensity and dip as well as a secular variation chart will appear, with detailed descriptions, in the forthcoming volume of the *Bulletin of the Hydrographic Office*.

In 1958, local magnetic surveys were carried out with the Askania variograph and the Hydrographic Office-type magnetometer at Ao-ga Sima and Tori Sima of the Izu Syoto Islands, south of Honsyu, Okusiri Sima, near Hokkaido, Iki Sima, near Kyusyu, and Simabara Hanto Peninsula on the western coast of Kyusyu.

In 1958, an air-borne magnetometer for vertical components was devised and was employed in the first aerial geomagnetic survey of O Sima and Sagami Nada Gulf off the southern coast of Honsyu. The second survey was carried out with a magnetometer for total components in Sagami Nada in 1958, followed by the third and fourth surveys around Izu Syoto in 1959 and 1960, respectively.

In accordance with the resolution on the world magnetic survey adopted at the Eleventh General Assembly of the International Union of Geodesy and Geophysics (IUGG) in 1957, an aerial survey will be carried out from February 1962 for about 9,000 nautical miles covering the sea areas 300 nautical miles off and around Japan, with a new instrument which is in preparation. The instrument consists of a magnetometer with a saturable core inductor of permalloy. The accuracies of this device are expected to be 0.1° both in declination and dip, and 50γ in each component of intensity. For azimuth fixing a fish-eye camera is to be applied.²

Marine magnetism was surveyed with the Tohoku University-type ship-borne magnetometer on the Takuyo, and a magnetic anomaly of about 1,000 γ was discovered on the extension of the volcanic chain of Mt. Fuji. In August 1961, magnetic surveys were carried out on sea-mounts and on a volcano near Kyusyu.

At the Simosato Hydrographic Observatory, about 130 kilometres south-east of Osaka, as part of the IGY and IGC observations, earth magnetic variations have been observed with an ordinary magnetograph (H, Z, D) and an induction magnetograph (dH/dt, dZ/dt, dD/dt).

In the International Indian Ocean Expedition, geomagnetism on the sea will be observed with a ship-borne and/or a proton magnetometer on the Takuyo.

OCEANOGRAPHY

Tides

Nineteen tide stations are being maintained along the coasts of Japan to keep tide prediction and chart data accurate and to investigate extraordinary tidal phenomena and ground subsidence. At these tide stations the surface temperature of water is also observed.

² See figure 28 and documents E/CONF.36/L.11 and L.12 reproduced in the present volume under item 11 of the agenda.

From 1958 to 1960, observations of tidal currents were carried out twenty-four hours a day at 681 stations, and long observations up to fifteen days were made at five stations to evaluate the harmonic constants of the tidal currents. In 1961, tidal currents will be observed at about 200 stations. The self-recording instruments employed were electric currentmeters as well as the Ekman-Mertz apparatus. Tidal current charts are compiled from the data obtained in these observations, and appear in some hydrographic publications.

Volume transports of currents are also observed through electric current of sea water induced by geomagnetism with the potentiometer attached to a submarine cable terminal laid in a channel or in the mouth of a bay. The investigation of change of volume transport is carried out at the mouth of Tokyo Wan Bay, in particular, as a part of the research project for the prevention of typhoon disasters in Tokyo.

Tide tables are published annually; tide predictions for sixty-two ports and current predictions for fourteen areas as volume 1, and for other ports and areas as volume 2.

A Doodson-Légé tide predicting machine was installed in 1959 in place of a Kelvin-type tide predictor.

Oceanographic observations

In order to investigate the mechanism of seasonal variations of oceanic currents, BT and GEK observations are now made quarterly at 961 and 5,448 spots, respectively, as well as oceanographic observations at 996 spots in areas around Japan. The results obtained from these regular observations, together with those by other organizations, are published quarterly as charts of the oceanographic states of the seas adjacent to Japan. (See figures 41 and 42.)

In 1959, investigations on the origin of Kuroshio and on its short-period changes were carried out in the areas between Kyusyu and the Philippine Islands and around Izu Syoto, respectively. From 1957 to 1959, observations of underwater currents and of steric sea level were made as part of the IGY project. A simultaneous observation of oceanic equatorial currents was also made under the same project, in co-operation with several countries. Other oceanographic observations have been made on the Soya on her annual voyages to the Antarctic.

Notification on oceanic currents recommenced in April 1960, through civil broadcasts and telegrams to navigators. The data employed are obtained from the appropriate current observations, mainly on Kuroshio, which are regularly taken twice a month.

Investigations on sea ice are made by survey ships and airplanes in the Okhotsk Sea each winter. Contamination of sea water and bottom sediments due to radioisotopes are investigated in ports, offshore regions and on the bottom of the Japan Trench.

As a part of the International Indian Ocean Expedition projected by the United Nations Educational, Scientific and Cultural Organization (UNESCO) and the Scientific Committee on Oceanographic Research (SCOR) of the IUGG, an oceanographic observation will be carried out in the eastern part of the ocean on the Takuyo from November 1962 to March 1963. The whole navigation distance exceeds 17,000 miles. The observation covers the following branches: serial water sampling, BT measurement, chemistry, inclusive of radioisotope analysis, current measurement inclusive of GEK, meteorology, biology,

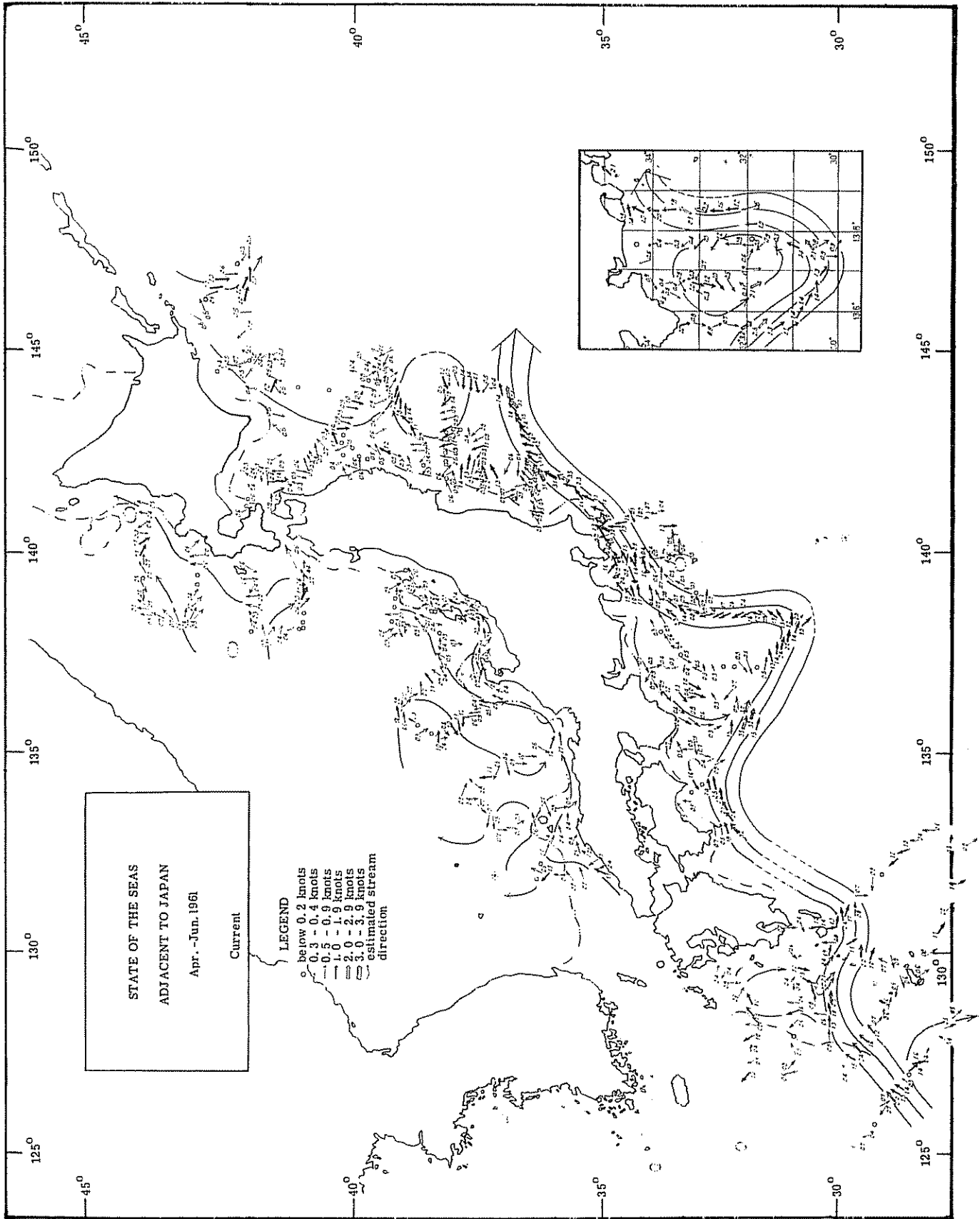

Figure 41. Chart of oceanographic observations of the seas adjacent to Japan—I

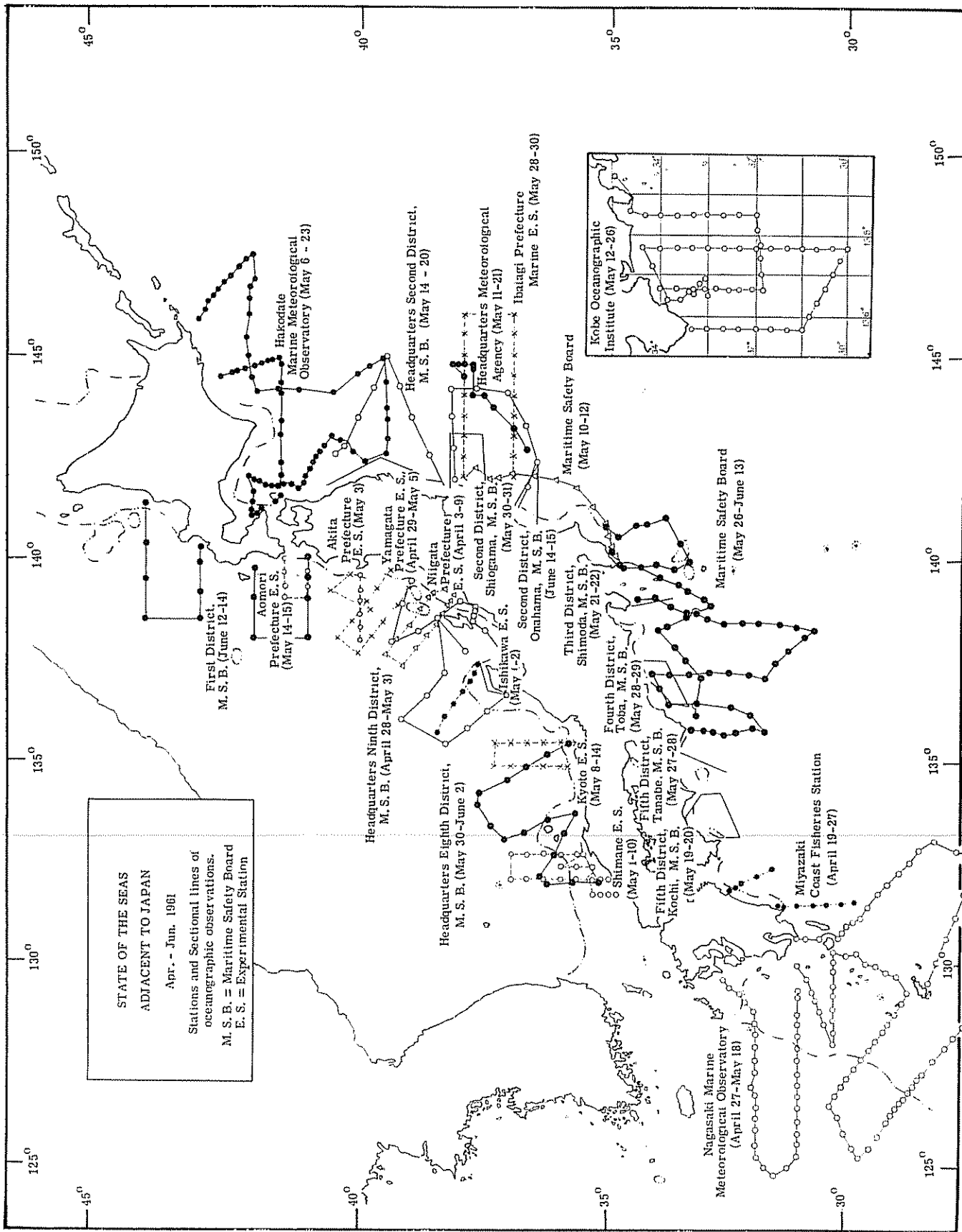

Figure 42. Chart of oceanographic observations of the seas adjacent to Japan—II

bottom topography and geology, heat flow on the bottom, gravimetry and geomagnetism.

Various new pieces of equipment for oceanographic observation are now being developed, for example, a ship-borne wave recorder, an air-borne radio-thermometer, a high-precision salinometer and an automatic observation device which records oceanographic phenomena in heavy weather and transmits the data to a land station.

Submarine topography, geology and sedimentology

With the object of exploring for oil, the sea bottom was investigated off the north-western coasts of Honsyu in 1958 and 1959. The investigation included soundings and dredgings, as well as gravimetric measurements to prepare charts of bottom topography and sediments, at a 1:50,000 scale. During this investigation, a flat surface, composed of coarse grain sediments, was found at a depth of about forty metres.

In conformity with the reclamation project of Simabara Kaiwan Gulf, on the west coast of Kyusyu, soundings and bottom dredging at about 1,000 spots were carried out in 1958, to prepare charts of bottom topography and geology. In 1959, supersonic exploration was carried out under the bottom surface with the Sparker. It was found that channels, excavated by strong currents, and neighbouring natural levees were disposed along the direction of tidal currents. Several shelf channels which may have been formed by glaciation were discovered. (See figure 43.)

As part of construction projects for railway bridges and submarine tunnels connecting Honsyu with Hokkaido at Tugaru Kaikyo Strait, and Honsyu with Sikoku at Akasi Seto Strait, precise investigations of bottom topography and geology were made. In 1958, a boring survey was carried out at a few dozen spots. Cores of bed-rock less than two metres in length were picked up from the sea bottom. The Sparker explorations were made at Akasi Seto and Naruto Kaikyo between Honsyu and Sikoku in 1959, and confirmed the geological structure inferred before through surveying and dredging in 1957 and 1958, which disclosed the structures of faults and anticlines. It was found that synclinal structure formed cuesta topography in Tugaru Kaikyo.

In connexion with the highway construction projects between Honsyu and Sikoku, Sparker soundings and dredgings were made along the planned routes from 1959 to 1961 in order to prepare bottom sediment charts at a 1:10,000 scale. On this survey, an extension of the stratum was found which may be attributed to an early diluvial epoch.

As part of the submarine cable construction project between Japan and Guam Island, Ensyu Nada, off the

southern coast of Honsyu, was investigated in 1960 with the Decca navigator system to prepare charts of submarine topography and geology at a 1:200,000 scale. The detailed structure of the large submarine valley became clear; the bottom of the valley was revealed as very flat all over. In May 1961, topographical and geological surveys and temperature measurements of bottom water were made on the Takuyo along several routes connecting Honsyu with Guam as preparation for bathymetric and submarine topographic charts. As a result of this investigation, it was discovered that extensive flat bed areas exist at 1,000 to 3,000 metres in depth to the east of Izu Syoto, and are crossed by several submarine valleys which flow into the Japan Trench. It was also found that the topography of Ogasawara Trough was completely flat for 420 nautical miles, while the Mariana Trough was a very undulate basin. About twenty uncharted seamounds were discovered, including three with elevations greater than 3,000 metres.

In order to secure fairways, emergency surveys were carried out immediately after the Isewan Taihu (typhoon Vera) in September 1959 and the tsunami which resulted from the earthquake that took place off Chile in May 1960. It was found that the paths of tidal waves due to typhoons were greatly affected by the bottom topography, and consequently that those parts of a dike which lay on vestiges of waterways were more disastrously damaged than its other parts. Erosions due to the tsunami were found to be influenced by the bottom topography rather than by the height of waves.

During the investigations in the Japan Trench on the Takuyo in 1959, a seamound 2,600 metres in depth was discovered in the east side of the trench. Both sides of the trench are very steep from a depth of about 7,000 metres, though the bed is very flat. Samples of a diatom ooze layer thirty centimetres in thickness were obtained from the bottom, 8,065 metres in depth. The southern part of the trench was filled with sediments of rich organic substances. A peculiar circumstance preventing water flow seems to exist on the bottom.

In April 1961, the sampling method used on the deep sea bottom was tested in Suruga Wan Bay on the southern coast of Honsyu. A core sample 3.5 metres in thickness was taken from the bottom at a depth of 3,000 metres.

In the oceanographic observation from May to June 1959, in the south-eastern part of Kyusyu, a guyot was discovered at a depth of 3,787 metres. The guyot has a conspicuous shelf on its edge and a moat 250 metres deep and from twelve to twenty-two kilometres wide at its foot.

The number of shoals and seamounds heretofore discovered in the seas adjacent to Japan has exceeded 500; some of them are listed in table 1. (See also figures 43 and 44).

Table 1. Preliminary list of main seamounds and shoals discovered in the seas adjacent to Japan

No. ^a	Latitude	Longitude	Depth	Surrounding depth (metres)	Date of survey	Vessel ^b	Remarks ^c
1	44°51' 2N	146°23' 7E	336	1,500	8 May 1942	Toyama-maru	
2	44 24. 7	139 29. 8	262	1,000	8 September 1952	Kaiyo-maru No 4	
3	44 24. 5	139 31. 6	238	1,000	2 August 1949	Oshoro-maru	Shoal examination
4	43 58. 8	140 3. 7	194	700	8 September 1952	Kaiyo-maru No. 4	Shoal examination
5	43 49. 4	139 39. 0	853	1,700	13 September 1952	Kaiyo-maru No. 4	
6	38 30. 2	137 7. 4	239	800	10 August 1957	Tenkai	Hakusan-Se (shoal)
7	38 27. 2	137 21. 6	252	800	4 August 1957	Tenkai	Hakusan-Se (shoal)

Table 1 (continued)

No. ^a	Latitude	Longitude	Depth	Surrounding depth (metres)	Date of survey	Vessel ^b	Remarks ^c
8	40° 2' 4N	135° 19' 2	616	1,200	7 August 1943	Toyama-maru	
9	38 51. 5	136 1. 5	797	2,300	7 August 1943	Toyama-maru	
10	38 23. 9	133 32. 5	724	1,200	18 September 1956	Kaiyo-maru No. 4	
11	38 3 2	134 11. 1	397	700	25 September 1956	Kaiyo-maru No. 4	
12	36 47 7	135 29 4	646	1,200	14 June 1953	Kaiyo-maru No. 4	
13	36 4 8	143 28 0	2,662	5,500	22 September 1959	Takuyo	Kasima-Kaizan (seamount) No. 2. Discovered by the Takuyo in 1959 to be 2,889 metres in depth
14	35 47. 4	142 39. 3	3,614	6,000	9 August 1957	Meiyo	Kasima-Kaizan (seamount) No. 1. Discovered by the Komahasi in 1934 to be 3,937 metres in depth
15	33 19. 5	139 15 5	204	1,200	7 August 1960	Takuyo	
16	31 20. 2	138 44. 9	1,313	2,300	12 May 1941	Soya	
17	31 13. 9	139 13. 9	653	1,200	18 March 1941	Komahasi	
18	31 9 7	132 19. 0	1,512	2,000	5 August 1961	Takuyo	Hyuga-Kaizan (seamount). Discovered by the Komahasi in 1939 to be 1,774 metres in depth
19	31 0 4	138 58. 7	192	1,000	24 October 1936	Komahasi	Shoal examination
20	33 57. 4	137 21. 6	776	1,200	11 March 1939	Komahasi	
21	29 53 8	133 19 3	289	1,600	25 March 1939	Komahasi	Shoal examination
22	28 5 2	134 39. 8	500	2,200	5 August 1960	Komahasi	Komahasi-Kaizan (seamount). Discovered by the Komahasi in 1940 to be 440 metres in depth (charted). See figure 43
23	26 45. 6	135 22. 5	270	1,500	18 April 1938	Kosyu	Shoal examination
24	25 52. 5	136 4 5	1,336	2,000	6 March 1935	Komahasi	
25	29 54 7	128 52. 9	69	280	27 May 1951	Kaiyo-maru No. 4	
26	28 57 2	128 48 9	649	800	28 June 1941	Kaiyo-maru No. 1	
27	27 55 1	127 58 0	472	900	13 February 1940	Komahasi	
28	25 35 3	125 4 6	960	1,600	3 November 1939	Komahasi	
29	22 25 7	121 13 8	417	1,000	28 February 1940	Komahasi	
30	22 19 8	121 13 0	715	1,000	28 February 1940	Komahasi	

^a Each seamount or shoal in figure 44 is identified by the number in this column.

^b All of the vessels belong to the Hydrographic Office except the Oshoro-maru (No. 3), which belongs to Hokkaido University.

^c Names of shoals and seamounts in this column are temporary ones.

SURVEYS

Ordinary surveys

In order to keep the nautical charts up to date, the surveys listed in table 2 have been carried out around the coast of Japan.

Table 2

Type of survey	Scale	Number of operations				Total
		1958	1959	1960	1961 ^a	
Harbour survey, first-order	1:3,000-1:10,000	4	6	2	7	19
Harbour survey, second-order	1:3,000-1:10,000	2	1	4	7	14
Coastal survey	1:15,000-1:50,000	8	7	5	5	25
Oceanic survey	1:1,000,000-1:500,000	6	6	17	15	44
TOTAL						102

^a Including surveys to be carried out.

Total of surveys hitherto completed:

	Number of sheets
Harbour survey	315
Coastal survey	100
Oceanic survey	13

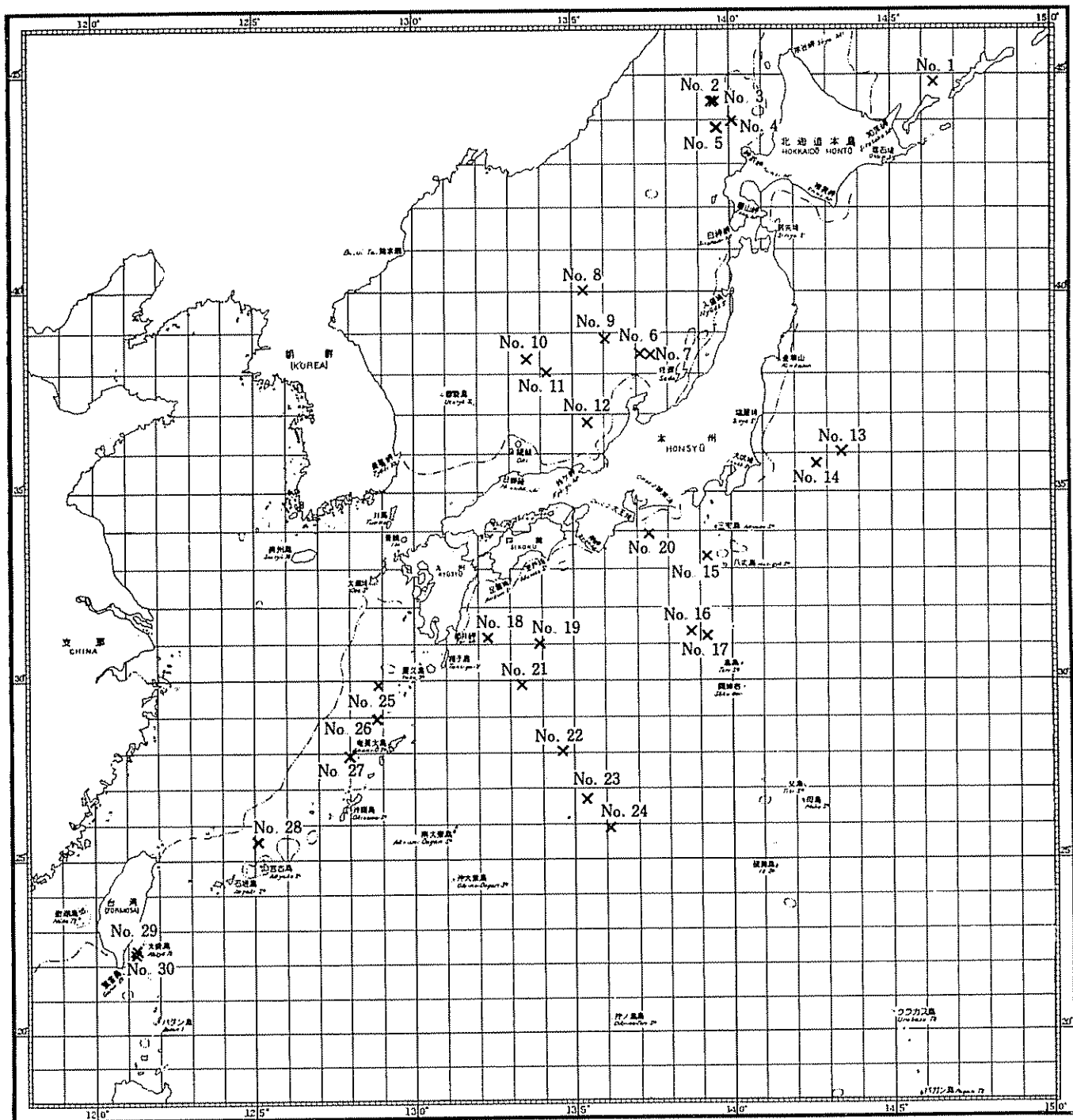

Figure 44. Main seamounts and shoals discovered in the seas adjacent to Japan
 Note: The numbers on the map correspond to those in the first column of table 1, page 130.

Topical surveys

Table 3

Year	Type of survey	Scale	District	Object
1958	Gravimetric and bathymetric surveys	1:50,000	North-western coasts of Honsyu	Oilfield excavation
	Submarine topographical and geological surveys	1:15,000	North-western coasts of Honsyu	Oilfield excavation
	Dredgings	1:20,000	Honsyu-Hokkaido, Honsyu-Sikoku	Railway construction
	Bathymetric, submarine topographical and geological surveys	1:10,000	Western coast of Kyusyu	Reclamation
1959	Gravimetric and bathymetric surveys	1:50,000	North-western coasts of Honsyu	Oilfield excavation
	Sparker surveys	1:10,000 1:5,000 1:20,000	Honsyu-Sikoku	Highway construction
			Western coast of Kyusyu	Reclamation
1960	Submarine topographical and geological surveys	1:200,000	Southern coast of Honsyu	Submarine cable construction
	Submarine topographical and geological surveys	1:10,000	Honsyu-Sikoku	Highway construction
1961	Submarine topographical and geological surveys	1:500,000	Tokyo-Guam	Submarine cable construction
	Submarine topographical and geological surveys	1:10,000	Honsyu-Sikoku	Highway construction

Equipment

A Decca navigator system is mainly employed for the surveys off Hokkaido. A portable echo sounder for shallow water, designed in 1957, is under improvement so as to meet the following practical requirements: accuracy, ± 5 cm \pm (0.02 depth); range, 0-18 m, 15-33 m; power, 100 w/h and weight, 20 kg.

For precise investigation of bottom topography during the International Indian Ocean Expedition, an echo sounder for deep sea is under construction, the accuracy of which is expected to be better than 1:5,000. A stylus is driven with a high-precision quartz crystal that can be calibrated through a standard frequency. Two recorders, whose full scales are 2,000 and 200 metres, respectively, are driven synchronously.

The Takuyo and another survey ship are equipped with piston core samplers for deep sea sediments. The length of the instrument is 7 metres, it is 80 millimetres in diameter and weights about 350 kilogrammes. The touching of the sea bottom by the ballbreaker is detected on board the ships by hydrophone.

The Basic Marine Map

Japan, being a seagirt country, is very interested in various activities concerning the sea, including public works, resources exploitation and transportation. Hence, the Hydrographic Office is preparing plans for the "Basic Marine Map". This map is intended to provide basic information for every branch of marine activity—oceanographic research, preparation of a topographic chart at a 1:50,000 scale that may be utilized for disaster prevention projects and for sounding navigation with civilian atomic submarines, preparation of ordinary nautical charts at a 1:200,000 scale.

The survey is scheduled to be carried out in ten years; it will cover the sea within 100 miles of the coasts of Japan, and the Decca navigator system will be used. The interval of sounding lines is 0.3-1 mile, and the draft

sheet will be prepared at a 1:50,000 scale. The accuracy of sounding is 0.1-10 metres and that of position fixing is better than 50 metres.

DRAFTINGS AND REPRODUCTIONS

Number of publications

Table 4

Charts	1958	1959	1960	1961 (to be published)
<i>New charts</i>				
Nautical charts	8	8	5	13
Special charts	6	1	6	4
Aeronautical charts	0	0	0	2
<i>New editions</i>				
Nautical charts	27	26	18	21
Special charts	8	11	7	2
Aeronautical charts	0	1	0	2
Reprints	28	33	35	29
TOTAL	77	80	71	73

The number of paragraphs appearing in the *Notices to Mariners* for corrections to published charts and publications are as follows:

Year ^a	Number
1958	1,557
1959	1,620
1960	1,943
1961	1,205

^a As of 30 September of year stated.

Total number of charts available on 30 September 1961

Nautical charts	1,476	{ Coast of Japan (inclusive of 5 Loran charts)	376
		{ Foreign coasts	1,100
Special charts	209	{ Bathymetric charts	18
		{ Submarine geological charts	10
		{ Fishery charts	17
		{ Magnetic charts	6
		{ Other	158
Aeronautical charts	13	{ WAC	9
		{ Other	4
TOTAL			1,698

The programme to cover the whole coast of Japan by thirty-six charts at 1:200,000-1:250,000 scale is in progress. (See figure 45.) Loran charts have been compiled and published since 1960. In co-operation with the Tokyo University of Mercantile Marine, a radar chart at 1:100,000 scale was tentatively prepared. The series of antarctic charts has been prepared and revised, S13 being the latest.

Development and research

Each chart is kept under continuous revision, not only to make navigation easier and safer, but to eliminate any unnecessary descriptions.

Now that aerial photographs are used for hydrographic charting, a contour line system instead of a form line system has been adopted since 1959 to express land topography.

Since 1958, the stick method has been employed extensively to draft charts. At present, the scribing system is adopted for about a quarter of the drafting work. Some charts are compiled on a Mylar base. By this method, drafting can be done directly from the raw materials, and figures and symbols can be put on accurately and easily.

Since 1959, photographic film has been used as the original copy instead of zinc plate.

In 1960, the "Neo-Vandyke Process" was developed for extensive use in photomechanical processing. Utilizing polyvinyl alcohol for sensitizer, the contact print from a positive copy of a draft is lightly etched with a lactic acid liquid. The engraved film for reproduction is obtained by reversing the etched copy. This process can be applied widely, e.g., for film positive and paper positive, and lines can be reproduced very clearly without need for skilled specialists.

For publications which contain many Roman letters, various symbols or tables of figures, reproduction is now done with photocomposing; the letter or symbol is laid out directly in its original size, then a copy for reproduction is made photomechanically without a camera through the Neo-Vandyke Process.

Electrophotography is now under investigation for application to chart reproduction.

The specifications of the chart paper were amended in April 1961. The durability of the paper against various physical processes is excellent. (See annex II.)

ANNEX I

Table I. Survey Vessels

Vessel	Tonnage (gross tons)	Engine (ps)	Speed (knots)	Range (metres)	Construction
Takuyo	771	(Diesel) 650 × 2	12	7,600	1957
Meiyo	355	(Recipro.) 1,400 × 1	10	2,700	1943
Kaiyo	203	(Diesel) 400 × 1	10	1,500	1942
Tenyo	121	(Diesel) 230 × 1	10	3,160	1961
Heiyo	51	(Diesel) 150 × 1	9	670	1955

Surveying boats 21 (109 g. t.)
Total, 26 vessels (1,610 g. t.)

Table II. Main equipment of survey vessels

Vessel	Surveying instruments	Oceanographic observation instruments
Takuyo	Precise echo sounder for extreme deep sea	Wire and winch (8,000 m, 15 h.p., for serial water sampling)
	Precise echo sounder for deep sea	— do — (3,000 m, 5 h.p., for serial water sampling)
	Loran, 2	— do. — (1,500 m, 3 h.p., for serial water sampling and B. T.)
	Piston core sampler	Self-recording thermometer
	Tapered wire (12,000 m) and winch (120 h.p.)	G. E. K.
	Decca navigator system ^a	B. T.
	Dredger ^a	Water bottles
Snapping sampler ^a	Protected reversing thermometers	
	Unprotected reversing thermometers	
	Photoelectric colorimeter	
	Scintillation counter	

Table II. (continued)

<i>Vessel</i>	<i>Surveying instruments</i>	<i>Oceanographic observation instruments</i>
Meiyo	Precise echo sounder for extreme deep sea Precise echo sounder for shallow water Loran	Wire and winch (3,000 m, 5 h.p., for serial water sampling) — do. — (1,500 m, 3 h.p., for B. T.) G. E. K. B. T. Water bottles Protected reversing thermometers Unprotected reversing thermometers
Kaiyo	Precise echo sounder for deep sea Precise echo sounder for shallow water Loran	Wire and winch (3,000 m, 5 h.p., for serial water sampling) — do. — (1,500 m, 3 h.p., for B. T.) G. E. K. B. T. Water bottles Protected reversing thermometers Unprotected reversing thermometers
Tenyo	Precise echo sounder for deep sea Precise echo sounder for shallow water Loran	Wire and winch (3,000 m, 5 h.p., for serial water sampling) — do. — (1,000 m, 2 h.p., for B. T.) G. E. K. Water bottles Protected reversing thermometers Unprotected reversing thermometers
Heiyo	Precise echo sounder for deep sea Precise echo sounder for shallow water	Wire and winch (1,500 m, 3 h.p., for serial water sampling and B. T.) G. E. K. B. T. Water bottles Protected reversing thermometers Unprotected reversing thermometers

• Used on the other vessels occasionally.

ANNEX II

QUALITY SPECIFICATION OF CHART PAPER 135 KG

Amended on 1 April 1961

- Size should be 765 mm × 1,085 mm or 543 mm × 765 mm admitting error within ±1.5 mm. Each corner of the paper should be rectangular, the longer side being exactly parallel to the machine direction.
- Thickness should be 0.17 ± 0.01 mm.
- Average expansion should be within 0.20 per cent in both the machine direction and the cross direction against an increase in relative humidity of from 65 to 80 per cent.
- The paper should withstand folding at least 1,500 times in both directions.
- Tensile breaking strength should, on the average, be over 15.0 kg in the cross direction and over 7.5 kg in the machine direction.
- Smoothness of the felt side should be over 50 seconds, on the average.
- The average paper weight should be 163 ± 8 g/m².
- The paper should be fit to write on with pencil or ink; it should not become nappy through erasing with india rubber or knife, and it should never become blotted with ink after a test of rub endurance.

- Surface strength of paper should be larger than 18 in the Dennison wax number scale.
- Area of a dirty spot should be smaller than 0.2 mm² so as not to affect reproduction and use.

ASSOCIATE QUALITY SPECIFICATION OF CHART PAPER 135 KG

Amended on 1 April 1961

- The average bursting strength should be greater than 5.0 kg/cm².
- The average tearing strength should be over 180 g along both the machine direction and the cross direction, and it should be over 200 g in a wet state.
- pH value of paper should be larger than 4.5.
- Degree of sizing should be over 200 seconds, on the average.
- Brightness should be over 80 per cent, on the average.
- Spectral reflectivity should be approximately in accordance with the following table:
Wave-length mμ—400 420 440 460 480 500 520 540 560 580
600 620 660 700;
Reflectivity percentage—78 82 85 88 90 91 93 93 93 92 93 93 93 94.
- Opacity should be better than 93 per cent in dry air, on the average.
- The paper should retain 77 per cent of brightness through a four-hour exposure to the Atlas-type fadeometer.

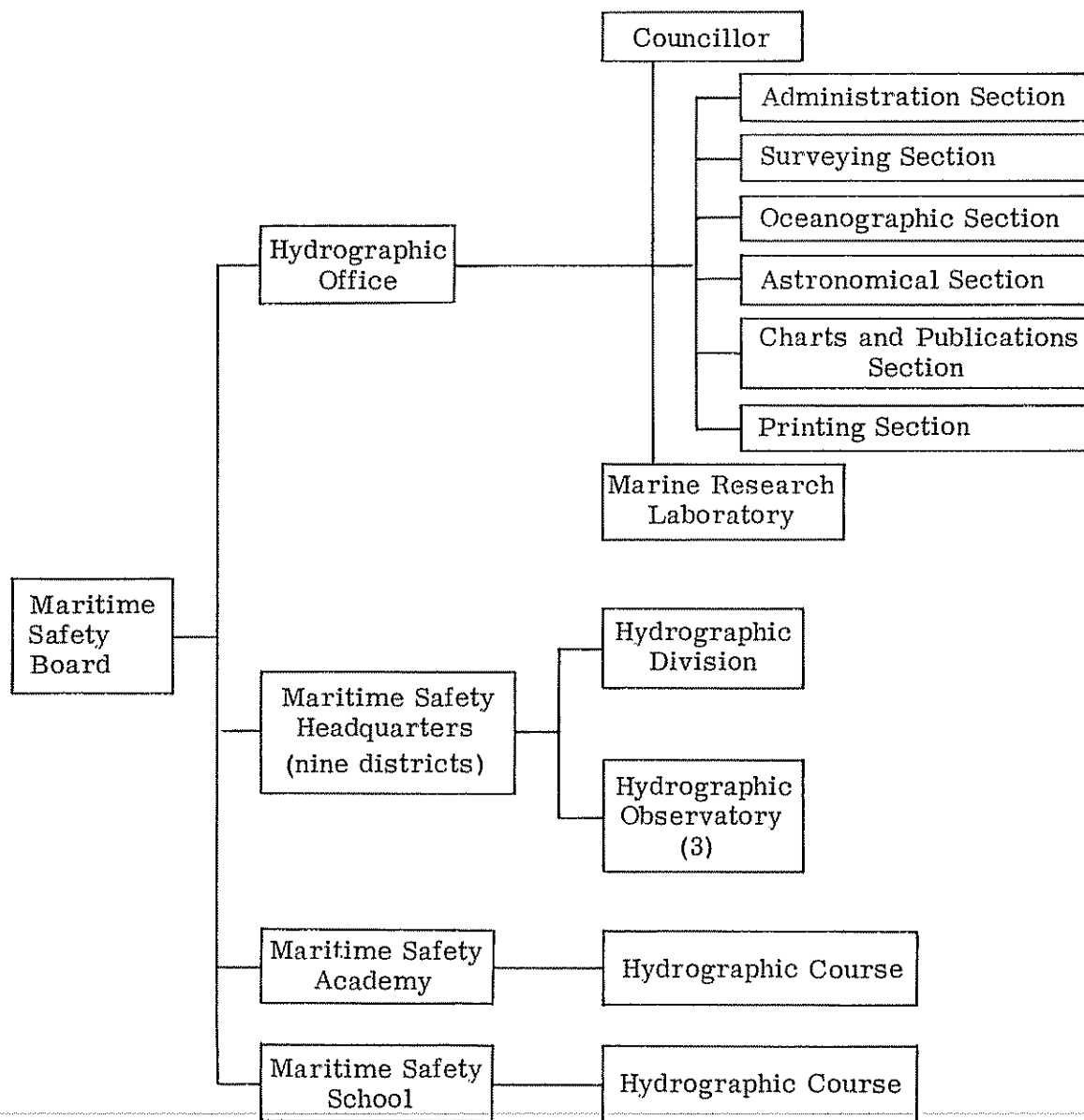

Figure 46. Diagram showing organization of the Maritime Safety Board and the Hydrographic Office of Japan

REPORT ON PROGRESS IN HYDROGRAPHIC SURVEYING IN THAILAND¹

TRIANGULATION COVERING THE BANGKOK AREA

To meet the needs of the proposed survey of the Chao Phraya River, on which Bangkok is located, and to have sufficient horizontal controls tied up, the minor triangulation covering the area was carried out in 1959.

The triangulation was based on three geodetic stations, namely, Phu Khao Thong, the weather station and the lighthouse, whose positions had been determined by tellurometer two months before.

Positions of ten prominent landmarks were obtained with third-order accuracy and those of several others were

obtained by intersections. For a diagram of this triangulation net, see figure 47.

RIVER SURVEYS

To meet the needs of the great number of people who use the waterway as an important means of transportation, and especially to meet the needs of seagoing vessels, a hydrographic survey of the Chao Phraya River and the Pak Panang River has been made.

HYDROGRAPHIC SURVEY OF THE CHAO PHRAYA RIVER

General statement

To provide the mariner with up-to-date charts of the Chao Phraya River, which is the most important waterway

¹ The original text of this paper, submitted by Thailand, appeared as document E/CONF.36/L.24.

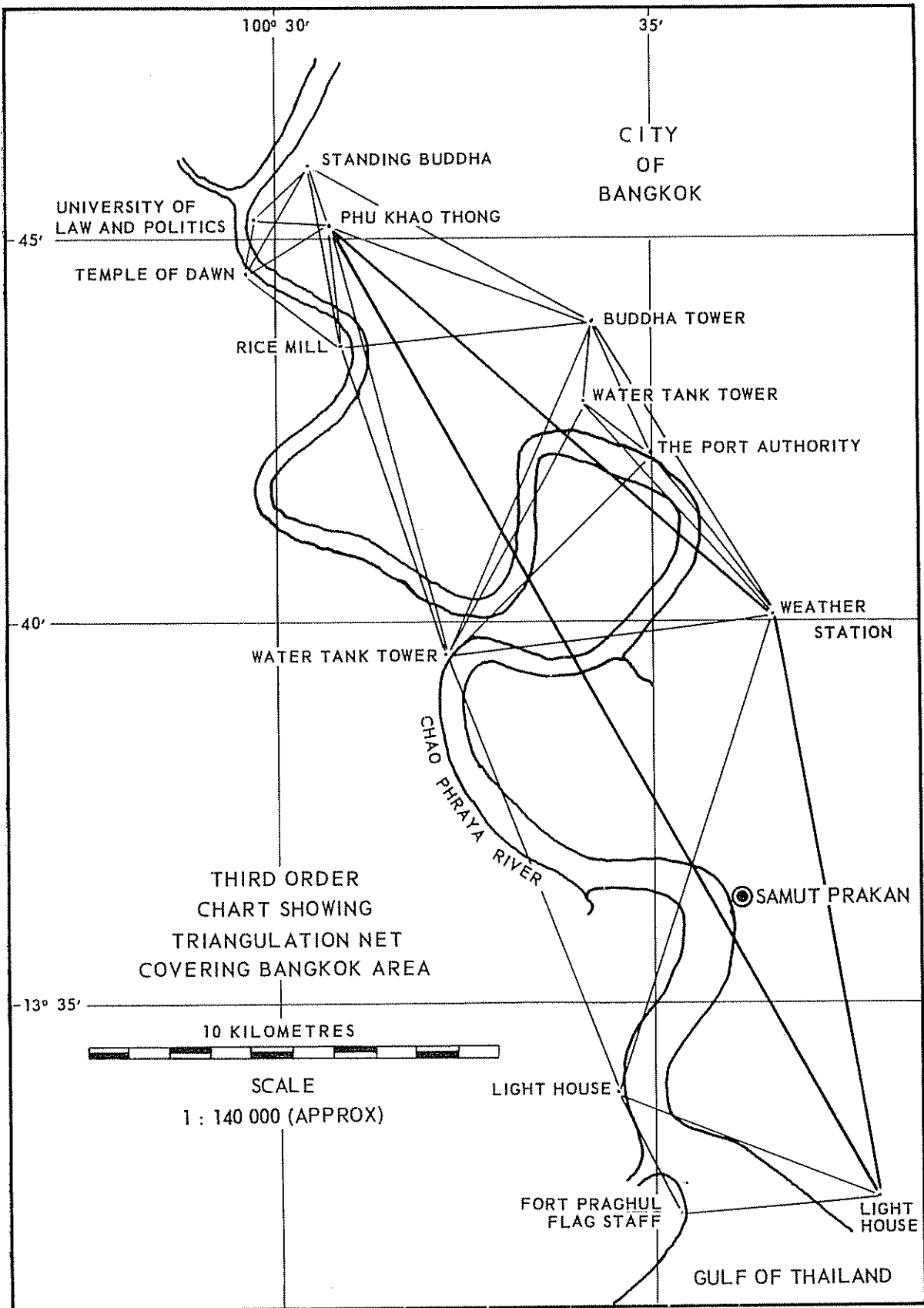

Figure 47. Third-order triangulation net covering the Bangkok area

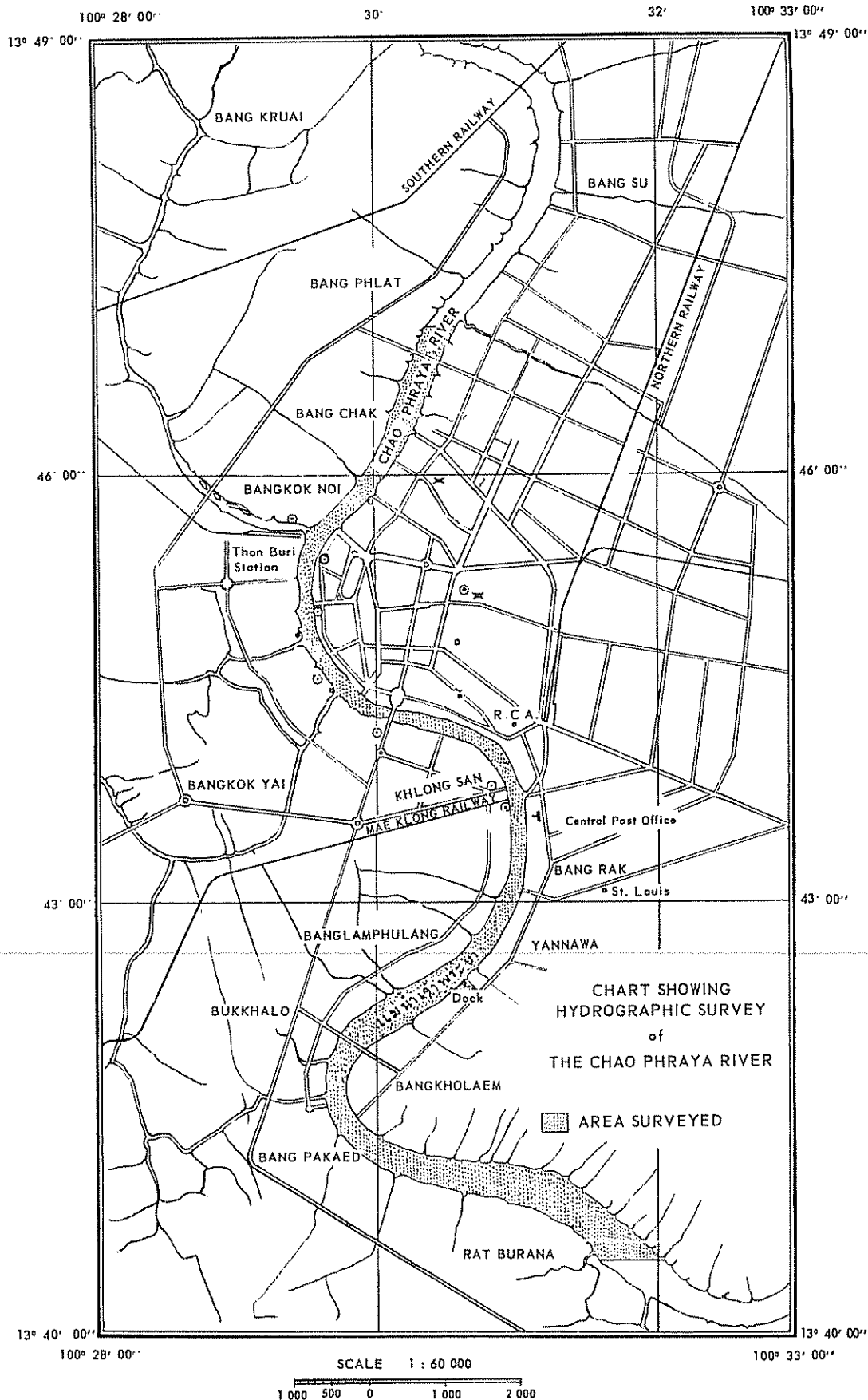

Figure 48. Chao Phraya River, Thailand: Chart of hydrographic survey

in Thailand since large vessels can navigate from its mouth to Bangkok, a survey was made in 1929 from the sea in the south to Bangkok.

Several surveys have been made from the Bangkok Bar, twenty-seven kilometres from the mouth of the river, to the harbour site by the Port Authority. Other parts of this area were left to be surveyed by the Hydrographic Department.

Area surveyed

Figure 48 shows the area surveyed by the Hydrographic Department along the river, which as an average width of 300 metres and is seventeen kilometres long.

Scale

The scale of survey was 1:5,000.

Horizontal control

Horizontal controls along the river banks were based either on signals or on man-made objects, whose positions were mostly determined by intersection resection, connected to prominent landmarks, the positions of which had already been determined by third-order triangulation.

Sounding datum

All soundings were taken by an echo sounding machine, and then reduced to the river's lowest low-water level, obtained over twenty-three years of observation.

HYDROGRAPHIC SURVEY OF THE PAK PANANG RIVER

General statement

The Pak Panang River is another important river on the west coast of the gulf in southern Thailand; it is named after the district of Pak Panang through which it flows. A vessel with a maximum draught of 2.5 metres can pass through the bar into the river at high tide.

Area surveyed

The hydrographic survey was initiated from the mouth of the river on the north, up the river southward to the district. The average width of the river in the surveyed area is 200 metres, the total over-all length nine kilometres.

Scale

The scale of survey was 1:5,000.

Horizontal control

Horizontal controls along the river were signals, the positions of which were obtained by fourth-order triangulation, extended from two third-order traverse stations. All angles of the triangles were observed with a sextant.

Sounding datum

All soundings were reduced to the lowest low-water level of the river.

HYDROGRAPHIC SURVEY OF KO SICHANG HARBOUR

Geographical aspects

Ko Sichang Harbour consists of the main island of Sichang and eight smaller islands on the north, east and south. It is the group of islands closest to Bangkok, only eighteen nautical miles from the Bangkok Bar. In certain areas the depth is forty metres. The harbour is used by large vessels of considerable draught which are unable to pass through the bar at the mouth of the Chao Phraya River.

Location

The harbour is situated on the extreme north of the Gulf of Thailand, twenty nautical miles from the north coast and seven from the east coast.

Survey limit

Latitude 13° 05' 45" N to latitude 13° 12' 00" N;
Longitude 100° 46' 30" E to longitude 100° 51' 30" E.

Scale

The scale of the survey was 1:10,000.

Area surveyed

Ninety-seven square kilometres of water area were surveyed.

Chart datum

Lowest low-water level during a fifteen-year period.

Horizontal control

Third-order triangulation net covering the area surveyed.

COASTAL AND OFFSHORE SURVEYS

In 1960, the Hydrographic Department carried out surveys in Thai waters, extending to international areas, in three different zones, namely:

1. A coastal survey along the coast of Songkhla Province;
2. An offshore survey on the east coast of Nakhon Sithammarat Province
3. A survey of Ko Sichang Harbour.

An area of 1,510 square kilometres was covered by the surveys. The surveys included the measurement of depths, the determination of geographical positions of such depths, the location of wrecks, aids or obstructions to navigation and other hydrographic features.

THE COAST OF SONGKHLA PROVINCE

Location

The survey area is located immediately north of the town of Songkhla, the most important commercial town in the southern part of Thailand.

Survey limit

Latitude 7° 16' 00" N to latitude 7° 39' 00" N;
Longitude 100° 22' 00" E to longitude 100° 37' 00" E.

Scale

The scale of the survey was 1:20,000.

Area surveyed

Seven hundred and nine square kilometres of water area were surveyed.

Chart datum

Lowest low-water level.

Horizontal control

In the water close to shore, the control was based on coastal signals of positions determined by third-order traverse. In the area two nautical miles beyond the shore, where signals were out of sight, buoys were used whose positions were determined by low-order triangulation.

CUT OF NAKHON SITHAMMARAT PROVINCE

Location

The survey area is located four nautical miles off the coast of Nakhon Sithammarat Province in the southern part of Thailand.

Survey limit

Latitude 8° 50' 00" N to latitude 9° 03' 00" N;
Longitude 100° 00' 00" E to longitude 100° 16' 00" E.

Scale

The scale of the survey was 1:20,000.

Area surveyed

Seven hundred and three square kilometres of water area were surveyed.

Chart datum

Lowest low-water level.

Horizontal control

The control in the area was based on buoys, whose positions were determined by triangulation extended from third-order traverse stations on the coast. All angles of the triangles in the net were observed with a sextant.

HI-FIX¹

Background paper by the United States Navy Hydrographic Office

For the past several years, the United States Navy Hydrographic Office has sought an easily portable electronic navigation system which incorporated such other features as lane identification, maximum range and flexibility of operation. Currently, Hi-Fix is under test and evaluation. This system seems to offer most of the desired features in that it can be operated either as a

hyperbolic or a ranging system, is lightweight, highly mobile and ruggedly constructed, and in that lane identification can be furnished, if desired. Its other advantages make it possible to fit the system to a wide range of survey situations. Hi-Fix can be operated as a high-power or low-power system, the desired range being the major controlling factor effecting the choice. A large selection of display equipment is available; some examples being track plotters, fix printers, punched tape readout, frequency indicators and independent displays which show the distances from the slave stations in feet or metres.

¹ The original text of this paper and those of the following seven papers were submitted by the United States of America and appeared together as document E/CONF 36/L.40.

D. M. RAYDIST

Background paper by the United States Coast and Geodetic Survey

The D.M. Raydist is a two-range survey system manufactured by Hastings-Raydist Company of Hampton, Virginia. In this system, the distances in lane widths from the ship to each of the two shore stations are given directly on dials on board the ship. Two-range systems, such as the D.M. Raydist, have many advantages over other survey systems, such as Decca, whose the lines of position are hyperbolic in shape. Some of the advantages are that the lane widths do not change with distance from the shore stations, distance circles are easier to construct than hyperbolic curves on a survey sheet, and only two instead of three shore stations are required.

A D.M. system consists of two shore stations, designated as RED and GREEN, and a shipboard installation. This system requires the use of four radio frequencies, which are normally in the frequency band between 1,600 and 4,000 kilocycles. Two of these frequencies have to be harmonically related, that is, one must be exactly twice the other in frequency. These two frequencies are used to determine the lane widths and distance from the shore stations to the ship. The other two frequencies relay additional information obtained at the shore stations back to the ship.

The equipment aboard ship consists of a dual-frequency receiver (for the two harmonically related frequencies), two relay-frequency receivers, a continuous-wave transmitter, and an indicator showing the position of the ship to a fractional part of a lane. At the RED shore station, there is the same dual-frequency receiver as on board ship and a continuous-wave transmitter which relays the addi-

tional information back to the ship. The GREEN shore station also has the dual-frequency receiver, but only the modulated relay-frequency transmitter. By the use of filters, the various receivers and transmitters at each of the two shore stations and on the ship operate from a single antenna.

The operating distance will depend upon the season, time of day and area of operation. During periods of low noise level and no sky waves, distances as great as two hundred nautical miles have been achieved. For normal daytime operation, maximum range may be over one hundred nautical miles. Night-time operation is often restricted by sky waves and high noise levels. Ranges then may be restricted to less than fifty miles, and quite often there is a partial or complete shutdown of the system.

In many areas, the absolute accuracy of a position is not known, due to the uncertainty of the propagation or velocity of the radio waves. The change in velocity causes a change in the lane widths, thus introducing an error into the system. However, the repeatability of a position is quite good. It is possible to return to a fixed marker many times, with a variation of 0.2 to 0.3 lane in the total value. If the two harmonically related frequencies are 1,650 and 3,300 kilocycles, then a lane width is approximately forty-five metres. Thus, the repeatability is within nine to fourteen metres. To realize the best accuracy and maximum range from the system, all signal paths should be over water, including the signal path between the two shore stations.

Some of the desirable features of the D.M. Raydist system are that it is easily transported, erected and operated by relatively unskilled personnel. There is no manual operation, and the system is self-tracking. All the electronic circuits are conventional and can be serviced by the average technician. The range and accuracy are satisfactory for coastal surveys.

The undesirable features are that there may be lanes lost due to noise, sky waves or system failures. When this happens, the ship must return to a calibrating point and reset the lane count dials. Consequently, the system must be recalibrated and reset each time it is used after interruptions of any kind. Technical assistance is usually required

for the initial installation and adjustment of the system. This system is an active one in that there is a transmitter on board the ship. Thus, only two ships can use a pair of shore stations at one time, and only under certain conditions.

The Coast and Geodetic Survey first started using D.M. Raydist in 1957 and, at the present time, has three systems operating. In co-operation with the manufacturer, many improvements have been made. These improvements include the reduction of antennas at the shore stations as well as on board ship, making the adjustment of the system less critical and the development of calibrating and operating techniques.

ECHO SOUNDING INSTRUMENTS

Background paper by the United States Coast and Geodetic Survey

This discussion includes only the general-purpose survey instruments now being manufactured in the United States. It excludes the special-purpose instruments used for horizontal projection and bottom penetration studies, as well as those used for special military purposes. The list includes only commercial instruments at present available on a production basis.

For classification purposes, the survey echo sounders have been divided into two classes—shallow-water and deep-water instruments. Special recorders, power supplies and transducers sufficiently important to be given consideration are included in this discussion.

Shallow-water echo sounders

For the purpose of definition, a shallow-water instrument can be defined as having sounding capabilities of 250 fathoms or less—an arbitrary selection. All the instruments to be described are characterized by low power requirements and have various ranges of portability.

255C

Manufactured by EDO Corporation, College Point, New York. This is a linear recorder intended to sound in depths to 230 fathoms. While this instrument will sound in feet, it requires a gear change to produce the stylus speed change.

This instrument is used in sounding launches and as the shoal water instrument on survey vessels. There are less than a dozen 255C instruments in use in the Coast and Geodetic Survey, and these are being replaced. The EDO Company is replacing this instrument with a newer one designated as the 555, similar to the 255C but with an improved recording system and amplifier.

The characteristics of the 255C are as follows:

Operated on an acoustic frequency of 37.5 kilocycles, using a barium titanate transducer;
Sounds in feet or fathoms;
Transducer driven by a vacuum tube oscillator;
Sounding range: 0-65, 55-120, 110-175, and 165-230 feet or fathoms;
Cabinet sizes: $18\frac{1}{2} \times 13 \times 9\frac{1}{2}$ inches;
Weight: 63 pounds;
Power required: 115 volts, 60 cycles, 120 watts;
Approximate cost: \$3,000.00.

Since this instrument uses a synchronous motor to drive the stylus belts, a precision power supply must be provided as auxiliary equipment.

DE-723

This is the newest of all portable shoal water echo sounders, manufactured by the Raytheon Company of Waltham, Massachusetts. The main features of this instrument are its ruggedness and trouble-free operation. It is designed to require a minimum of maintenance and can be adjusted by field personnel.

This instrument is a return to circular recording after years of attempts by the United States and other countries to make a simple field-use shoal water sounder. The dependability of the circular recording system offsets its disadvantages.

The DE-723 is divided into two packages, the recorder package and the electronic package. There are no active electronic elements in the recorder package, just the motors, switches, controls and recording stylus. The elements in the electronic package are easily replaceable as they are plug-in units. Another outstanding feature of this instrument is the large amount of power to the transducer and the sensitivity of the receiving system. The DE-723 has received echoes in well over 500 fathoms.

The characteristics of the DE-723 are as follows:

Sounds on acoustic frequency of 21 kilocycles;
Sounds in feet or fathoms—can be changed by a front panel switch;
Sounding scales: 0-50, 40-90, 80-130, 120-170, 160-210 and 200-250 feet or fathoms;
Magnetic keying, which eliminates mechanical keying contacts, phasing errors and contacts replacements;
Cabinet sizes: recorder, $18\frac{3}{4} \times 15 \times 8\frac{9}{16}$ inches; electronic package, $18\frac{3}{4} \times 18\frac{3}{4} \times 7\frac{3}{4}$ inches;
The stylus and paper are driven by synchronous motors that require special precision power supplies.

Because of the plug-in features, it is possible to sound at 200 kilocycles by changing the transducer and the elements in the electronic package. This would be used where precise bottom delineation is needed.

TELEMETERED TIDE INFORMATION

Background paper by the United States Coast and Geodetic Survey

A telemetered tide station is now being used by the Coast and Geodetic Survey to transmit tide information directly to the survey ship. This is a part of the programme of supplying the survey ship with all the necessary information while the survey is under way.

The gauge of the tide station is of the pressure type (bubbler type). In addition to transmitting tidal information, recordings are also made at the station. The bubbler tide gauge lends itself to tidal measurements on the open coast, such measurements being difficult to make with regular well-type gauges.

The tidal information is transmitted for a few minutes every fifteen minutes. This is done to minimize interference and to conserve power. It also makes it possible to time the tidal information from the reception point,

and to permit insertion of tidal information from a second tide station between the fifteen-minute intervals. This has already been done in a case where tidal information was desired on two opposite sides of an island.

The transmitter used in the case mentioned above had a power output of one hundred watts on a frequency near 2,100 kilocycles. Normal day and night operational range of one hundred miles is reasonable. Over two hundred miles have been recorded with this transmitter.

This same telemetered system has been used with the bubbler gauge and transmitter on a platform at sea, the recording equipment being on land. This was for the purpose of having a gauge in deep water as the tides were distorted in the shoal water areas.

PRECISION DEPTH RECORDER, MARK V

Background paper by the United States Navy Hydrographic Office

INTRODUCTION

The Precision Depth Recorder, Mark V, is a depth-recording instrument originally conceived and developed by members of the staff of the Lamont Geological Observatory of Columbia University. The instruments is usually referred to as the "PDR" and the Mark V has been manufactured for the United States Navy by the Times Facsimile Corporation and the Westrex Corporation since 1956. The present price is approximately \$7,500 and the weight is 140 pounds. All survey ships of the United States Navy are equipped with this model PDR as are other Navy ships which are engaged in projects requiring recording of precise configuration of the ocean floor.

FUNCTION OF THE PDR

The PDR is used to supplant the recorder unit of conventional Sonar sounding equipment. It is intended to be coupled to the transducer and transmitter of the deep-water echo sounding gear which is standard equipment aboard most United States Navy ships. This equipment is designated Sonar Sounding Set, AN/UQN-1. The PDR performs the timing function to better than one part in 1,000,000, displays the timing information and records the sounding information.

DESCRIPTION OF EQUIPMENT

The PDR is contained in a metal cabinet approximately $2 \times 2 \times 1$ feet. The front of the cabinet contains the switches for operation of the instrument and a plexi-glass scale for rapid scaling of depths directly from the echogram.

OPERATION OF THE PDR

The PDR, an integral part of the sounding equipment, cannot be discussed without detailed reference to other parts of the Sonar Sounding Set. The PDR is easily installed, requiring only 120 volts AC for operation, and a connexion to the sounding set by a single shielded

cable. The PDR measures the time interval between the transmission of electrical energy from the transmitter of the sounding set to the transducer. The transducer converts the electrical energy into sound energy of identical frequency which is propagated through the sea water. This sound energy is reflected back to the transducer from the ocean floor and reconverted to electrical energy by the transducer. This, in turn, is supplied to the receiver and displayed as time difference information, on a continuous graph, by the PDR.

The PDR controls, or times, the outgoing signal in a precise and integrated manner. It records the outgoing signal (once each second under average operating conditions), the incoming signal or bottom return, a three-minute interval and fathom mark every twenty fathoms. This information is continually recorded on a teledeltos-type paper which is in a 350-foot roll, nineteen inches wide. The operator energizes the PDR and the sounding set, synchronizes the PDR with precise time standard (WWV time signal or equivalent), sets the PDR in "run" position and indicates on the paper the time at which operation was commenced.

ACCURACY OF RESULTS

The paper width (nineteen inches) records up to 400 fathoms and/or multiples of 400 fathoms. One fathom then equals approximately one millimetre, with an estimated accuracy of one part in 3,000 exclusive of uncertainties in the average vertical velocity of sound. The PDR will operate, and display, a detailed picture of the ocean floor at any depth. The only limitations are the power capabilities and the signal-to-noise ratio of the sounding set installation.

MAINTENANCE

The PDR has been in use for many years and under a variety of conditions. It has proved to be rugged in design and easily adjusted and repaired. In addition, it is

simple to operate. If the PDR is allowed to run continually after it has been set, the operator need only note changes in 400-fathom depth increments and annotate the echogram with the date and time at predetermined intervals. If power supplied to the sounding set remains constant, any error in depth is avoided and the exact depth of water between the transducer and the ocean floor is recorded every second. A 300-foot roll of paper will last for over seven days of twenty-four-hour operation.

APPLICATIONS

The PDR is intended for use in deep-water surveys, where high precision and fine detail of ocean floor relief are required. Further applications include the recording of other marine data, such as sub-bottom structure, deep-scattering layer and the location of various equipment (i.e., underwater television and cameras beneath the ship).

PRECISION GRAPHIC RECORDER

Background paper by the United States Navy Hydrographic Office

INTRODUCTION

The Precision Graphic Recorder (PGR) is a depth-recording instrument developed by the staff of Woods Hole Oceanographic Institution and manufactured at the Alden Research Center, Westboro, Massachusetts. The PGR has, in the past, been a custom-built instrument costing approximately \$15,000 and weighing about 700 pounds. However, with the use of solid-state manufacturing processes and an expanding market, the price had dropped considerably.

FUNCTION OF THE PGR

The PGR replaces the recorder unit of conventional Sonar sounding equipment, but utilizes the transducer and transmitting portions of the Sonar Sounding Set AN/UQN-1. The PGR actuates the transmitter introducing precisely time-measured pulses of energy to the transducer.

DESCRIPTION OF EQUIPMENT

The PGR has a signal amplifier, a scale line generator, an event marker, a predetermined interval marker, a multi-speed mechanical drive with precision power supply and six paper speeds. In place of the stylus, as found on most depth recorders, a helical wire wound on a drum is rotated under a thin, straight edge which in turn revolves slowly to equalize wear. The writing range, or helix speed, varies from 1,200 r.p.m. on the twenty-fathom scale to eight r.p.m. on the 3,000-fathom scale. The outgoing signal, or ping length, can be varied from about two milliseconds at the fastest rate to about 0.5 second at the slowest rate. The normal helix extends the full length of the recorder, but two, three or four helices may be installed with a separate amplifier for each. By this method, up to four different sets of data can be recorded simultaneously.

OPERATION IN THE PGR

The precision power supply utilizes a tuning-fork controlled oscillator feeding a power amplifier. This system provides a constant power supply, accurate to within one part in a million. Available depth scales are 20, 25, 40, 50, 100, 150, 200, 300, 400, 500, 800, 1,000, 1,500, 2,000, 3,000 and 4,000 fathoms, and 200, 400, 4,000 and 8,000 feet.

The recording paper is Alfax Type A, a ferrous-ion-deposit, damp chemical paper. It is more responsive to sub-threshold voltages than the type with a dry carbonized inner layer. The Alfax paper also displays a number of tonal shades in response to variations in sound intensity.

ACCURACY OF RESULTS

The following parameters contribute to the accuracy of the PGR.

1. The time measuring capacity is better than one in 1,000,000.
2. The helix arrangement allows for accurate tracing without danger of loss of synchronization.
3. The paper is unaffected by temperature or humidity changes, and displays tonal shades in response to current variations.
4. Programming allows the PGR to vary paper speed, scale lines, depth interval, gating and recording phase. This variety of modes makes possible more detailed examination of the ocean floor, eliminates background noise and allows the bottom trace to be separated from the outgoing signal.
5. Multi-channel recording allows data from several transducers at different scales to record simultaneously with electronic navigational data, etc.
6. With the nineteen-inch paper and the twenty-fathom scale, the depth can be read with an estimated accuracy of one part in 60,000, or about twenty times the accuracy of a recorder limited to a 400-fathom scale.

MAINTENANCE

The PGR has not been fully evaluated by the Hydrographic Office, particularly over long periods of time (continual operation), under varied conditions. Considering the variety of functions which it performs, preliminary results indicate that it is a fine instrument. No unusual difficulties are anticipated.

APPLICATIONS

The PGR is the most versatile recording device now available. As a survey instrument, its design is suitable for measuring the smallest increments of micro-bathymetry as well as the grossest of features. The Hydrographic Office has purchased some of these instruments for use in locating cameras and coring devices above the bottom and for measuring and recording sub-bottom structures. It is used with the towed thermistor chain to give continuous recording of temperatures and for recording various types of navigational data.

SOUND VELOCIMETER SYSTEM

Background paper by the United States Navy Hydrographic Office

The United States Navy Hydrographic Office has developed a sound velocity recording system for use on oceanographic surveys. This system provides rapid and accurate measurements of sound velocity, depth and temperature from the surface to 9,000 feet. It provides simultaneously a digital display of all three variables in any desired units, an X-Y plot of any two of these variables, a printed record of any two variables and a punched-paper tape recording of all three variables. The velocimeter used is the Bureau of Standards TR-2, the depth gauge a Bryon Jackson Vibrotron, and a thermistor for the temperature element.

The entire system (including cable, winch, recording equipment and underwater unit) was engineered with the underlying philosophy of presenting the data straightforwardly and precisely and maintaining a high degree of reliability. Undesirable factors, such as non-linearity and temperature instability, have been largely eliminated. No range changes are required to maintain accuracy and readability or to minimize non-linearity. Each parameter is displayed and printed in conventional units with no necessity for corrections or reference to calibration sheets. The punched-paper tape is prepared in binary-coded decimal form ready for direct entry into a computer for rapid data processing.

The accuracies that can be achieved with this system are: sound velocity, 0.3 m/sec; pressure, 0.25 per cent; temperature, 0.04° C.

Sound velocity

The Bureau of Standards TR-2 is the velocimeter used; the device has an advertised inherent accuracy of greater than 0.01 per cent; however, the method that must be used to calibrate the instrument requires that the meter be calibrated in a liquid for which the velocity of sound is accurately known. Since there is some disagreement as to the value for sound velocity in distilled water, amounting to some 0.3 m/sec over 0-30° C range, the system's accuracy can be no greater than this figure.

Depth

The depth gauge used is a Bryon Jackson Vibrotron. It is temperature-stabilized by a thermostatically controlled oven to eliminate temperature effects.

Temperature

The temperature sensor is a single thermistor. There are no electronics in the underwater unit associated with the temperature circuit.

The recording system has been engineered around commercial "off-the-shelf" components modified for the specific application. Basically, it consists of three electronic counters, a scanner, a tape punch, a digital recorder and an X-Y recorder.

SOUND VELOCITY STUDIES

Background paper by the United States Coast and Geodetic Survey

In those areas where the velocity of sound in sea water is uncertain and variable, the Coast and Geodetic Survey requires that this velocity be measured and, if necessary, a correction be applied to the echo sounding. The determination of this correction is generally made by sampling the temperature and salinity of the water at various depths and computing the velocity. In general, the sound velocity is processed and the correction applied later. A new technique is now being tested which will supply the sound velocity data immediately. This technique is made possible by means of the Velocimeter developed by the National Bureau of Standards.

The Velocimeter measures sound velocity directly and immediately. Consequently, it gives the hydrographer a profile of sound velocity from the surface to the bottom

as quickly as it can be lowered and recorded. Such a meter speeds up the velocity determination so that many observation stations can be made in a short time.

By the use of this meter, a sound velocity survey of the entire area can be made prior to the survey. This can be done in one day, and an area velocity picture acquired. By analysing this sound survey, it is possible to determine a correction which is applied to echo soundings on an area basis. Experience so far shows that areas not subjected to strong currents have a uniform sound velocity pattern. These areas are sampled periodically to establish the seasonal variations. In areas where there are strong currents and wide temperature variations, denser sampling and more frequent observations should be made in order to obtain an accurate pattern of sound velocity variations.

PLANNING AND DEVELOPMENT OF SMALL-CRAFT CHARTS¹

By James F. Richardson, Civil Engineer, Office of Cartography, United States Coast and Geodetic Survey

The explosive growth of recreational boating during the past fifteen years has pointed up the need for a special nautical chart to satisfy the safety requirements of our pleasure boat operators. This large and growing segment

of our population embraces the novice as well as the seasoned navigator and all types and sizes of pleasure craft.

To meet this need, in April 1958 Rear Admiral H. Arnold Karo, Director of the Coast and Geodetic Survey, appointed a committee to study the problem and make recommendations for a compact chart for small-craft use in inland and coastal waters.

¹ The original text of this paper, submitted by the United States of America, appeared as document E/CONF.36/L.42.

The responsibility of safeguarding valuable floating possessions of water enthusiasts and of helping them to get the most enjoyment and pleasure out of their investment is an important one. For a chart to be of maximum value it must reflect completely reliable information. It is a relatively simple matter for the motorist with his road map to orient himself, for he has landmarks and cultural features to guide him. The new chart series should provide the boatman with a waterway guide that will become his road map when he parks his car and boards his yacht. The small-craft charts represent the latest efforts, in the never-ceasing endeavour to improve the design of nautical charts, to assure maximum usefulness to the greatest number of potential users. Frequent innovations and inventions have always been compelling factors in Coast and Geodetic Survey charting programmes to meet the ever-changing and expanding need for more and better charts.

All vessels navigating the coastal waters of the United States and its possessions depend on Coast and Geodetic Survey nautical charts, coast pilots and tide and current tables for safe navigation. The engineers of the Bureau have combined these three publications into one format for the use of the small-craft operator.

For his own safety and the assurance that he will return to port, the boat operator must have information on the channels, the dangers, the times and range of the tide, the times of slack water and of maximum ebb and flood currents, and the location of navigational aids and radio facilities with their characteristics for identification. Up to now, the conventional nautical charts have been available to all boatmen, but to the small boater with extreme limitations on space, the size of these charts has been a handicap and the life of the charts is reduced through constant folding, exposure to the elements and lack of adequate stowage space.

The new series of small-craft charts was initiated by a detailed study of the requirements of pleasure-boat operators for nautical charts and coast pilot information. The assistance of the United States Power Squadrons and the United States Coast Guard Auxiliary was enlisted for this study and both organizations canvassed their membership by questionnaire to determine user requirements. The Power Squadron summarized replies from 5,000 operators, and the Coast Guard Auxiliary furnished complete questionnaires representing 2,000 operators.

Replies from some 2,000 boat owners in the US Coast Guard Auxiliary reflected 83 per cent acceptance for chart sizes ranging from 18 × 24 inches down to standard page size of 8 × 10½ inches. A purely mathematical average of suggested chart dimensions was 14 × 18 inches. This same high percentage desired coast pilot supply and facility information on the charts in preference to separate books.

Four experimental formats covering the Potomac River were designed to conform to the majority of the requirements and suggestions received. Two were folding charts and two were book type.

For comparative purposes, each series covered the same area and contained the same primary information. The four formats were developed in an effort to determine which was the most suitable or desirable.

Complimentary copies of these formats were sent to such organizations as the US Power Squadrons, the US Coast Guard Auxiliary, Outboard Boating Club of America, National Association of Engine and Boat

Manufacturers, marine dealers and many small-boat clubs. In addition, copies were displayed at various boat shows. Returns from about 35,000 mariners indicated their choice to be the Series B format, a four-panel folding chart with cover. This chart measures 14½ × 32 inches when unfolded, and 8½ × 15½ inches when folded in the cover. Many suggestions for notes and educational information were received during the period of compilation. The scale and format used for the base charts depend on the physical characteristics and boating pattern of the area to be charted.

It should be noted that the three experimental formats developed for the Potomac River and not now in use have not been discarded. It is likely as the programme develops that we will find it expeditious and necessary to vary the small-boat format according to the configuration of the water area for a particular district. There is strong sentiment, for example, for converting the standard size Intracoastal Waterway charts to an accordion-folded chart printed in one sheet on both sides of paper 15 × 58 inches long. By including facility and supply information on such a chart, it can be made to serve the needs of the small boatman as well as through traffic on the Intracoastal Waterway.

The following small-craft charts are now on issue: Series 101, Potomac River, Maryland, Virginia and District of Columbia, third edition; Series 140, Fort Pierce to Miami, Florida, second edition; Series 165, San Francisco Bay to Antioch, California, first edition; Series 184, Bellingham to Seattle, Washington, first edition.

User reaction to these charts has been extremely favourable, and they are very much in demand by small-craft operators. Unlike the conventional charts of the Bureau designed for use on the big broad table of merchant vessels, this handy folding chart is easily used on the flying bridge of a sport fisherman and in the limited space of the speedy outboarder.

It is difficult to write instructions for the construction of a small-craft chart since they can only be general in nature because the importance of the area, the pattern of traffic, the sunken and visible dangers therein, and the scale dictated by the compact format of the chart, all preclude the possibility of making any two charts precisely alike in character and scope. We can only strive for completeness, uniformity and simplicity in general appearance.

Source material for small-craft charts, except for revision photography and coast pilot data, is about the same as that used for our conventional charts. It consists principally of topographic and hydrographic surveys made by the Bureau and miscellaneous surveys made by other organizations. Since small boats can operate close to shore, in small creeks, or in very shoaly water, the Coast and Geodetic Survey is putting more emphasis on the closer development of these areas during hydrographic surveying operations. The cartographer must examine all source material and pay particular attention to the date of survey, geographic datum, depth unit, plane of reference, purpose and character of the survey and whether it is original or compiled. Original source material is used in the compilation of new small-craft charts and in the correction of existing charts. However, where a larger-scale conventional chart has been corrected from the latest available source material, a smaller-scale small-craft chart

is made directly from it, referring to original information, if necessary, to check questionable detail.

The cover is $8\frac{1}{2} \times 15\frac{1}{2}$ inches, printed on buff jute tag board. The remaining three sides of the front and back cover are used for tide tables and notes of particular interest to the navigator.

Small-craft charts are constructed on the Mercator projection. North may or may not be at the top of the chart as in conventional charts. New aerial photography is taken for each area immediately before field work for a chart is to begin. Topographic detail in the area is corrected from these aerial photographs. The topography at facilities is enlarged where necessary to represent the installations pictorially. A screen is used in lieu of the street pattern in urban areas and all through roads and highways are numbered and charted with a single line. The elevations are shown for tops of hills or mountains and additional landmarks are charted for close inshore navigation. The position, call letters and frequency of all commercial radio stations are charted. Clearfaced type, bold aid-to-navigation symbols and large compass roses provide easier reading of the chart. A heavy black line serves as border and neat line. Projection numbers are placed close inside the border and minutes of latitude and longitude are indicated by tick marks on projection lines in water areas. Graphic scales include nautical miles, statute miles and yards.

The density of soundings on the small-craft charts is less than that shown on our conventional charts. Soundings for the small-craft chart are taken from the largest-scale conventional chart covering the area, provided its scale is equal to or larger than the chart under construction. If it is not, the soundings are taken from the original survey covering the area. Care is taken in the selection of these soundings to show all shoals and deeps. The six-foot curve or the critical depth curve for the area is the only one shown.

For added emphasis and clarity, the following features are shown in red: facility numbers with leaders to the location of the facility on the chart; magnetic courses and distances; direction and strength of currents; limits of large-scale insets of active boating areas; storm warning stations; junction lines between charts in the series; screen to indicate red sectors at lights, and all features shown in magenta on the Bureau's conventional nautical charts.

Marsh and areas bare at low water are shown in green; water areas are blue-tinted to the six-foot or critical depth curve, and all land areas are shown in buff.

The back of this four-panel folding chart is used to show information of particular use to yachtsmen and pleasure-craft operators.

Each chart has a tabulation which provides useful information about the supplies and services offered by each marine installation in the area covered by the chart. Every facility is visited to determine exact location on the aerial photographs and approximate location on the present chart coverage, and to record the services and supplies

offered by each. During this inspection, other information is collected, such as local regulations, depths in the approach and alongside facilities, highway numbers and water depths in small creeks or privately-dredged areas. Operators of marine installations are usually familiar with their immediate boating areas and provide a great deal of useful charting information. Local US Coast Guard officers, US Coast Guard Auxiliary and US Power Squadron leaders discuss boating patterns, active boating areas, chart limits and local small-craft chart needs with us.

Facility tabulations are brought up to date yearly by the returns from questionnaires sent to each facility operator. The regular Coast Pilots are reviewed, and any information found which is necessary for use by small craft is shown by notes throughout the chart. A complete inspection will be necessary about every five years.

A study is made to determine the active boating areas for each chart, and large-scale insets on the back of the chart provide the scale needed for safe navigation. These areas are outlined in red on the front of the chart, where much of the detail has been eliminated to make it necessary for the mariner to use the large-scale insets.

Oblique photographs from seaward, printed in half-tone, depict selected marine installations, aids to navigation and topographic features. Low-level photographs taken from helicopters appear to be the most satisfactory for this purpose.

For easy reference and education of the small-boat operator, graphic whistle signals, fog signals, distress signals, weather information, radio telephone call letters and times of operation, basic rules of the road and abbreviations necessary for the use of the chart have been shown.

The chart index shows drainage, geographic names and other conventional chart coverage in black, water areas in blue and land areas in buff. The limits of each chart in the series are printed in red.

A chart series consists of three or four charts printed on high wet-strength or chemical wood paper similar to that used for the aeronautical charts of our Bureau. The charts are trimmed with a tab on one panel for mounting in a cover with a plastic clip. This type of mounting permits the users to fold the cover and other charts in the series out of the way for plotting courses on a flat surface.

New editions of small-craft charts are issued annually and are not hand-corrected between printings. Notices to Mariners warn boat operators of critical changes between new editions. This compact chart series provides small-craft operators with an instrument of navigation made to the same high standard of accuracy set for our conventional nautical charts. The small-craft chart is a substantial companion to the existing five series of nautical charts, classified as Sailing, General, Coast, Harbour and Intracoastal Waterway. It can and will become a handy reference to navigators on the bridge of commercial vessels when in inshore waters.

A NEW WORLD CHART¹

Background paper by the United States Navy Hydrographic Office

The Hydrographic Office is at present producing a revised edition of its Chart of the World in twelve sections. Two additional sheets covering the polar regions are planned for production in the future. A smaller-scale (1:39,000,000), one-sheet version of the world (H.O. 1,262A) is already available, having been issued in January 1961. The chart (H.O. 15,254) is scheduled for publication, section by section, during the fall of 1961. It is drawn on the Mercator projection at 1:12,233,000 scale at the equator and portrays in a generalized manner the earth's bathymetry and topography between 84° N and 70° S, with names of important features and places. The western hemisphere is centred on the sheet in order to show without interruption the Atlantic and Pacific Oceans. An overlap of 40 degrees longitude is provided in order to portray Arctic and Indian Ocean areas that are of interest to the major United States Navy Fleet Commands in the Atlantic and Pacific. When assembled and butt-joined, these sectional sheets will form a wall chart with dimensions of approximately 8 × 12 feet.

¹ The original text of this paper, submitted by the United States of America, appeared as document E/CONF.36/L.43.

The chart is published in colours, with topographic relief tinted in shades of natural brown and with bathymetry depicted in gradient blue tints at 500-fathom intervals beyond the 100-fathom curve layer. Appropriate symbols are used for showing the average annual maximum-minimum extent of pack and sea ice limits. Occupied IGY stations north of 70° south latitude are shown in red in the Antarctic area.

Of particular value to shipping interests are the preferred sea routes exhibited by red lines and labelled with correct distances in nautical miles between the principal ports. A graphic scale makes it possible to measure distances in statute miles according to the latitude, and clocks at fifteen-degree longitudinal intervals note the different time zones with respect to the Greenwich meridian.

The world's principal cities and seaports are symbolized, with the relative importance of places indicated by the size of the circle and type. Boundaries reflecting political areas as of 1 October 1961 are shown. For increased plotting utility, a one-degree grid appears on the chart. Auxiliary scale borders are also furnished to permit any sectional chart in the series to be reproduced at a selected scale and in finished form.

PHOTOGRAMMETRIC SURVEYS FOR THE PRODUCTION AND MAINTENANCE OF NAUTICAL CHARTS¹

Background paper by the United States Navy Hydrographic Office

To keep pace with ever-increasing maritime traffic and the consequent changes in ports and facilities, the production and maintenance of modern nautical charts require herculean efforts. A great part of this effort is directed toward coastal areas that suffer frequent change in cultural detail, including landmarks. It is here that aerial photography and photogrammetric techniques play their most important part. New aerial surveys and compilations account for only a small portion of world-wide chart production, but in nearly all instances aerial photography, if available, is employed to analyse or revise other source data.

The United States Navy Hydrographic Office makes every attempt to utilize up-to-date and well-controlled topographic data in the production of its charts. Aerial photography, as well as other source materials, such as topographic maps, port studies, ship visit reports and various documents, is continually being searched and analysed to provide corrections to these charts.

Where charted areas are covered by suitable maps at similar scale, cartographic agreement is generally achieved when a new edition of the chart is produced. Although such agreement is always desirable with relation to placement of features, it is not always necessary that the chart show the same density of detail. Small-scale charts show only a minimum of such detail, with emphasis on coastal and offshore items that provide aids and dangers to navigation. These consist of lights, buoys, rocks, shoal areas, landmark

¹ The original text of this paper, submitted by the United States of America, appeared as document E/CONF.36/L.44.

structures, pertinent elevations, etc. Large-scale charts and port plans reflect considerable topographic detail and therefore closely approach or equal corresponding map coverage as far inland as the first ridge line of relief. Aerial photography is employed to fulfil these requirements by making it possible to analyse the relative accuracy of topographic materials and update the information to the extent desired.

Requirements for new nautical charts which cannot be satisfied by available topographic or photographic materials are incorporated with long-range plans for new aerial photographic coverage and photogrammetric control surveys. Aerial photographic surveys are planned and specifications prepared by the Hydrographic Office, and the photography is flown by Navy photographic squadrons. These surveys are planned so as to acquire the photography in the most economical manner, that is, with allowances for rugged topography, unfavourable weather or cloud conditions and variable quality ground control. Each flight line is carefully plotted on the best map or chart available, and these are used during the inspection phase by the aerial navigators to make certain that requirements have been met.

General specifications for aerial surveys are published in Hydrographic Office Technical Specifications for US Naval Surveys and Supplemental Data, H.O. SP-4, 1961 edition. Specific project data, however, are prepared for each area, which provide such details as exact flying hours each day relative to minimum solar altitude, flight altitude, choice of cameras, and other factors peculiar to

the region. The resultant photography may vary, depending on the intended end product, between 1:10,000 and 1:60,000 scale.

Photo evaluation teams accompany the photo squadrons into the project area for the primary purpose of inspecting daily the photography as it is acquired. The team leader possesses the authority to alter the project specifications, as necessary, to meet unanticipated conditions. Although the complement of the team depends on the quantity of photography to be obtained, the general policy is to allocate one photogrammetrist per operating aircraft.

Stereo equipment is utilized by the photogrammetrist to make diapositives and set up stereo models in order to check for film flatness, contrast and quality of acceptance. Indexes are made in the field in accordance with the

Department of Defense Standard Indexing System, and copies are distributed to film libraries and to other mapping agencies. By agreement, duplicate negatives, prints and indexes are furnished normally to the country whose territory has been overflown by the photo-mapping aircraft.

Ground surveys are, of course, essential to supplement existing geodetic control. Specifications for these surveys are planned also at the Hydrographic Office. The supplemental ground surveys are made by photogrammetrists, who usually assist hydrographic engineers in establishing the primary net if hydrographic surveys are being conducted simultaneously or planned in the near future. General specifications for control surveys are described in H.O. Special Publication SP-4.

(b) Chart format and symbolization

NAUTICAL CHART SYMBOLS AND ABBREVIATIONS¹

Information paper by the United States Navy Hydrographic Office

A brief analysis of United States charting symbols and abbreviations in Chart No. 1, relative to the International Hydrographic Bureau (IHB) resolutions (Repertory 1919-1957), is given below.

A format providing for classification of 869 items is given in the 1959 issue of Chart No. 1.² Of this total, ninety-six are items inserted by the United States (shown with letters in parentheses) and which do not conform with any of the IHB resolutions. The remainder of the items (773) are listed in accordance with the IHB format.

Of the 773 items, 191, or 24 per cent (slanting IHB numbers), are items where no symbols and/or abbreviations, either IHB or United States, are shown but for which spaces are provided.

Items totalling 236, or 30 per cent of the 773 items, are in agreement with the IHB resolutions and are shown with vertical IHB numbers.

The remaining 346 items, or 46 per cent of the 773, show eighty-seven symbols and/or abbreviations which differ from the resolutions of the IHB, and 259 for which resolutions do not exist. These are also shown with slanting IHB numbers.

Of approximately 323 IHB resolutions, the eighty-seven,

or 27 per cent, to which the United States agencies do not subscribe, refer mostly to thirty-five buoy symbols for which the resolution prefers the pictorial method.

At present, there are several symbols for which modifications are being considered by the United States to bring them into conformity with the resolutions. Also, approximately five IHB symbols approved in the past are being reconsidered for acceptance by the United States.

Minor revisions are to be made in the next printing of Chart No. 1, in accordance with later IHB resolutions in Circular Letters No. 6 of 20 February and No. 10 of 27 March 1961.

The United States feels that the International Hydrographic Bureau presentation of symbols and abbreviations according to a standard form is one of the most valuable assets to cartographers and navigators in the history of chart making.

It enables the cartographer and the navigator of those countries participating in and using the standard form to interpret at a glance symbols and abbreviations of the other countries by comparing them with the symbol sheet of his own country. The important thing is that it does much to eliminate to a great extent the language barrier, thereby providing maximum convenience. Another advantage is that member nations have a means of being aware of each other's proposals or changes in symbols or abbreviations.

¹ The original text of this paper, submitted by the United States of America, appeared as document E/CONF.36/L.41.

² Published by the Coast and Geodetic Survey, United States Department of Commerce, Washington, D. C.

(c) Promotion of precise soundings for shallow waters and continental shelves

BACKGROUND PAPER SUBMITTED BY JAPAN¹

There exist, in Asia and the Far East, vast areas covered by shallow waters or continental shelves, where abundant marine resources are left undeveloped. Recently, various

public works, such as bridging and reclamation in the littoral districts, have been advancing rapidly in these areas. Moreover, it has been found that the submarine topography has, in coastal districts, important effects with regard to the disasters caused by typhoon and violent tidal waves.

¹ The original text of this paper appeared as document E/CONF.36/L.4.

Therefore, in order to achieve industrial development and to improve human welfare in the ECAFE region, accurate data on the bottom topography in shallow waters and continental shelf areas are needed for planning economic improvements and for the prevention of disasters.

At the Seventh International Hydrographic Conference in 1957, it was recommended that "hydrographic offices include in their programmes of work the carrying out of regular and systematic surveys of sea areas less than 1,000 metres in depth, it being understood that the sounding positions should be fixed with greater accuracy than that of ordinary navigation . . .".

From the standpoint of navigation, the data on precise submarine topography in shallow waters also becomes indispensable to meet (a) the increase of draught due to the increase of ship sizes, and (b) the need of sounding navigation of atomic submarine vessels for civilian use, which are expected to go into service in the near future.

It is, therefore, desirable that the countries having an

interest in this region promote precise soundings in shallow waters and continental shelves and exchange information on improved hydrographic techniques applied to these surveys together with the results of the surveys.

In Japan, the report of the Council of Science and Technology to the Prime Minister in 1960 on "Composite fundamental policy for the improvement of science and technology" refers to the necessity of preparing precise charts on the scale 1:50,000 to serve as basic maps for the sea areas around Japan containing shallow waters and continental shelves. The Hydrographic Office of Japan is carrying out this project with the preparation of about 500 sheets showing soundings with an accuracy of 0.1 to one metre. The spacing of the soundings will be ten to twenty millimetres at the 1:50,000 map scale and the accuracy of the position of the individual sounding will be one to two millimetres, also referred to the 1:50,000 map scale. About 20 per cent of the planned areas have already been surveyed.

A NOTE ON DEPTH WHEN THE BOTTOM IS SOFT MUD¹

By N. Owaki, Marine Research Laboratory, Hydrographic Office of Japan

As compared with cases in which the bottom of a port consists of sand or rocks, it is more difficult to determine a navigable depth where the bottom is soft mud, especially when the small particles are mixed with organic substances and form a coagulate mass. In such a case, the boundary of the mud surface is not well demarcated, and particles can float, well mixed with water, in the upper layers of sedimentation. In the deepest layers of the mud, the sediment is compact and hard, while towards the surface the water content increases, the density of particles per unit volume of the sediment decreases and its features change appreciably, becoming similar to a viscous liquid. This state may be referred to as "soft" mud. Thus, the deeper hard mud may be considered as elastic while the soft mud may be considered to be visco-elastic. Close to the boundary of the mud the particles are almost free, co-existing with the water as in a solution. In such circumstances, determination of the navigable depth presents a particular problem.

Two questions need answering: (a) what is the navigable depth in the case of the mud bottom, and (b) how can the navigable depth be obtained through an appropriate and efficient method?

First, the navigable depth must be defined from the standpoints of navigation safety and economy. Thus, the depth should be taken as deep as possible but not where a ship's motion is hindered by mud or where the bottom of the ship could be damaged by pressure from the sediment.

Such a depth must naturally be connected with the physical parameters of the mud at that level, e.g., the density of water. Thus, if we could know a critical density below which the ship's bottom would be damaged it would be possible to define the navigable depth as the level of that density. This investigation could be accomplished by some appropriate experiment on the motion

of a ship or model experiment of bottom damage through mud sediment.

A second problem is to determine the means for obtaining such a depth, that is, whether through echo or lead sounding. As is well known, echo sounding gives shallower values than lead sounding, especially if the bottom of the sea consists of mud formed by very small particles or organic coagulation.

Since there are some ports in Japan which have these peculiar bottom features, the Hydrographic Office has been interested in these two problems. The first preliminary investigation has been carried out in order to solve the second problem. Though the investigation is to be continued, we shall give here, as an illustration, some of the preliminary results obtained from investigation at a certain port. In this case, the demarcation between the hard or compact mud, which was rather elastic, and the soft mud was comparatively clear; there existed a region of a concentrated mixture of mud with water like a solution (figure 49). The depth was taken with lead and echo soundings, employing sound waves at frequencies of 14, 50, 75 and 100 kc/s. As expected, the higher frequencies gave shallower values, and the depths obtained by lead sounding were much deeper than any depth from echo sounding. Assuming that the critical depth coincides with the demarcation between the soft and compact muds, the depth at the 50 kc/s wave seems to show it. Figure 49 shows these relations, with the vertical distribution of the specific weight of the mud taken from the core sampling given on the left-hand side of the figure. The probable errors for the values of the echo sounding are on the order of magnitude of ± 5 cm. The differences in measured depths due to the frequency difference can therefore be regarded as significant.

This preliminary investigation revealed the possibility of obtaining the critical depth by a properly chosen wavelength. Also, we have tried to get the depth by lead sounding. For this purpose, we devised a special lead with a plate beneath it (marked A in figure 49), which correctly

¹ The original text of this paper, submitted by Japan, appeared as document E/CONF.36/L.4/Add.1.

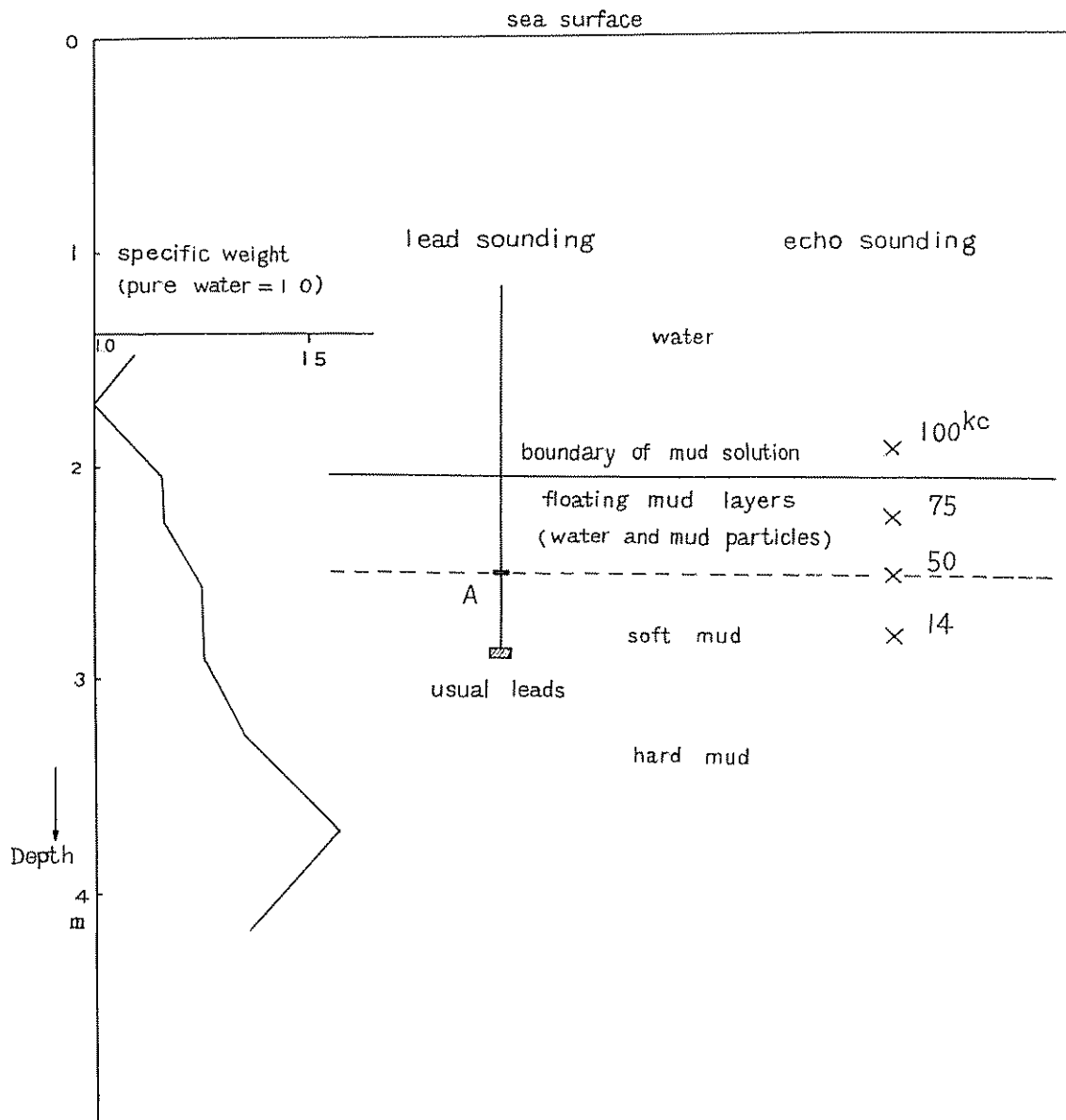

Figure 49. Determination of sea bottom features: Comparison between lead sounding and echo sounding

gave the critical depth. Since the depth obtained through echo sounding depends not only on the frequency but also on the intensity of the transmitted wave, we are now planning to get correlations of mud density and the depths obtained with various frequencies and intensities. It seems quite important to take the intensity into account for the purpose of determining the critical depth.

In conclusion, it seems very necessary to solve the two problems since for the first problem it is important to study what parameters (density, water content, hardness, etc.) will be most effective to determine the safety of navigation, and for the second it is necessary to investigate the possibility of obtaining a level in the mud sediment that is specified by a certain value of some physical parameter like density. Thus, it may be necessary in the future to specify definite frequencies and intensities employed for echo sounding, or to characterize shape, dimen-

sion and weight of lead, when the hydrographer measures the depth of water areas with soft mud bottoms of very fine-grain particles or containing a coagulating organic substance.

Before a definite method for obtaining navigable depth can be established, the following tentative ways might be proposed: (a) to employ sonic wave frequencies around 50-70 kc/s; (b) to make use of lead with a plate of the resultant basic pressure of the order of 0.01 kg/cm^2 beneath it.

It is, however, difficult to determine the depth even by these methods; in order to ensure the safety of navigation, therefore, it would be better at the present stage to recommend that all the depths to be shown on nautical charts should be measured with echo sounders with comparatively high frequencies (say, 100 kc/s) to give the upper boundary of the mud solution, and notice of the presence of floating mud should be given in the area concerned.

BACKGROUND PAPER SUBMITTED BY THE UNITED STATES OF AMERICA¹

Prepared by Commander Howard S. Cole, Electronics Officer, United States Coast and Geodetic Survey

REQUIREMENTS OF PRECISION EQUIPMENT

Precise soundings are of importance for an accurate hydrographic survey and to the user of the resulting chart. Precision is generally thought of as a measure of the perfection of measurement and is a quality independent of the purpose or conditions at the time of observation. Degrees of precision are allowed in some instances because conditions beyond our control make absolute precision impossible. In the promotion of precise soundings, the goal to be achieved is the best possible measurement regardless of the purpose intended. Be it for reconnaissance, charting, engineering or legal documentation, it is therefore proper that the precision requirements for shallow water be different from those for deeper waters such as are encountered at the outer limits of the continental shelf and beyond.

The shallow waters surrounding the continents and the islands of the seas contain many familiar features. There are the miles of mud flats and creeks, a variety of shoals and reefs, numerous islands and obstructions which, combined with sea life and sea vegetation, complicate the problem of designing practical precision depth sounding equipment. If equipment could be designed for only one set of conditions, the problem would be simplified; however, in actual practice it is important that any equipment be versatile and capable of good results over a wide range of field conditions.

The principal items to be considered in the design of a depth recorder for precise hydrographic surveys are:

1. Recording;
2. Depth range and scale;
3. Stability of sweep speed;
4. Sound velocity;
5. Sensitivity and stability of amplifiers;
6. Monitoring and method of calibration;
7. Operating frequency;
8. Installation requirements.

Recording

The recorder portion of a depth recorder is important to precision because it is here that the results are obtained. A piece of equipment with well-designed electronics but a poorly designed recorder is useless. The operator must be able to see the sounding almost as soon as it is written, especially in areas around shoals, where the safety of the vessel is involved. A record must be permanent and arranged so that proper notes can be placed alongside any features developed. There must be a method of keeping track of time so that the depth data can be rapidly and accurately related to the position of the vessel. All of the data must be shown clearly on the record so that it can be easily assimilated and evaluated.

Depth range and scale

In areas of shoal water, depths of less than one foot are often found. Soundings in such areas are difficult to obtain for two reasons: first, the limitation of the equipment and, secondly, the problem of navigating a craft

in such shallow water. It has been found that best results are obtained in very shallow water by using two transducers, one for transmitting and another for receiving the sound waves. A single transducer can be used successfully if water under the transducer exceeds four or five feet.

The range of some shoal water depth recorders extends from almost zero feet to two hundred and fifty fathoms. In order to present this wide range of depths on a scale where fractions of a foot or fathom can be determined accurately, a series of multiple overlapping scales is used. The advantage of the overlap is that the soundings are easier to follow when switching scales.

Depth recorders which use the overlapping scale method of extending the range often run into the problem of maintaining co-ordination between scales. Two methods of changing scale are available—one mechanical and the other electrical. The mechanical method presents a problem in that the pin used to locate the scale position and the slot into which it falls are both subject to wear. This causes an error in the recorded sounding which has to be corrected before the soundings are used. When an electrical method is used, the scales are changed by use of a switch which connects in pre-set contacts. The position of the contacts can be adjusted so that the scales are co-ordinated.

Another factor that affects precision in shoal water is the separation of the transmitting and receiving transducers. Whenever the depth is less than approximately ten times the separation of the units, the correction becomes significant in shoal water surveys.

If soundings are taken around such features as wrecks, channels and pinnacle rocks, the depth recorder must also be capable of a wide range of depths at a single gain setting.

Stability and precision of sweep speed

Echo sounding depth recorders are primarily time-keepers set up to measure the time it takes for a sound wave to proceed from the transmitting transducer to the bottom and return to the receiving transducer. The time the sound wave takes to travel this route is directly proportional to the depth. This makes it possible to calibrate the paper directly in units of depth provided the speed of the sweep which scans the paper is constant and proper, and the paper dimensions are stable.

There are different methods of obtaining the sweep. However, only a few have possibilities for precision survey work. The most widely used types are circular and linear sweeps. Two important variations of the linear sweep are the rectilinear, produced by a stylus band being uniformly rotated between two pulleys and the uniform rotation of a uniform helix. In very shoal water, experience of the US Coast and Geodetic Survey indicates that equipment using the circular-type sweep is the most accurate and dependable. The rectilinear-type sweep creates a problem in mechanics when applied to the high speeds required for good definition of soundings in shoal water.

The linear-type sweeps mentioned are most often used for precision recorders working in depths of over two hundred fathoms.

¹ The original text of this paper appeared as document E/CONF. 36/L 39.

To obtain the precision required for the various sweeps, the drive motor speed is controlled in several ways. One method is to use a synchronous motor powered from a supply source of frequency-controlled alternating current. Other equipment uses a governor to control the speed of a small direct-current motor. Using these methods, stable and precise sweeps are obtained for depth recorders for all depth ranges. However, for shoal water applications where high-speed sweeps are needed, the circular-type sweep driven by a synchronous motor appears to be the most reliable developed to date.

Sound velocity

The time that a sound wave takes to travel from the transmitting transducer to the bottom and return to the receiver depends on the velocity of sound in the water. This velocity varies depending on the specific gravity and temperature of the water in the signal path. This fact, although well known, is not always easy to take into account.

In areas where the water contains heavy silt, or where silt, fresh water and salt water are mixed or run in layers, the velocity in the signal path may be obtained only by direct comparison with lead line soundings, bar checks or a layer-by-layer analysis of temperature and salinity.

It is a common practice to use 4,800 ft/sec (800 fm/sec) for deep-water equipment and to make provision to vary the speed of the sweep on shallow-water equipment so that the speed can be set to a value close to that found by observations in the field. This tends to reduce the amount of final correction and is preferred by many hydrographers.

Sensitivity and stability of amplifiers

Echo sounding is often required under adverse conditions. Noise conditions in the water due to trapped air from heavy seas, mechanical noises on the vessel, sea life and other factors such as quenching, are involved. Quenching is a condition where in heavy seas ship motion is such as to produce a blanket of disturbed water under the transducer, which attenuates or completely blocks either the transmitted or the received signal or both. This leads to a requirement that our equipment be stable mechanically and electrically, and that the signal-to-noise ratio of the system be favourable. By narrowing the beam width of the transducer and decreasing the band width of the receiver a considerable amount of extraneous noise can be eliminated. Sea and ship noises are greatly reduced at higher frequencies, permitting highly sensitive amplifiers and operation in heavy seaway.

A troublesome factor is that some equipment exhibits a tendency for the soundings to vary as the gain of the amplifier is adjusted. This tendency can be reduced considerably by using the higher frequencies with narrow band transducers and wide band receivers.

Monitoring and method of calibration

Precise measurements require means of constantly checking the operation of the equipment. The two general factors which enter into over-all accuracy are speed of the sweep and the velocity of sound in water. Sweep speed can be monitored by a frequency meter giving the frequency of the supply to the sweep drive motor, a tachometer, or vibrating reeds that indicate speed of motor.

Methods of checking the over-all accuracy of the equipment are by "bar check" or vertical casts. Both of these methods will give a direct check on the total operation

and provide any correction factor that is peculiar to the specific installation and sea conditions.

Operating frequency

The choice of operating frequency is dependent on the work to be done. Equipment has been manufactured or conceived for operation over the frequency range of 8 to 200 kilocycles. In general, the lower frequencies are best for penetration of bottom silt, kelp attached to bottom, and for very deep operations. The higher frequencies have physical qualities that make them reflect from very small objects, such as silt on bottom, fish, etc. They also enable the designer to construct narrow-band transducers in a size that is practical for use on most ships and small boats. However, the higher frequencies attenuate rapidly and so cannot be used for deep-water sounding.

Installation requirements

Portability is a prime consideration when thinking of shoal-water depth recorders. Shallow-water equipment is used in small vessels and the deeper depths are probed by equipment mounted on larger vessels. The fact that shoal-water equipment is most likely to be used on a small boat points to the need for portability and small size. Although designed for small vessels, these portable instruments are used on the largest vessels when sounding in shoal waters.

To be truly portable, the equipment must be designed so that a satisfactory installation can be made aboard almost any vessel in a matter of minutes. In the interest of portability, equipment is designed for operation from 12 volts DC or some other low voltage likely to be found on a small boat. Another advantage is that if the vessel has no suitable 12 volt DC supply, a battery can be placed aboard.

The eight features discussed above can be applied to equipment for the deeper depths on the continental shelf. In general, the same features apply but, due to the deeper depths involved, the sweeps are longer and not as fast. Theoretical values are used for corrections because of the impractical aspects of numerous "bar checks" and vertical casts in very deep water — soundings are made in fathoms instead of feet, etc. These changes are allowed from the standpoint of relative accuracy as the fine degree of precision needed for inshore surveys is not required offshore, away from dangers, in depths not dangerous to modern ships.

Between the shallow water near shore and the outer limits of the continental shelf, distinguishing features or formations are often found that are of interest to the navigator and scientist alike. The interests of these two groups are different, but both require an accurate delineation of the ocean bottom. They include such features as sand ridges, deeps and shoals.

On the edge of the continental shelf depths may range from fifty fathoms to almost 2,000 fathoms. This requires more powerful equipment and a larger display record. The beam width of the transducers becomes important because the recorder record is a compromise composite of echoes and their reverberations along the ocean floor and other bottom acoustic highlights. Here, slopes and formations recorded have to be interpreted by understanding the actions of sound waves and their reflections if true depths are to be derived. Due to increase in depth, the precision of the timing devices must be increased.

Another aspect of the problem of obtaining precise soundings in the deeper depths is "how to be certain of the true depth". This comes about because some of the deep-water recorders use an automatic scale shifting feature. That is, the equipment automatically goes from one phase to another as the depth increases, a phase being the scale value of one time across the paper. Thus, a recorder which records in multiples of 400 fathoms could be in error by a multiple of 400 fathoms.

To get around this undesirable feature several methods have been derived. The simplest way is to use a stopwatch or actually to count the number of sweeps from the time the signal is transmitted until it is received. Some manufacturers, such as the Alden Company of Wesboro, Massachusetts, have incorporated a programme device in their equipment which automatically puts the recorder on an over-all deep scale at stated intervals. In some cases the problem has been solved by operating another depth recorder on a different acoustic frequency at the same time. If the second recorder is set on a deep range it can be used to determine the absolute depth on the precision equipment.

EQUIPMENT USED BY US COAST AND GEODETIC SURVEY

Since about 1940, the US Coast and Geodetic Survey has used a portable depth recorder, type 808, manufactured by the Submarine Signal Company of Boston. This equipment offers a record display of the soundings on about eight-inch paper. By means of four overlapping scales the range of the equipment is one foot to 160 feet or one fathom to 160 fathoms. Operating frequency is 21 kilocycles. It weighs about 95 pounds and is used with dual transducers. A combination of the two magneto-struction units can be installed in a wooden "fish" with weight of about 100 pounds. Other features are circular sweep, governor-controlled DC sweep motors, reed-type speed indicator and mechanical method of shifting scales.

This equipment, while it has some disadvantages, has been so successful that the US Coast and Geodetic Survey usually takes it as a standard in judging newer equipment. At the present time, very little use is being made of the "fish"-type transducer installation, most units being installed alongside the keel of a launch or in heavy castings set in the bottom for larger ships. For some launch, ship or skiff work, the transducers are simply laid in the bilge and covered with water.

The EDO 255 was developed by the EDO Corporation under contract with the US Coast and Geodetic Survey, to replace the type 808, which is now out of production. Many new features were incorporated in its design. Whereas the 808 uses a reed-type frequency meter to maintain and indicate proper sweep motor speed, the EDO 255 has meter-type indicators. The method of shifting scales was changed from mechanical to electrical in an effort to reduce co-ordination errors as the scales were shifted. Operating frequency is 37.5 kilocycles. Another and most basic change was from circular-type sweep to straight line sweep. A single transducer is used for both transmitting and receiving. Depth range of this equipment is from three feet to 250 fathoms. Changes in this equipment, which are now being tested, are designed to improve the shallow-water capability, the stylus writing accuracy and adjustment and the electric keying system and to make the change from feet to fathom operation much easier.

A new shoal-water depth recorder has been developed by the Raytheon Company under contract with the Coast and Geodetic Survey, and is known as the DE 723.

It is designed to be used in depth ranges of about one foot to 250 fathoms with acoustic frequency of 21 kilocycles. Equipment is packaged in two units of about fifty pounds each. Basic power is 115 volts, 60 cycle AC, which, for use aboard launches or other small craft, is obtained from a 12 or 24-volt transistor power supply. Other features are circular sweep, synchronous-type sweep motor drive and reed-type frequency meter to monitor sweep motor power input. Sweep speed and calibration can be varied by changing frequency of AC supplied to sweep motor. The US Coast and Geodetic Survey models use the same type of transducers as the type 808. The equipment can be obtained for use with barium titanate transducers, if specified.

The US Coast and Geodetic Survey uses the EDO 185 series of depth recorders in conjunction with the Precision Depth Recorder (PDR-MK-V) by Westrex, for precise soundings in the deeper areas of the continental shelf. This combination produces a record that can be scaled to within a fathom in depths from three fathoms to 4,000 fathoms or more. PDR-MK-V equipment uses nineteen-inch dry paper for recording, has a very precise time base and uses straight-line-type recording sweep driven by synchronous AC motor. The PDR equipment is substituted for the recorder portion of the EDO 185 in this type of installation.

Other types of PDR equipment are available. Some very complex types for oceanographic studies have a wide variety of scale and data input possibilities.

NEW EQUIPMENT BEING DEVELOPED FOR PRECISION

Looking to the future there is a need for better precision depth sounding equipment. If the various proposed programmes for world-wide coverage are to be practical, a certain degree of automation is needed to be able to present the vast amount of data collected in a form that is usable with a minimum of additional processing. To accomplish this service, rapid scanners for transforming the recorded soundings to digital form have been conceived and are under development. This will be a step in providing the input to an over-all data system. Equipment that gives digital depth information directly has also been under development. Efficient narrow-band transducers with a method of stabilizing them because of the ship's roll are needed where precise depths are required in deep water. There is the hope that more efficient and light-weight transducers will be developed for depth recorder purposes. Better and more rugged transistor power supplies for operation of portable depth recorders from a DC supply are needed in order to make the operation of this equipment on small boats more dependable and reliable.

EQUIPMENT PLANNED FOR NEW US COAST AND GEODETIC SURVEY VESSELS

The US Coast and Geodetic Survey plans to build a fleet of modern hydrographic and oceanographic survey vessels. It is planned to use the best depth sounding equipment available as the ships are built. Any developments in this field are being studied for present or future use.

Authorization for four ships has been made: one class I oceanographic ship and one class II and two class III hydrographic ships.

All of these ships will use the DE 723 shallow-water depth recorder on board ship and on the launches. Present plans call for the use of the EDO 185 and PDR-

MK-V on the two class III hydrographic ships. Equipment used on the other ships will depend on developments at the time specifications are written.

(d) Study of the representation of coastlines appearing in various charts and maps

BACKGROUND PAPER SUBMITTED BY JAPAN¹

Every country prepares maps, charts and aeronautical charts of various kinds, which represent the coastlines of those countries in accordance with their own definitions, e.g., at high-water level or mean sea level, without unified standards. Hence, there are sometimes differences between coastlines shown on different maps or charts covering a common area, which give rise to unnecessary difficulties.

At the Seventh International Hydrographic Conference in 1957, Argentina made a proposal to define the term "coastline" as the lower limit of the averages of the lowest ordinary low waters recorded in a given area over a long period of time, but this proposal was withdrawn after several opposing arguments were presented.

However, it seems desirable to give a clear definition of a coastline, and to depict the unified boundary line between land and sea in conformity with this definition. Therefore, it is beneficial to investigate the actual requirements for adoption of the definition of a coastline accord-

ing to the usage of maps and charts, and to consider the possibility of their standardization.

There may be three categories of elements to be considered in this definition of a coastline. (1) High-water line: this line represents the limit of land area of permanent emersion. The area, which may be covered by water even for a short time except in extraordinary meteorological conditions, cannot be regarded as a part of the land. A high-water line can easily be recognized by the limit of vegetation or the trace of tides, and surveyors can always trace this line since it always appears above the sea surface. This line, moreover, nearly coincides with the line defined as a coastline by geographers, e.g., by F. P. Shepard in *Submarine Geology*, 1948. (2) Mean sea level line: this line is significant in its "mean". (3) Low-water line: the level of this line is adopted as the chart datum, providing the smallest depth of water, and it is convenient for comparison with the draught of vessels. However, the low-water line can hardly be recognized without establishing at least a tidal cycle. Moreover, a rock which is sometimes covered and sometimes uncovered lies inshore of the line and gives the impression of a bare rock to navigators.

¹ The original text of this paper appeared as document E/CONF.36/L.2.

THE REPRESENTATION OF COASTLINES ON NAUTICAL CHARTS¹

By G. H. Everett and Lewis H. Evans III, Civil Engineers, Nautical Chart Division, United States Coast and Geodetic Survey

The charted coastline is the centre of interest on every nautical chart. To the mariner, the coastline is generally bordered by an area of shoaling waters in which his greatest dangers and hazards are to be found. It is also the area in which constant change is taking place due to the elements and to cultural developments by man. The mariner generally needs to make use of the charted features along the coast to verify his course and to aid him in reaching his destination.

The nautical chart differs considerably from the topographic map in its mapping of the coastline. In the topographic map, the emphasis is on the topographic features and the delineation of relief. The mean sea level shoreline on topo-maps is a very approximate delineation of the position of sea level at that stage of tide. To determine an accurate mean sea level shoreline would be a very expensive project which would cost too much for its utility value. The nautical chart is unique in its requirements for representing the coastline and it should be considered in a separate category from the topographic map in any discussion on this subject.

The representation of the coastline on the nautical chart is considered from the mariner's viewpoint and need. On the small-scale chart, which will be used in approaching a coast from the open sea, much characteristic detail of the coastline which would not be visible or which would be indistinct from several miles offshore is omitted. On these offshore charts the shoreline is generalized by omitting small configurations which are often characteristic of an area. On the large-scale charts, which will be used in close to shore, as for landing or entering harbours, inlets or rivers, the various features of the coastline are carefully considered for charting.

The compilation media for delineating the features are: line drawings on which the shoreline itself may be varied in meaning by symbolizing it; tints and screened tints; symbol patterns; individual symbols, and legends. Nautical chart symbols, as illustrated on chart No. 1 (USA), which are used on C & GS charts, were for the most part developed from earlier times. The history of many such chart symbols dates back to the time when surveys depended on the plane table and hand lead methods for obtaining the necessary data. They were designed for easy interpretation by the mariner and to furnish him necessary information for safely navigating the charted area. Geological distinctions are not important to the mariner.

¹ The original text of this paper, submitted by the United States of America, appeared as document E/CONF.36/L.45.

A complexity of symbols would reduce the legibility of a chart. Simplicity for rapid reading and ease in interpretation is important to good chart compilation.

The mean high-water line is the most prominent line on the chart. It is accurately determined by a special surveying project and is represented on the chart by a solid black line about 0.011 inch in width. If it is only approximately determined, it is shown by a dashed line which symbolically represents that fact. Such a situation might occur where formerly mapped shoreline has undergone great changes and, until the extent of change can be accurately determined, an approximation from best available information is charted. The MHW line is also emphasized by the fast land tint on the shore side and the contrasting shoal water tint on the other. Its configurations are important to the mariner navigating close to shore as it represents the most usual appearance of the shoreline. A rising tide is the best time to approach near to shore. An accurately determined MHW line will also represent many physical characteristics of the shore by the pattern it traces. The effects of prevailing currents, wave fronts and storms shape characteristic outlines on the different physiographic features of the coast which will be reflected in the charted shoreline.

Marsh or swamp are frequently found in low-lying areas that are inundated at high tide. Marsh is a feature that can be readily identified by a mariner and swamp is a feature that one would avoid if attempting to make a landing. The high-water shoreline for both features is used to delineate their seaward limit because, to the mariner, this limit appears to be the visible shoreline. The extent to which these features penetrate the back shore area is represented by a fine dashed line. The marsh areas on a chart will also appear in a green tint and, where space permits, may carry the legend 'marsh'. The green tint area stands out clearly against the fast land tint representing the characteristic break in the topographic background that marsh grass presents to the observer. The extent of marsh along the shoreline is usually accurately charted but the inland boundary may be greatly generalized as the ragged indentations into the fast land are of little importance to the nautical chart. The swamp area is represented in the fast land tint but with the legend 'swamp' or 'mangrove'. The vegetation of swamp land makes it appear as fast land and knowledge of its general location is sufficient for charting.

Seawalls, bulkheads and other man-made structures on the shoreline are represented on the chart by the outlines they make against the water area. As the MHW line is drawn around open piers or structures projecting into the water area, the black line is reduced to a 0.006-inch line. A fast land tint is overprinted on these features. These features are not labelled as they are readily identified by their shapes or by their proximity to other charted cultural features. Structures forming a part of the shoreline which extend out under water (such as marine railways or ramps) are represented by a dashed line for the portion that is under water at high tide.

The outer limit of the foreshore area is generally determined by hydrographic surveys. On a gently sloping coast, the area that uncovers at low tide may reach a considerable distance from the high-water line. This outer limit or low-water line is represented on the chart by a dotted line if it represents a sand or mud flat. To emphasize this area, it is also shown by a green tint on the chart. Within this foreshore area are often found the

effects of the seas cutting into the shore. Such features as scarred ledge rock and scattered boulders or rocks need to be charted. A ledge symbol pattern is used to delineate a ledge that uncovers, while the rock awash symbol shows the location of scattered rocks that will be totally covered at high tide but will uncover at some stage of tide. If the ledge extends below the low-water level, the use of sunken rock symbols or a foul area outlined by a short-dash line and labelled 'foul' will indicate the limits of the feature where it is considered dangerous to navigation.

Coral and lava rock, where located in the foreshore areas or in outlying reefs, are represented by the same symbol as ledge rock if they uncover at low water. They are seldom labelled on the chart, as all such features are the same as ledge rock to the mariner and are to be avoided. Coral and lava are generally found in areas where they predominate and in such places can be so interpreted from the chart symbol. Chart legends are generally used for describing conditions not practical for detail charting. The legend 'boulders' or 'foul area' may be used for shoal areas that are strewn with numerous rocks.

The back shore is a term applied to that part of the coast that extends inland from the high-water line to the marine cliff or bluff. Such a feature marks the limit of storm waters. The marine cliff or bluff is charted for its landmark value or if it borders the high-water line and is an obstruction to any landing operation. A visible cliff or landslide scar on a hillside would also be charted by symbol. The legend 'landslide' may be added if needed for positive identification.

The symbol used for rock outcrop or cliff is different from that used for a steep earth bluff. Both symbols are designed for ease of reproduction and do not indicate any particular height. They may be drawn, though, to indicate relative height. In so using them, they may slightly exaggerate the vertical view of such a feature on some charts. Their purpose on the chart is not to measure relief but to show the location of an erosion feature that can be observed and identified. Contours, if used on a chart, will end at the symbol.

In areas where the shore is lined by a ledge of bed-rock exposed by the sea, the bluff symbol along the HWL is omitted. The charted ledge rock indicates that cutting into the land is taking place and a low bluff at the shoreline would be expected. In this case the existence of the ledge is the important feature while the bluff is incidental. The bluff symbol is therefore omitted in order to emphasize the ledge symbol.

Reflected light from a strip of sand or the formation of sand dunes along the shore help to identify a locality as well as advertise a possible landing site. For these features a charted sand symbol is used for sand beaches. For gravel or rocky beaches the symbol is modified to indicate the type of beach. A general symbol for sand dunes is used, as a dune is continually changing. On a smaller-scale chart, the legend 'dunes' takes the place of the symbol.

A blue tint is also added for a selected offshore area adjacent to the foreshore, or the shore line. The outer limit of this area is a chosen depth curve. The selection of the depth curve varies according to the area charted and the type of chart. This tinted area emphasizes to the mariner the extent that the marine bench extends off shore. It is not a definition of the full width of the bench but it will generally comprise that portion which is affected most by deposition of sediment and erosion from waves. It is

the area where the long shore-bars, reefs and isolated rocks are for the most part located. The information for charting this area comes from hydrographic surveys. Field inspections determine the height that rocks will uncover at low water and this information may be added to the charted symbol of the rock. Surveys are more concentrated in these areas and from the configuration of depth curves and soundings charted many facts about the changes and shoal developments that are taking place along the coast can be interpreted.

New methods and techniques for mapping the coasts for nautical chart purposes are continually being developed. It can be expected that in the future more detailed knowledge of the coastal features will be made available for charting than was obtained in older types of surveys. Where greater detail is obtained, a need for modifying chart symbols and methods of delineation of features may arise. However, any changes or improvements in charting must always take into account the basic purpose of the nautical chart.

AGENDA ITEM 13

Topography and photogrammetry

(a) Review of new techniques and developments

AUTOMATION IN CARTOGRAPHY¹

Background paper by Erwin F. Gigas, Director of the Institute of Applied Geodesy of the Federal Republic of Germany

In the past, when a country had to produce a map, many years, often decades, were necessary to complete the task. Today, the need is more urgent. Large-scale maps are still needed for the greater part of the world; less than 2 per cent of the earth is covered by maps on the scale 1:25,000, and this after 150 years' activity in surveying and mapping. Only the most modern developments in electronics and automation can help us make up this map deficiency in a very short time, to satisfy the world's need for such large-scale maps.

One of the most indispensable tools is photogrammetry. It is not the purpose of this paper to report on the possibilities of covering, in a short time, those areas without a basic triangulation net by a net of marked points of sufficient density. The past years have shown many examples of this problem being solved by the use of electronic equipment. I wish to mention only two significant enterprises: the Shoran and the Hiran trilateration in Canada and Persia. But we should not forget the practical use of the first flare-triangulation in determining the azimuth of long distances, which is especially useful in trilateration nets covering large areas, or the use of electronic distance meters for trilateration and traverses, or the determination of the position of the camera at the moment of exposure by electronic means, or the methods used to obtain a higher density of the given triangulation by photogrammetric methods.

This report will try to demonstrate how the newly developed electronic computation and drawing equipment has already been used successfully in cartography and where the future will probably lead us.

In cases where a reliable map does not exist, a mosaic of air-photos can serve as a preliminary map. Mosaics of the old type used rectified air-photos which were not orthophotoscopic images. The errors which resulted from the shifting of objects in mountain areas by the central perspective reduced the value of these mosaics, which could only be considered as rough sketches.

The ingenious design of an orthophotoscope by Russell K. Bean of the United States Geological Survey, Washington, permits the conversion of the central perspective into an orthographic projection. This means that this instrument makes it possible for us to change the photographic images into a non-distorted map. Using the orthophotoscope enables us to start with a geometrical,

non-distorted mosaic, a real map instead of the former air-photo sketch.

During this meeting we have heard many details of this new instrument and we have also seen samples of orthophotoscopic air-photos. Some years ago I had the opportunity of seeing the orthophotoscope in Washington, and as a result of these studies the Institute of Applied Geodesy in Frankfurt-am-Main has investigated the possibility of using stereoscopic plotting machines of the optical type for this purpose as well, rather than just machines of the projection type. A differential rectifier is under construction which may be used in connexion with a Zeiss planigraph, or a Wild autograph, or with instruments made by Santoni, Nistri, Poivilliers and others, if these instruments are equipped for automatic scanning of the stereophotogrammetric model at a constant speed. But the scanning of the profiles of a stereophotogrammetric model takes longer than the photographic process of exposure which is continuously progressing point by point. For this reason we have inserted an electric store between the plotting machine and the photographic installation which allows the storage of the change in Z during the scanning procedure (see figure 50).

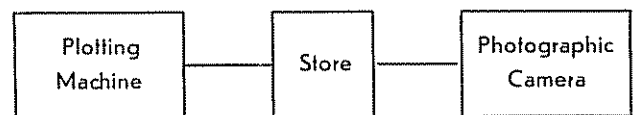

Figure 50. Diagram showing insertion of electric store between plotting machine and camera

The separation of the photographic procedure from the scanning operation has further advantages which will be illustrated later on.

We have found that the scanning operation is four times longer than the photographic procedure. By accelerating the photographic procedure, a more equal exposure of the different scanning lines may be obtained. Special equipment—comparable to Logelectronic—can be used during the photographic procedure to produce a contrast picture. Storage can be effected by punched tapes or by punched cards.

Another advantage is the possibility of using the punched tapes or cards in the production of several orthophotoscopic images. In such a case no operator

¹ The original text of this paper, submitted by the Federal Republic of Germany, appeared as document E/CONF.36/L.13.

is needed to work the plotting machine; the punched tape will steer the photographic camera.

One of the most urgent requirements in cartography is keeping a map up to date, and for this it is necessary to use photogrammetric air-photos.

If orthophotoscopic photographs are available, they can be put on to the map directly for the revision work, and we can then easily determine any modification of the culture and so correct the original plate. In Europe, we are of the opinion that photographic flights should be made every five years. If the information from the scanning procedure of the profiles is punched on tapes or cards, no operator for the plotting machine is required.

Figure 51 shows the photographic equipment. We see the well-known co-ordinatograph above which a

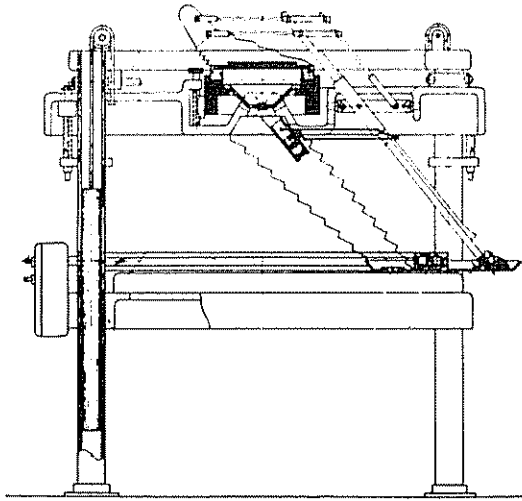

Figure 51. Diagram of projector for the differential reduction of distortion

camera is installed. The height of the camera can be varied so as to follow the Z-movement of the floating mark in the plotting machine. To obtain the highest-quality picture, the objective is automatically adjusted and thus always gives a sharp image. The photographic equipment can be installed in a separate room, preferably in a separate dark room.

If a map with contour lines already exists, these contour lines can be used to produce a punched tape for steering the photographic equipment. The contour map replaces the stereoscopic model in the plotting machine. An electronic co-ordinatograph may be used to evaluate such a map with contour lines. Instead of the drawing pen, we have a microscope which automatically scans the map at a constant speed.

After one scanning movement has been made, for instance in the Y-direction, an automatic movement in the X-direction follows, corresponding to the scanning width.

An observer has to operate the marker. Whenever a contour line is passed over, he has to push a button. Different buttons are used for falling or rising terrain. The work of the operator can be entirely eliminated if the contour map is prepared in three colours. Then it is necessary that the contour lines on the map be at basically equal intervals. Intermediate lines in plain areas have to be erased. The contour lines should not be broken by figures or symbols, because it is essential to have them uninterrupted. After the above preparation, the contour lines have to be coloured in a regular

sequence, for example, red-yellow-blue. Supposing, for instance, that the contour lines are at intervals of ten metres, and the zero line is drawn in red, the ten-metre contour line in yellow, the twenty-metre line in blue, the thirty-metre line in red, the forty-metre line in yellow, the fifty-metre line in blue, etc., then the microscope with micro-photocells can distinguish the sequence of colours and automatically determine whether the terrain is rising or falling. Rising terrain has a sequence red-yellow-blue, red-yellow-blue, falling terrain, red-blue-yellow, red-blue-yellow, etc. If the terrain is flat, two successive contour lines will be the same colour.

If such a punched tape is produced for all map sheets, it is possible to rectify automatically each air-photo differentially. If the air-photo does not cover the whole map sheet but only a part, we have only to insert the co-ordinates of this part—normally a quadrangle—into the computer. The steering of the photographic equipment will then use only that information which is contained within the quadrangle and skip those parts of the map which are outside it.

In many countries important research work has been done on performing cartographic procedures automatically. The basic instruments used for this purpose are normally electronic co-ordinatographs. A computer combined with a co-ordinatograph not only allows the point given by the co-ordinates on the punched tape to be marked on the tracing table, but also a circle to be drawn, or a triangle, or a quadrangle, as required, around the point and, furthermore, permits two points to be connected by a straight line or a curve. In this way, a cadastral map can be produced entirely automatically.

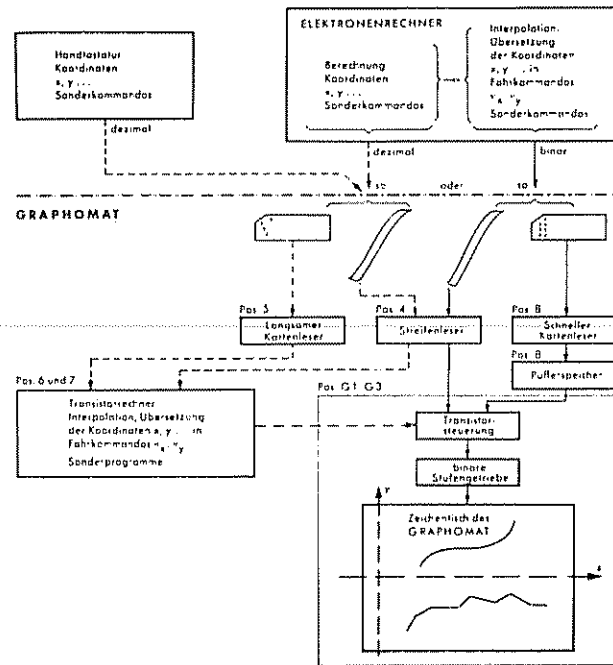

Figure 52. The Graphomat: Diagram of working procedure

It is very important that the drawing pen move quickly from point to point. The firm of Zuse, Bad Hersfeld, Federal Republic of Germany, has built a special instrument for this purpose called the Graphomat Z64, with an automatic gear shift. The maximum speed per second is 24 mm in each direction. If the drawing pen approaches

a point, the speed is automatically reduced. Twenty-four gear shifts are available and for each direction there are fifteen different speed steps.

The purpose of this gear shifting is to start at a given point at a low speed, to increase the speed to a maximum and to decrease it when approaching the next point. In this way the influence of inertia is eliminated and very high precision in the plotted co-ordinates is obtained. The smallest movement which can be carried out is 0.06 mm, or 0.0024 inch. The steering is performed by transistors.

By using different symbols for the various operations, the machine can be made to draw or to mark the point by a stroke. If the point is surrounded by a circle, triangle or other figure, the line connecting two points will start at the periphery of this surrounding circle and will end at the periphery of the sign of the second point. The arithmetic unit computes the difference in co-ordinates and the bearing of the connecting line. With these automatically computed data the line can be drawn.

The completely transistorized Graphomat Z64 can also perform conversion to other scales and eliminate distortions resulting from changes in the projection. If the drawing sheet is not oriented parallel to the axes of the co-ordinatograph, it is possible to convert the co-ordinates automatically to suit the position of the drawing sheet.

The computer can also calculate the orthogonal co-ordinates from polar co-ordinates. The margin of the sheet can be blocked out automatically and, by using the

formulas for interpolation, any curves may be drawn between adjacent points. The machine writes figures and names, draws symbols for woods, meadows, etc., and computes the surface features of a certain area. The plotting accuracy is higher than a tenth of a millimetre.

Figure 52 shows the scheme of the working procedure. The data can be read-in from a punched tape or card or can be put into the machine on a typewriter. It can also come directly from an electronic computing machine, in decimal or binary figures. The Graphomat has reading equipment for punched tapes and cards. If we have punched tapes it is necessary to go first to the transistorized computer for the calculation of such things as interpolation, transfer of co-ordinates, etc. With these data the orders for the rotation of the spindles can be established. These orders also contain information for numbering, scale reduction or elimination of distortions and so on. If punched cards are available, one can bypass the buffer store and go straight to the steering unit of the Graphomat. From here the drawing pen is directed by the binary gear shift.

It is possible to draw grid nets, margin lines, geographic grid lines, cadastral maps with boundary lines, traverses, etc., entirely automatically. We are even able to produce the culture plate of a topographical map automatically. An example of how a 1:25,000 map can be automatically developed from a 1:5,000 map is shown in figure 54 and table 1.

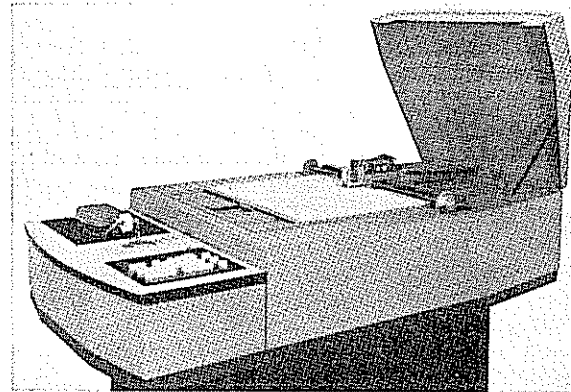
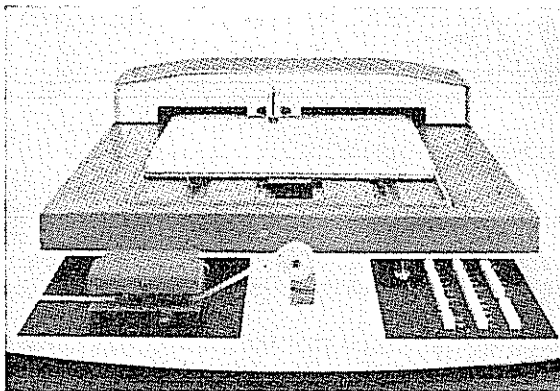
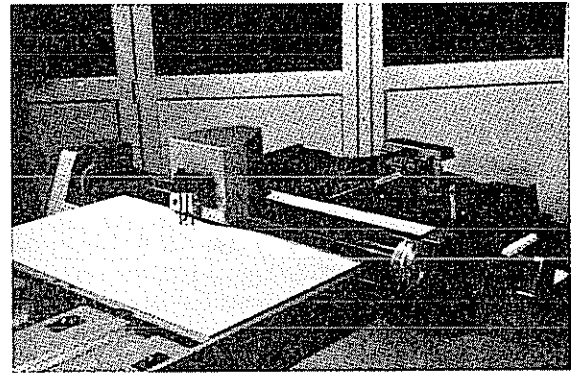
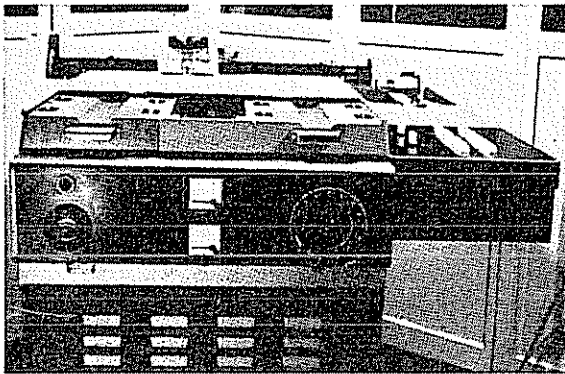

Figure 53. Photographs of the first model of the Graphomat (A and B) compared with the latest model (C and D)

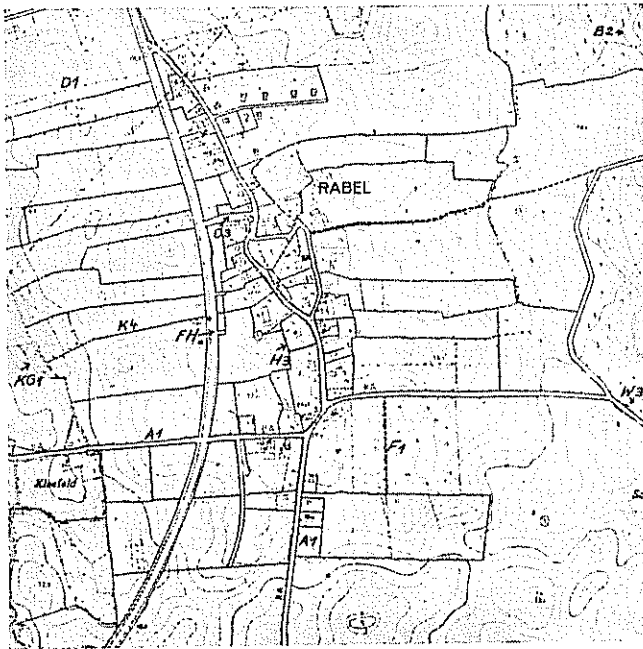

Figure 54. Example of reduction of map scale by use of the Graphomat

In this sample the main road can be described by only four points given in co-ordinates and representing the beginning and end of straight lines and circles with a fixed radius. Local streets, paths, boundaries of cultivation and so on are in most cases determined by only two points. Of course, there are other curves which will need ten or twenty characteristic points in order to describe them. But analysing the elements of the map always takes less time than the drawing procedure. Once such a programme is established, it is easy to transfer the data to other scales. In some cases it may happen that the generalization requires simplifying, but this is an easy task compared with the work connected with the usual generalization procedure.

The data can also be obtained directly and automatically if the map compilation is first drawn in a stereoplotting machine which is combined with a printer for co-ordinates, like the "Ecomat" of the Zeiss stereoplanigraph. The machine will indicate automatically the co-ordinates of the characteristic points at certain fixed distances and always when a change of the direction or the curvature occurs. The operator follows the roads, boundaries, etc. in the stereomodel, and all relevant co-ordinates are punched into a tape or card.

Certainly, automation in cartography will be limited to large elements of straight lines and regular curves. Complicated details, such as the approaches to the autobahn, or details in villages, will still be the task of cartographers in the future. But the development of other scales from the basic compilation can be carried out automatically for the greater part of the map. No mistakes can occur, and the work of the operator controlling the hand drawing is reduced to a minimum.

Automatic plotting can be traced back some fifty years to when the stereoaerograph of Oreil was built by Zeiss.

Table 1

	1:5,000	R (horizontal)	H (vertical)	Metres
FH	Federal highway 199	60,883	62,300	+881
		60,908	62,341	
		61,013	63,122	
		60,928	63,400	
O3	Street (village)	61,132	63,038	
		61,045	63,025	
A1	Loose surface road	60,700	62,635	
		60,721	62,630	
		60,817	62,647	
		61,079	62,661	
		61,211	62,667	
B2	Field and forest road	61,175	62,338	
		61,176	62,300	
		61,800	63,292	
		61,758	63,336	
F1	Trail	61,722	63,400	
		61,348	62,731	
W3	Creek	61,351	62,563	
		61,751	62,706	
K4	Low bank with hedge (quickset hedge)	61,800	62,724	
		60,778	62,788	
		60,857	62,828	
		61,059	62,868	
D1	Wire fence	60,700	63,223	
		60,962	63,281	
H3	Hedge	61,172	62,853	
		61,186	62,805	
		61,233	62,818	
KG1	Boundary of cultivation	60,800	62,763	
		60,767	62,765	
		60,733	62,820	
		60,700	62,817	

Automatic electronic machines are very expensive, and an effort has been made to make use of existing machines or parts of such machines. This has been accomplished almost perfectly by Zeiss Aerotopograph by providing the tracing table of the stereoplanigraph with several auxiliary instruments.

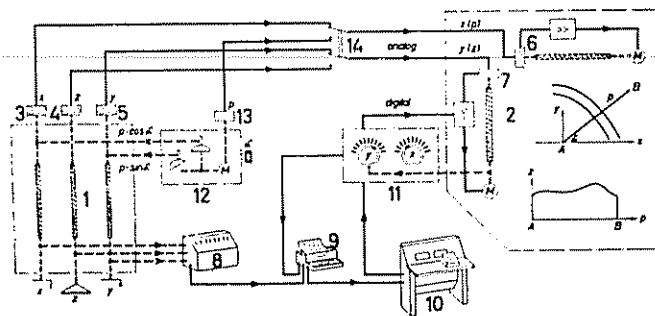

Figure 55. Diagram of the automatic plotting equipment of the Zeiss stereoplanigraph

Figure 55 shows the diagram of the automatic plotting equipment of the Zeiss stereoplanigraph.

In the diagram, (3), (4) and (5) indicate the three drive spindles for the plane co-ordinates x and y and the vertical component z of the planigraph (1); (2) represents the co-ordinatograph with its two spindles (6) and (7). The

axes (3), (4) and (5) represent the transmitters, (6) and (7) the receivers of a follower control device in which the revolutions of the spindles are the measuring and driving elements; (8) represents the well-known "Ecomat" for the registration of co-ordinates, (9) the automatic typewriter, which can also be used as a "read-in" unit; (10) indicates the commercial card punch to be used if the data are given in the form of punched cards; (11) is the coincidence unit. This unit receives the electric impulses generated by the read-in unit and processes them to the co-ordinatograph. The coincidence unit then checks whether the respective position of the plotting mechanism is in accordance with the stored values by comparison. In the beginning of the operation this will normally not be the case. At first, the differences between the x and y co-ordinates will be determined, and these differences produce the control voltages. The correct direction of rotation is determined by the fact that the differences between the co-ordinates have to become smaller. The control voltages are amplified and drive servo motors for the x and y motion.

The equipment described above allows one to draw a point automatically, or, if the pencil or the needle of the co-ordinatograph is moved to a plotted point, it is possible to print or punch the co-ordinates of this point.

For plotting a profile, the movement of the z spindle has to be transferred to the co-ordinatograph. This is effected by setting the selector switch (14) in its second position. Since profiles might be reduced against the x -direction by the angle a , a special profile computer (12) is needed to compute the product of the length of the profile and $\sin a$ or $\cos a$. The spindle speed values p and z are transferred by electromagnetic transmission over the selsyn switches (4) and (13) to the tracing table.

Zeiss has also developed another auxiliary instrument for automatic plotting, the "Co-ordimat". This means that the co-ordinate values read-in from punched cards or punched tapes will be plotted automatically in a given ratio by a point mark or one additional symbol. The connexion of plotted points by straight lines or curves and the lettering of the point are possible. The plotting speed and accuracy (0.1 mm) are reasonable. Since the speed is not variable as it is in the Graphomat, read-in from cards is preferred. By sorting the cards before the plotting process begins, unnecessary movements of the plotting pen can be avoided.

Figure 56 shows the Co-ordimat. In the figure, (1) is the tracing table, (2) the coincidence unit and (3) the card punch which is used at the same time as the read-in equipment. The control cabinet (4) contains a socket power unit, an interrogation unit and store, an amplifier unit, the control elements for the plotting mechanism and numerous control relays. After storing the read-in data in the coincidence unit, the plotting mechanism (7) is moved by the motor (5). The movements of (7), that is, the rotations of the spindles of the co-ordinatograph, are continuously reported to the coincidence unit through the shaft (6) and indicated there numerically to five places of x and y . The tracing speed is 40 mm/sec. With an average distance of five centimetres between the points, 600 points per hour can be plotted.

The Co-ordimat and the Graphomat will certainly prove to be valuable auxiliary instruments in the future and will help to overcome the great need for large-scale maps.

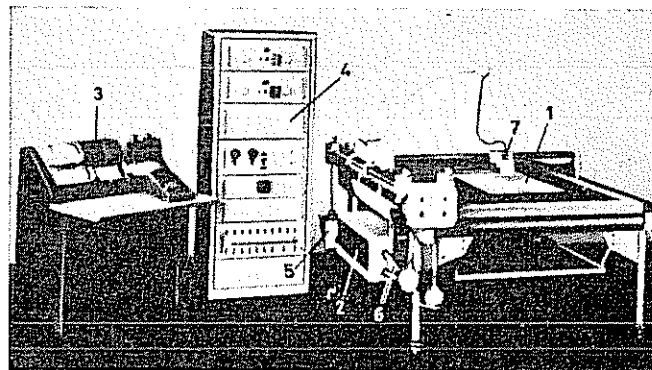

Figure 56. The Co-ordimat

During the past year automatic plotting instruments have found wide application in connexion with road construction. Zeiss Aerotopograph has developed a special profile attachment to the stereoplanigraph. This instrument permits profiles to be measured in the stereoscopic model and represented on the tracing table, with or without exaggeration or in figures, so that the co-ordinates may refer to a single profile or to a geodetic system. The profile computer is shown in figure 57. The angle

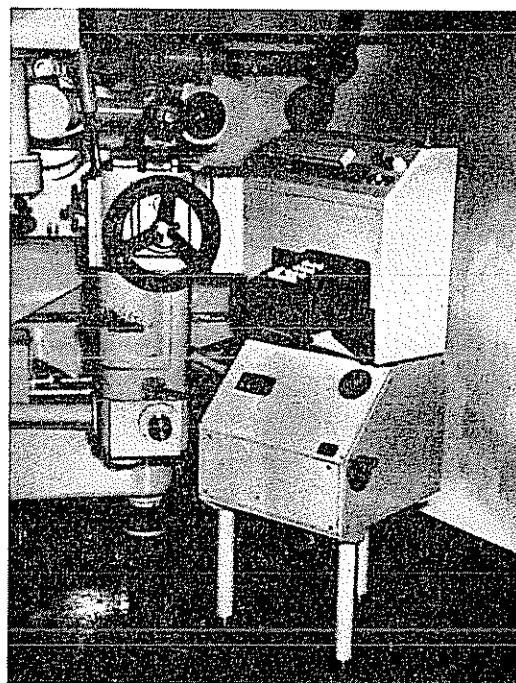

Figure 57. The profile computer

of the profile line to the x axis, which is known from the planning, can be fed-in with the handcrank (right) and is shown in the window with an accuracy of 0.1° . On the left, the shafts can be seen which have to transmit $p \cdot \sin a$ and $p \cdot \cos a$ to the x and y spindles of the planigraph. Above the profile computer, the Ecomat is visible. The operator can now automatically follow the terrain, and the profile is at the same time numerically or graphically recorded.

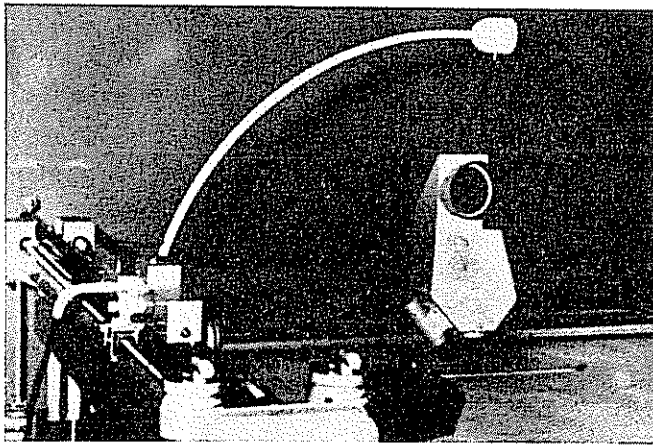

Figure 58. The Profiloscope

This instrument is an advanced construction compared with the Profiloscope, which is a kind of projector mounted on the ordinary carriage of the Co-ordinatograph instead of the plotting device. The operator can see the point on the plan and guide the projector to all the required places (see figure 58).

I have already mentioned that many scientists, firms and institutes are working on the problem of furthering automation in cartography. Waldo R. Tobler has recently reported in the *Geographical Review*, the periodical of the American Geographical Society, on the same subject. He describes the possibilities offered by thematic cartography and reports on tests to reproduce even shadow reliefs in maps by automation. The read-in of data can be effected not only from information delivered by punched tapes or cards, but also directly from plotted maps.

I shall not finish my paper without mentioning one of the most promising instruments—the Stereomat—developed in Canada by Mr. G. L. Hobrough of the Research and Development Division at Hunting Associates, Ltd., Toronto. This instrument permits contours to be drawn automatically and simplifies the compilation of cultivation, drainage, etc. The principle of this instrument is shown in figure 59.

Electronic scanning of corresponding areas of the stereophotogrammetric air-photos and comparison of the measured values of density allow the automatic guiding of the floating mark on the surface of the terrain. This

instrument will certainly prove to be very important, especially in countries with large open areas without forests.

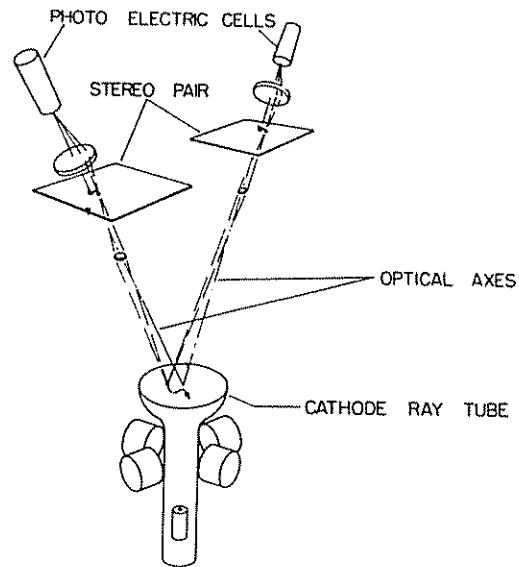

Figure 59. The Stereomat

After the contour lines have been compiled all other scales can be automatically developed. It is necessary that the contour lines be drawn in such a way that those which do not appear in the smaller scale are drawn with thinner lines. The Klimsch Variomat (figure 60) can then automatically delete such thin lines.

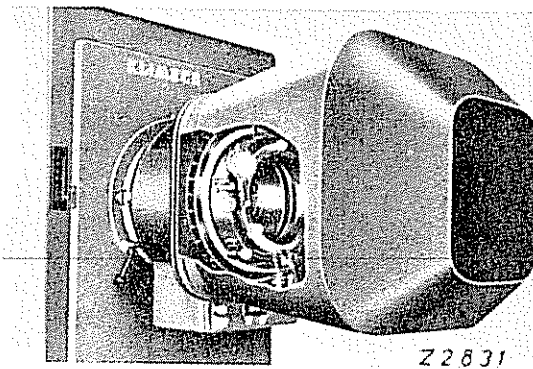

Figure 60. The Klimsch Variomat

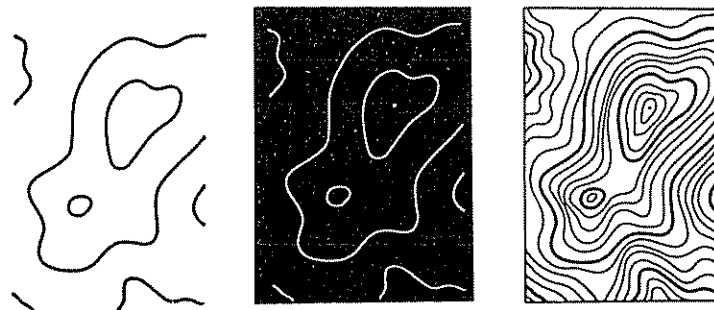

Figure 61 (a). Examples of results obtained by using the Klimsch Variomat for reproducing features of terrain

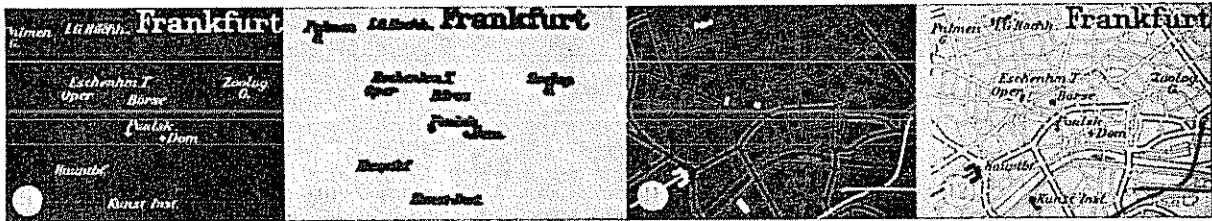

Figure 61(b). Examples of results obtained by using the Klimsch Variomat for reproducing lettering

The Variomat works by means of glass disks mounted parallel in respect of longitudinal and lateral movement, through which controlled shifting of the image may be obtained by varying the setting used. A thickening of lines is obtained when negatives are reproduced and a thinning when positive copies are exposed. Figure 61 (a) shows a sample of this procedure.

This instrument is also valuable for automatically removing the background of the lettering. Figure 61 (b) shows this procedure. From a negative lettering plate a thickened positive mask is produced and mounted on to the map negative. The background not required can then be erased automatically.

From many studies of international efforts to simplify cartographic work and promote it by automation, I have gained the impression that real progress is already evident and that the means and instruments so far developed will be a great help when work is planned.

An important problem at present is how to co-ordinate the production of the Map of the World on the Millionth Scale and the ICAO Aeronautical Chart on the same scale. It is easy to develop one map from the other without changing the projections. Let us think about these new possibilities. The existing shortage of qualified personnel calls for new methods and new ways and requires automation in cartography.

REFERENCES

- W.R. Tobler, "Automation and cartography", *Geographical Review*, 1959, pages 526 to 533.
- R. K. Bean, *Photogrammetric Engineering*, 1957-1959.
- K. Schwidewsky, "Bauelemente zur automatischen Kartierung", *Bildmessung und Luftbildwesen*, 1961, part 3, pages 156 to 165.

THE AERIAL MOSAIC—A VALUABLE PHOTOGRAMMETRIC AID¹

Background paper by H. Decker

The striving for perfection which is found throughout the entire field of geodesy as well as photogrammetry may sometimes be responsible for simple but effective methods and aids being relegated to the background or falling into oblivion. One of these aids in photogrammetry which is sometimes overlooked, occasionally rediscovered and still never quite exhausted, is the aerial mosaic.

Whether it consists of a single air-photo or is assembled from a number of photographs, the aerial mosaic is the genuine, original air-photo containing all the information which an observer in an aircraft can see with the naked eye. In addition, it can be supplemented in a simple way and to such an extent that it will offer considerably more information than an elaborate map. Like any aerial photograph, it will offer a perfect bird's-eye view of the terrain that cannot be obtained by any other technique.

Any photogrammetric job tackled should be preceded by the question whether the final purpose cannot be served just as well with a simple aerial mosaic as with a complicated map which requires a considerably greater investment in time and money.

First, a few remarks on the technique of producing aerial mosaics and the various kinds of mosaics.

It is generally known that in order to produce an aerial mosaic it is necessary to cover the respective area with a sufficiently dense control network. The methods available for obtaining this control network—such as aerotriangulation, slotted templet triangulation, terrestrial measurement or the use of existing maps—would need to be the subject of a separate paper.

It is also a well-known fact that the production of controlled mosaics is subject to certain limitations regarding the height differences in the terrain. This will be discussed later. As in the production of maps in a stereoplotter we must, in the case of the controlled mosaic, distinguish between mosaics at the small scales 1:20,000 to 1:100,000 for topographic purposes, and large-scale mosaics at 1:500 to 1:10,000 for planning purposes, as a basis for cadastral surveys, etc.

A small-scale mosaic can be produced only by the classical method with several photos being rectified in accordance with the control data available and assembled on the base-board to form a uniform mosaic. Planimetric differences in the various photos must be kept to a minimum at their edges by very careful assembly. The entire mosaic is then touched up photographically and provided with a legend and an appropriate margin.

One difficulty is the fact that the photographic paper will lose some of its stability during the development process. This loss of stability can be partly counteracted

¹ The original text of this paper, submitted by the Federal Republic of Germany, appeared as document E/CONF 36/L 85.

by the so-called wet procedure in which the photographic paper is soaked in a water bath with glycerine added, before it is exposed. Due to the addition of glycerine, the paper will keep a certain amount of humidity during the entire working process.

However, the use of dry glues in the dry technique has, of late, replaced the wet technique more and more.

Normal and wide-angle cameras may be used for the production of the photography. The use of ultra wide-angle cameras is not impossible; however, the extremely oblique viewing rays in the corners and marginal zones make it necessary to use only a relatively small portion in the centre of the photo. On the other hand, the short focal length offers certain advantages, particularly for small-scale mosaics.

Normal-angle cameras must be given preference in mountainous terrain or urban areas. The reason is the perspective displacements toward the edges of the photo, which will increase with decreasing focal length and increasing photo size. Even more pronounced is this projective displacement in the marginal zones of ultra wide-angle photography. As a consequence, the normal-angle camera will only yield a useful photo size of 12 cm \times 12 cm instead of the over-all size of 18 cm \times 18 cm, while 16 cm \times 16 cm may be used in wide-angle photography instead of the total size of 23 cm \times 23 cm. If we assume a maximum working ceiling for the photographic aircraft of 6,000 metres; this means that a photo scale of approximately 1:30,000 can be obtained with normal-angle photography, with a useful image size of 12 cm \times 12 cm corresponding to some thirteen square kilometres. The corresponding values for wide-angle photography obtained with RMK 15/23 camera are: photo scale approximately 1:40,000, useful image area 16 cm \times 16 cm, corresponding to about forty square kilometres.

Not only for this reason but also in order to facilitate the drawing operation, the basic and working scale for topographic mosaics should not be less than 1:25,000. If aircraft with a higher ceiling are available, or cameras of shorter focal length, the production of the mosaic can be made considerably more economical due to the smaller photo scale, but it will, at the same time, become considerably more difficult.

Under these conditions, normal-angle photography for small-scale mosaics can be enlarged 1.2 times and wide-angle photography 1.6 times in order to obtain a scale of 1:25,000. Sixteen normal-angle photos or four wide-angle photos are required for a map sheet with a side length of 50 cm.

As has already been mentioned, the photos are individually rectified and adjusted to the correct scale. They are then assembled on the base-board where they are also touched up, provided with a legend, etc.

Particularly in the case of mosaics for topographic surveys, the question will arise again and again of how far the photographic base plan should be supplemented cartographically. In any mosaic, regardless of its scale, the margin will be provided with a legend, a co-ordinate system, the name of the map sheet, the scale, etc. There can also be no doubt that towns and villages, water courses and mountains will, in the mosaic, be provided with their names. This lettering must be made in such a way that it will be easily legible even at smaller scales that might possibly be derived. The grid system may

be entered over the entire width of the map sheet or indicated only on the margin.

However, the clearness of a mosaic can be considerably increased by emphasizing the most important topographic features by map symbols. These are roads, railways, water courses, forests and, possibly, towns and villages. A mosaic provided with such symbols is called a "photo-map". The photo-map to a large extent combines the advantages of the aerial mosaic, namely, rapid production and completeness, with those of the map, rapid identification and clearness.

In any case, the cartographic touch-up should be modest, since the aforementioned advantages might otherwise become disadvantages. The value of a photo-map can also be considerably increased by representing the configuration of the terrain. The Stereotope is especially suited for this purpose. The Stereotope is a simple and inexpensive plotting instrument based on the principle of parallax measurement. The required planimetric and model corrections are introduced in the instrument by mechanical computers. If the planimetric correction is neglected, that is, if the photo-carriage is provided with a rigid tracing arm, perspective contour lines can be traced in the aerial photograph. Such lines are contours which are planimetrically correct in the aerial photo but which have the same perspective planimetric errors as the photo itself. As a consequence, the relative position of the contours with respect to the situation is perfectly correct. It is recommended that such contours be traced on a transparent foil and this foil superimposed on the negative during rectification. The contour lines will then appear in white on the rectified print. It is a disadvantage of this method, however, that the white contour lines make the mosaic appear very crowded. It is therefore better to make a negative of the contour drawing and to effect a second exposure after having withdrawn the aerial negative from the rectifier and carefully centred the contour negative. The contour lines will in this case appear in black. The print will then be much clearer.

Since it cannot be expected in the rectification that the contour lines will coincide without gaps, a strip of approximately one-half to one centimetre is left open along the connecting line of the control points. In this strip the contour lines are entered by hand on the basis of the overlapping plot. In the contour negative, this strip need only be covered with Chinese ink or adhesive tape.

In the case of rolling terrain it is recommended that the rectification be done by zones, that the area be split up into steps of various heights. Any excessive subdivision of the area should, however, be avoided, since the method will then become uneconomical. The limit should be three to four heights of steps. If this method does not give satisfactory results, other techniques will have to be used. If the use of stereoplotting methods is not desired, instruments of the orthophotoscope type may be employed.

A problem which usually turns up in connexion with such mosaics is the use of colours. In general it may be said that colours have proved unsatisfactory. Introducing colour does not contribute to the clearness of a mosaic; on the contrary, it will generally only lead to a reduction in legibility. However, it is suited for emphasizing special details as, for example, in the Economic Map of Sweden, where large parts of northern Sweden are depicted on mosaics.

For many tasks, such as the production of index maps of desert areas or virgin forests, we may even dispense with the photographic production of the mosaics. The few details available in such areas can—with the aid of aero-sketchmasters—be directly entered on the map sheet provided with control points. In that case, however, the drawing of perspective contours will hardly be worth while. If now and then contour lines must be plotted, it will be better to carry out the entire plotting in the Stereotope.

The second group are the large-scale mosaics. How valuable such mosaics can be was proved in Germany after the last war, when many maps were destroyed and existing maps were no longer applicable. In a well-surveyed country like Germany, this situation was so extraordinary that at first hardly any solution seemed to be possible. In this emergency, use was again made of the controlled mosaic.

The case of the large-scale aerial mosaic, which may be at scales from 1:500 to 1:10,000, may also best be approached through a brief discussion of production techniques.

In the case of the large-scale mosaic, unlike the photo-map, it is not only possible but almost necessary to produce each sheet of a collection of photo-maps from one single air photo. In a publication of 1954, Professor Kaspar elaborates on the advantages of this technique.

With the previously discussed technique, in which the mosaic is assembled from a multitude of single photos, certain discrepancies cannot be avoided during assembly. Above all, however, there will be a different perspective at the connecting lines of the photos. This may have a considerable influence on the legibility and the quality of the mosaic. However, if the entire mosaic is made of one photo, there is a guarantee of uniformity, even if there should be no increase in accuracy.

In addition, a useful negative size of 12 cm × 12 cm or 16 cm × 16 cm should, if possible, not be exceeded. For reasons of economy it seems best to use an enlargement of approximately three to five times for such large-scale mosaics, that is, a photo scale of approximately 1:30,000 for a mosaic of 1:10,000, about 1:20,000 for 1:5,000, about 1:8,000 for 1:2,000 and a photo scale of approximately 1:2,500 for a mosaic of 1:500. The aerial camera to be used should be selected above all with an eye to the type of terrain to be photographed.

In order to adapt the single photo to the frame of the desired map sheet, "pin-point" photography is recommended by Professor Kaspar in the publication mentioned above. Practical experience has shown, however, that a good team of pilot, navigator and photographer is required for this purpose—a condition which is fulfilled only in rare cases. Instead, it seems easier to select a high overlap ratio—if possible, one of 90 per cent. The exposure intervals will then be so short that we can always select a favourably located photo. And during the flight we need only watch out for perfect strip position. The cost of additional film required is negligible as compared to flying cost in general.

As a matter of fact, in the case of large-scale mosaics, too, perspective contour lines can be traced in the aforementioned manner in the Stereotope and rectified together with the aerial photo. This offers the advantage that even a superficial view of the mosaic will not only give us an idea of the configuration of the terrain but also of

the planimetric errors to be expected due to height differences. It is even possible to make corrections on measured distances, since in this technique the centre of the mosaic and the principal image point will coincide relatively well.

All the foregoing suggestions on lettering, touching up, use of colours and the like, are, of course, applicable also to large-scale mosaics. But let us now consider the question of where the large-scale mosaic may be employed to best advantage. In Germany, many mosaics were produced on a scale of 1:5,000 since it proved impossible to complete the German basic map 1:5,000—which was to become a base map above all for technical planning and cadastral work—in the required short period of time. It has turned out that such mosaics were not only able to serve as a substitute for the 1:5,000 map for general planning work, as index maps for road construction, etc., but that they were in some ways highly superior. The reason for this is that the mosaic

- (1) Represents the latest conditions corresponding to the photo date;
- (2) Gives a complete picture, and
- (3) Contains additional information.

These three points may be explained in detail as follows:

The mosaic represents the latest conditions. Because of the time required for stereoplotting from the aerial photograph, the final map may already be outdated by the time it is completed. Changing objects, such as gravel pits, wild torrents and even rapidly growing settlements, can never be shown up to date. The mosaic, however, may be available only a few days or weeks after the placement of the order.

The mosaic gives a complete picture. In any map, a selection is made of the details to be represented. Existing regulations indicate to a large extent what features are not to be included, while it will frequently be the operator who will have to decide about the selection of details. In contrast, the aerial photograph is a perfect and complete inventory.

The aerial photograph contains additional information. There are many details which cannot be included in the map within the framework of normal photography, such as the number of floors of buildings, differentiation of forests according to their heights, the position of particular trees or tree groups, etc. In the case of fields, differences of brightness in the aerial photograph will frequently indicate water arteries which are not contained in the map—an item which may be of importance in the study of an object. In this case, aerial photography may frequently do away with the necessity for an on-the-spot survey, or it may indicate conditions which would otherwise have been overlooked.

The most important applications of large-scale aerial mosaics are the following.

1. *Construction of roads and railways.* Here the mosaic may aid in preliminary planning for locating the road or railway. Under certain conditions, the preliminary location may even be made directly in the mosaic, if the mosaic were provided with contour lines. The mosaic may also be used for ownership identification in connexion with the purchase of real estate, and it may be employed as an index plan and as a basis for construction work.

2. *Hydraulic engineering and construction of canals.* Here also, the mosaic is a valuable aid for location and preliminary planning. It is logical that the elevation data to be obtained with the Stereotope are not sufficient for these purposes. However, the use of the mosaic as a basis for levelling will save the planimetric plotting of the terrain to be covered. The levelled elevations are entered in the mosaic and the contour lines are determined by interpolation, if necessary.

In addition, the mosaic may be of use for determining river damming areas, swamps and shore lines. It is indispensable for the surveying of shoals where terrestrial measurements are made impossible by the short intervals between high tide and low tide.

3. *City planning.* More than any other engineer, the city planner must struggle with the fact that his maps are never quite up to date. After the war, city planning in Germany faced the problem that, although there were city plans, one did not know which of the buildings were still inhabited or habitable and which of them had been destroyed. On the other hand, unregistered new buildings were constructed all over the town. In such a situation the aerial mosaic is the only aid for planning and supervision. If a shed is suddenly turned into a villa without permission being sought for the construction, this will be clearly shown in two aerial mosaics produced at a certain interval.

Numerous examples from other fields of engineering could be adduced. It is particularly valuable for all planning purposes if, in addition to a complete coverage of adjacent mosaics, the intermediate mosaic between two normal mosaics is made. It will then be possible to view stereoscopically each half of the intermediate mosaic with the corresponding portion of the neighbouring mosaic. Especially important areas may even be printed by the anaglyph method. This may prove of particular value for planning discussions and will make it possible to obtain a three-dimensional impression of the project without actually moving to the site.

As a final example of the application of large-scale mosaics, reference may be made to cadastral photogrammetry. It goes without saying that in this case as well the aerial mosaic must be limited to relatively flat terrain and that it can be employed only in areas in which the ground is of medium or low value. It cannot, of course, be used for urban areas divided into very small lots with a high soil value.

The purpose of every cadastral survey is the safeguarding of property lines and appraisal for tax purposes. The two factors involved in the appraisal are the surface area of the premises and their soil value. While it is

possible to determine the surface area with relatively high accuracy, the determination of the soil value is based on rather uncertain estimates. It is therefore important also to allow relatively large tolerances for the determination of the surface area of real estate for the purposes of the appraisal. A deduction of the values from the aerial mosaic will mostly be sufficient. In areas with small lots, semigraphical methods will be employed, i.e., the short sides of the premises are remeasured in the terrain, while the large sides are taken from the mosaic.

The aerial mosaic is also appropriate in the case of the second task, namely, the safeguarding of property boundaries. It hardly seems possible to provide a better guarantee for a boundary point than to include it in an aerial mosaic, where it can be easily redetermined on the basis of countless details. As a matter of fact, it is even better to signalize the boundary stones before the flight. But in all those instances in which the boundary is represented by natural topographic details and in which it does not follow a straight line, the aerial mosaic is ideal. In order to fix the boundaries, boundary stones and the course of the boundary are entered with red ink in an aerial mosaic produced on a non-shrink base, such as correctostat. Owner and lot numbers plus possibly the surface area are also entered. As a final guarantee, the distances from boundary stone to boundary stone may also be measured and entered.

Experience has proved that the layman will be able to orient himself better in an aerial mosaic than in a map, so that the recognition of boundaries by the owners of the premises—which has to be made on the basis of the mosaic in the terrain—will also be considerably facilitated.

If a reproducible copy is made of the original mosaic, the resulting copies may be used as additional working bases and as property documents for the owners. Since subsequent photos need be oriented only with respect to this original photo, it will be very easy to keep the cadastral mosaic up to date. Supplementary terrestrial measurements can always be based on local details and entered in the mosaic starting from such details. There can be no doubt about the fact that aerial mosaics require considerably less and less costly equipment than is necessary for the production of maps by stereoscopic plotters.

Finally, the type of reproduction used to publish mosaics depends solely on the number of copies required. While photographic or heliographic printing may be used for small numbers, offset printing will be necessary for larger editions. It is logical that the highest quality can be expected of photographic copies.

SCRIBING APPLICATION AT THE GEOGRAPHICAL SURVEY INSTITUTE OF JAPAN¹

PREFACE

Scribing was introduced into map production at the Geographical Survey Institute (GSI) in 1954. The investigation of base and coating materials obtainable from national markets was begun, and the first map made by scribing appeared in 1956. Since then, the scribing

system has been gradually applied to all kinds of maps and is now used in most map production at GSI.

The main objectives of the introduction of scribing into map production at GSI were the following:

- (1) To reduce man-hours;
- (2) To refine linework in final printed maps, and
- (3) To simplify multicolour map production.

These objectives are being achieved simultaneously

¹ The original text of this paper, submitted by Japan, appeared as document E/CONF.36/L.72.

through scribing. Indeed, man-hours have been reduced by 15 per cent in comparison with pen-and-ink drafting; linework has shown a pronounced refinement and the registration of multicolour maps is highly accurate.

GENERAL PROCEDURES

Scribing is the physical processing of the compiled or surveyed graphic materials on a manuscript into lithographic negatives from which offset printing plates are made. It is used in place of pen-and-ink drafting and photographic processing. Since a scribed sheet is equivalent to a lithographic process negative, it may be used directly to expose the printing plate.

A scribed sheet is obtained by scribing the coat on the translucent plastic sheet following the guide-image made on it. Scribing work is usually done manually with scribing instruments.

MATERIALS

At first, GSI used Polyloide (Polyvinyl chloride acetate) made by a domestic firm. Since 1957, Mylar (polyester plastic) has been used because this material is extremely tough, shatterproof and sufficiently stable, and its characteristics are regarded as the most suitable for detailed symbolization on the national basic maps.

Scribecoat, the coating developed by GSI, is composed mainly of asphalt, wax drier and solutions (volatile oils). It is of a transparent brownish-orange colour and the material is sufficiently soft for scribing detailed symbols. A sheet precoated with Scribecoat is now produced by domestic firms.

APPLICATION

Obtaining the guide-image for scribing

The compilation of a survey manuscript, which is used to produce the scribing guide-image, is usually in the form of an accurate, pencilled or Chinese-ink drawing, cartographically complete and final, lacking only the graphic refinement according to the map specifications. For revising an old edition where necessary, additions and changes are made with pencil or Chinese ink and unnecessary symbols on the old edition are deleted in dark green colour. In any case, the manuscript is now made on stable aluminium-foil drawing paper, "A. K. Kent", which is produced by a domestic firm. The introduction of translucent plastics is being investigated and they may be adopted as a base for future manuscripts.

Earlier, the guide-image was normally made on a very thin (0.75 mm) Mylar sheet and the press plates were exposed emulsion-to-no-coating in order to obtain normal right-reading positives as offset press plates. Since this exposure often produced poor press plates, from 1959 the guide-image was made as left-reading on a thicker (1.25 mm) Mylar sheet and the press plates exposed emulsion-to-coating. Now, the guide-image is usually printed photolithographically on the press plate directly from the manuscript.

Elimination of old symbols on a revised manuscript

In the past, unnecessary symbols were deleted with red ink and new symbols added with Chinese ink. Since, with this procedure it was difficult to distinguish the necessary features from the unnecessary on the guide-image, it was decided to cut off the unnecessary symbols with a graver; but this "cutting-off" work was exceedingly time consuming and required much patience and skill.

In 1960, a light blue opaque ink, which is not exposed on the wet collodion process negative used for obtaining a guide-image, was designed through the co-operation of GSI and a domestic firm. This special ink has been used to blot out the unnecessary features on revised manuscripts since 1961. It is expected that the introduction of such an ink will reduce working time by about 10 per cent and will also facilitate all of the operations related to revision.

Colour separation

The first step in colour separation is the processing of a duplicate image of the manuscript on the coating of Scribecoated sheets, the number of which depends on the number of colours to be reproduced. Each of the Scribecoated sheets may be scribed for a different plate for effective mass production. Stick-up work is used to indicate typography and individual symbols which are usually too difficult for manual scribing. The stick-up material is usually preprinted with translucent strip-film. These strip-films are generally made by photo-lettering machines.

If relatively few or uncomplicated letters are incorporated on Scribecoated sheets, such as a contour sheet, these may be scribed on to the sheet manually.

In the press-plate process, the finished stick-up sheet is used as a lithographic negative to be transformed into a film negative.

Area tints

Area tints, such as the tint within city outlines, the open water tint, etc., are produced on tint negatives by manual scribing or opaquing. Since these methods are not effective, a new strip-mask method is being tested and will be developed in the near future.

Proof colour separation

At first, since proofs were only made during the lithographic process stage, there was a considerable number of errors. In 1959, a commercial blue-print paper, already sensitized, and a table-type photo-contact printer were introduced. The printer employed ordinary ultra-violet fluorescent tubes as the light source and an air vacuum to enforce photo-contact between the original and the sensitized paper. It is of ordinary map size and is usually installed near the drawing room. The blue-print paper is used as a proof of registration for all colour separations by multi-time exposing. Moreover, certain gradations of colour can be made by changing the exposure time. Thus, the tint area may be lighter than the linework. Since errors are now less frequent than before, editing is easier and proofs are usable in the field.

Registration at blue-print proof stage

It is exceedingly tedious work to register each sheet in making blue-print proof by multi-time exposing. For precise registration, proof sheets are punched in each corner for proper positioning. When any of the sheets are registered, the corresponding punched holes must coincide with small cylindrical brass rivets, which have been designed by GSI.

GSI scribing instruments and accessories

The following are the domestic scribers most in use by GSI.

(a) *Y-type rigid scriber*. This scriber is currently used at GSI to scribe easily single-line work. It is made of duralumin.

(b) *Pivot swivel scriber*. This scriber is designed for a smooth swivel, is simple in structure and easy to maintain. The swivel mechanism is made with pivot axes and is quite responsive to any change in direction of scribing. It is very small and light, and can be used to scribe double lines.

(c) *Heating scriber*. The heating scriber is of a pen-type design and is intended for scribing dotted lines, such as boundaries. The needle point is heated with an electric heater within the body of the instrument. The scribing is done by rapidly touching the Scribecoat sheet very gently. This scriber is also effective in scribing linework. The prototype of the heating scriber is a rigid tripod with heating needle.

(d) *Rectagraver*. This tool is designed for semi-automatic design of building symbols. The following procedure is used: push the head of the needle, scribe the rectangle symbol, loosen the needle, which will then automatically spring back to its former position. The screw at the other side of the needle allows the movements of the needle to be adjusted.

(e) *Other instruments and accessories*. The needle points used at GSI are drill lots made with high-speed steel. The sharpening of needles is done roughly by a special sharpening machine and manually by adjusting the scriber on a sharpening stone.

Magnifiers used in scribing are 20×, 40× and 70× depending on the type of linework, needle point, etc.

An original pen-type graver, rigid-tripod engraver and symbol templets and foreign-made engravers, such as the ring type made in Switzerland, are also used. The ring-type engraver is excellent for scribing intricate details.

CONCLUSION

Scribing is now a standard process for preparing colour separations for topographic map production at GSI. It is also used for other kinds of map production. For example, it was used in the production of the map at 1:2,500,000 entitled "Japan and her Surroundings", a 1:1,000,000-scale map of Japan and for sheets of the Regional Map on the scale 1:200,000.

THE PRESENT POSITION OF ANALYTICAL PHOTOGRAMMETRY¹

Background paper by W. Schermerhorn, Director of the International Training Centre for Aerial Survey, Delft

SUBJECT OF DISCUSSION

At the 1960 Congress of the International Society of Photogrammetry (ISP) in London several new stereocomparators were shown, while in the scientific literature, analytical digital methods and the use of electronic computers tend to lead the way toward future developments. This paper is an effort to analyse the progress made in the development of digital methods, both as regards their precision and economy and in comparison with the classical photogrammetric methods. It also discusses problems of organization which must be faced by a service which wishes to adapt itself to the new methods.

INTRODUCTORY REMARKS

During the past few years new tools in the form of electronic and high-speed computers have been introduced into the world of map production. These are among the many new instruments, originally developed for other purposes, which have gradually come into use for geodesy, photogrammetry and cartography. It is very seldom that such new technical products are invented or originally designed for the needs of surveyors. This can be proved, for example, by following the development of a classical surveying instrument, such as the theodolite. Looking at the history of the optical micrometer theodolite, designed forty years ago by Dr. Wild, we find this instrument was built in a factory producing microscopes and physical and optical instruments, so that originally it was developed along the lines of the optical factory and not according to the requirements of surveyors. The same is true of computing machines, old desk machines as well as modern computers, all of which were originally built for other than geodetic purposes. Perhaps photogrammetry as such can be regarded as an exception in being developed especially for cartography, although we believe that

development for military purposes has had a great influence on this technique, not only during the war, but also in the past few years. Our task as geodesists and photogrammetrists is to adapt these new technical tools as well as possible to the solution of our problems. Because of the high cost of investment in many of the modern tools, and the limited size of the market, the computers and other instruments we use will, in most cases, have a multi-purpose character. Computers have developed along two different lines. First, there are the machines for administrative purposes, such as Hollerith and other punched-card systems. Then, for real computation, there are the electronic machines using punched tape which were designed during the Second World War. At present, many organizations use the same machines, such as IBM punched-card machines, for both administrative and scientific computations, although it must be stated that, for research organizations, special computers can have advantages.

In the design of new equipment, the factories use units of general application as far as possible. For co-ordinate registration, use is made of digitizing systems, which are also used for other purposes, for recording the position of a rotating axis or shaft. Such systems play an important role in modern photogrammetric equipment. We see in the SOM stereocomparator a Ferranti unit used for this purpose and attached to the comparator. Several commercial units are also in use in other apparatuses for co-ordinate registration.

PSYCHOLOGICAL INFLUENCES

We have the impression that the technique of the modern persuaders has made rapid progress in photogrammetry. There is a kind of myth about electronic computers and consequently about analytical methods in photogrammetry; even a kind of "press-the-button" faith, stimulated in part by the large organizations selling the computers which lead you to believe that you have only to obtain

¹ The original text of this paper, submitted by the Netherlands, appeared as document E/CONF 36/L. 28

some of their programmes to get in a few seconds those results which otherwise you would take years to compute by hand machines. It is even possible that in some cases a computer may become a matter of prestige to the buying organization, whether private or governmental.

The intention of this paper is to analyse the present situation and to determine both how much truth there is in all this and what precautions are necessary to obtain maximum benefit from electronic office tools at their present stage of development. Leaving other electronic instruments aside for the time being, we may now ask what use is made at present of electronic computers and punched-card machines. The original field of activity of the latter, administrative work of all kinds, is perhaps still the most important. We have the impression, perhaps because this is further from our personal field, that here these powerful machines render invaluable service with no difficulty.

AIM AND CHARACTER OF THIS PAPER

The question which interests us most is that of the application of these kinds of computers to photogrammetry, that is, how far digital photogrammetry is to be preferred to the use of analogue machines. After studying the present position, our conclusion is that there are today no data showing clearly a definite advantage of the analytical digital method over the classical one, from the point of view either of precision or of economy. This statement is not meant as a final evaluation of both methods; the aim is only to warn a productive service against taking a decision to enter a new field without a thorough knowledge of the consequences. There are publications giving results of the digital method for triangulation, but the data are still not sufficient to conclude that the precision which can be obtained by this method is either better or worse than that which can be obtained by the classical methods.

The actual difference in precision between the stereocomparator and a precision universal plotter is rather small. Looking at the values obtained from normal film photographs of between 10 and 15 μm , it is obvious that there are other sources of error more important than the instruments. Consequently, we cannot expect surprising gains in precision unless we can take into account these errors from other sources. If the gain in precision is not substantial, the next consideration is the economy of both systems. We will find that this problem is even more difficult, because of the lack of reliable data. In order to evaluate the present situation, we collected some data from the literature and from our own experience. The institutes which have so far published results are the National Research Council of Canada, Ottawa,² and the Istituto di Geodesia, Topografia e Fotogrammetria in Milan.³ Both use the Nistri TA 3 stereocomparator, while the Delft ITC uses the Wild stereocomparator Stk 2. Still older is the work of the British Ordnance Survey, using the Cambridge stereocomparator, which arrived at a production stage with this method even before 1960.⁴

² G. H. Schut, "Experience with analytical methods in photogrammetry", *Photogrammetric Engineering*, 1960, pages 564 to 570.

³ Giuseppe Inghilleri, *Theory and Practice of Analytical Triangulation*, Technical Paper No. 2, 1959. Istituto di Geodesia, Topografia e Fotogrammetria.

⁴ D. G. W. Arthur, *A Stereocomparator Technique for Aerial Triangulation*, Ordnance Survey Professional Papers, New Series No. 20, 1955. The introduction to this paper gives the history of the development of analytical methods in Great Britain.

Schut gives some results in "Experience with Analytical Methods in Photogrammetry".⁵ The only data which can be used for evaluating the precision of the results are the standard deviations in the residual y -parallaxes and the mean square values of the errors in height, if a sufficient number of check points per pair is available. These values should be expressed in microns in the plane of the negative.

In four models of the ISP Renfrew test the following results were obtained:

	m_{yz}	m_{py}
Average of all Wild A7 participants	12 μm	—
National Research Council, Wild A7 results	7	—
Nistri TA 3, carriers 1 + 2	12	15 μm
Nistri TA 3, carriers 1 + 3	13	13
Zeiss Jena comparator 18 × 18	9	7

In the same article, Schut gives results of three strip triangulations. The maximum errors in the co-ordinates of an individual strip, however, have no value for the evaluation of the precision of a method. They represent only one observation which allows no statistical treatment, except of the errors in individual models of such a strip. Unfortunately, only a very few publications deal with a large enough number of observations of the same or different strips (for instance, at least fifty) to justify any conclusion from closing errors or from parabolic deformations. The only two fulfilling this condition deal with the results of classical aerial triangulation. Consequently, it is still impossible to compare both methods of strip triangulation by means of co-ordinate errors. The only reliable and useful data at present are the standard deviations in the y -parallaxes and in the differences between co-ordinates of common points in successive models.

Schut gives the following data for three strips:

Scale of photography	Number of photographs	Type of stereocomparator	Number of points	m_{py} of points
1:40,000	95	Cambridge	9	10 μm
1:60,000	38	Nistri TA 3	15	9.3
1:40,000	49	Nistri TA 3	9	8.3

ITALIAN ANALYTICAL STRIP TRIANGULATION

In a publication of Inghilleri,⁶ explaining the method developed in the Politecnico di Milano, the author gives the results of one strip of twenty-six models. He uses a part of strip 2 A of Commission A of the European Organization for Experimental Photogrammetry Research (OEEPE) taken with RC5 film camera, scale 1:40,000, $c = 11.5$ cm. The mean square value of the residual y -parallaxes in six points per pair is about 5 microns, which is considerably smaller than in the Schut triangulation, where the same stereocomparator was used. It is strange that after transferring the scale in the nadir points, which makes $\Delta z = 0$ in this point, large systematic differences Δz between the z of successive models are found in the two wing points. Only five values are positive and forty-seven are negative, and the mean values for the two points are -0.83 and -0.65 ‰ of the flying height, corresponding to $px \sim 50$ μ . Also, the residual y -parallaxes have a systematic character. It is

⁵ G. H. Schut, "Experience with analytical methods in photogrammetry", op. cit.

⁶ Giuseppe Inghilleri, *Theory and Practice of Analytical Triangulation*, op. cit.

difficult to analyse these errors from the tables in the publication. Consequently, it is impossible to separate random and systematic errors for use in the evaluation of the analytical method.

DELFT ANALYTICAL TREATMENT OF LARGE-SCALE PHOTOGRAPHY OF THE OEEPE

A more reliable comparison is possible using the experiments of Commission C of the OEEPE. Although the photographs are taken with different cameras over different test fields, it seems that there are no indications of influences which make a comparison unreliable. The tests deal with large-scale photography, partly taken with Zeiss Topar film cameras $c = 21$ cm, and partly with Wild RC7 glass plate cameras, $c = 10$ cm. In each model such a large number of signalized points exists that the standard deviation m_p of the position of a point is a significant value.

Table 1 shows the results of an analytical treatment of 3×4 pairs taken over the Reichenbach test area. Measurement in the Wild stereocomparator and digital computation were carried out in 1960 by the International Training Centre for Aerial Survey, Delft (ITC), which acts as pilot centre for Commission C of the OEEPE. For the relative orientation, plate co-ordinates of nine pairs of two points are used. The absolute orientation is carried out with linear transformation using forty known points in each model. As a consequence of this abnormal number of known points, the residual errors can be considered to be due solely to observation errors and the deformation of the bundle of rays.

Table 1 shows in columns 7, 8 and 9 the resulting mean square errors in the three co-ordinates in centimetres.

Column 11 gives the mean square error in the planimetric position of all known points expressed in microns in the diapositive. A first conclusion from these figures is that there is no difference between the vertical Zeiss 21-cm film camera and the Wild 10-cm RC7 plate camera.

The Zeiss twin camera gives a somewhat larger value of m_{pz} , m_p and m_{pv} . This may be due to the fact that convergent photographs cannot be observed stereoscopically in the stereocomparator. The diagram with vectors of residual errors shows also a slight affine deformation of some of these models which would be improved by an affine transformation.

COMPARISON WITH RESULTS OF CLASSICAL RESTITUTIONS

The main question, however, is whether these results are better than those obtained from similar photographs with restitution in analogue plotters. We used for this comparison a number of pairs of the Oberriet test area of Commission C from the OEEPE Special Publication No. 3.⁷ We used those pairs for which the ITC improved the absolute orientation by applying an affine transformation with adjustment on all check points as known points. We do not believe that the difference between the use of forty known points for the Reichenbach pairs and 200-400 points for the Oberriet pairs will seriously influence the comparison. It is remarkable, however, that the value of m_p of the Oberriet pairs was decreased considerably by the affine transformation.

Table 2 does not give the data for all pairs published by Commission C. It is, however, from the point of view of this comparison a random choice determined only by the fact that ITC has today finished the new computation for these pairs. It is important that there are available a large number of pairs of photographs from the Wild 21-cm Aviotar film camera, which is similar to the Zeiss 21-cm Topar film camera of table 1. The reliability of the new results for m_p can be concluded from the much greater consistency in the same strip than in the original publication.

If we now try to compare the results of tables 1 and 2 we find that for the 10-cm plate camera m_p is $9.6 \mu m$ in both cases. This figure corresponds nicely with the

⁷ *Photogrammetria*, 1958/59, pages 141 to 148.

Table 1. Results of OEEPE Reichenbach Test: observation in the Stereocomparator

Strip	Camera	Height (metres)	Scale	Number of models	Number of points	$m_{\Delta x}$ cm	$m_{\Delta y}$ cm	$m_{\Delta z}$ cm	$\frac{m_{\Delta z}}{v_{opp} \text{ height}}$	m_p μm	m_{pz} μm	m_{pv} μm	m_{pv} μm
1	2	3	4	5	6	7	8	9	10	11	12	13	14
1.1	RMK 21-cm												
	Topar film	1,600	1:8,000	2	192	5.7	5.3	16.9	0.10	9.8	7.2	5.1	2.8
1.5		2,400	1:12,000	2	412	9.0	8.0	25.5	0.10	9.8	7.0	5.8	3.8
									0.10	9.8		5.4	3.3
1.3	2 x RMK 21-cm												
	Topar film	1,600	1:8,000	2	311	7.6	8.5	14.5	0.09	14.2	10.8	7.3	6.6
1.7	Convergent	2,400	1:12,000	2	542	10.0	10.0	21.0	0.09	11.8	11.0	8.2	6.2
									0.09	13.0		7.8	6.4
1.4	RC7 10-cm												
	Aviogon	800	1:8,000	2	154	5.0	7.0	10.0	0.12	10.7	6.7	6.6	6.4
1.8		1,200	1:12,000	2	305	6.5	7.5	13.7	0.11	8.2	6.0	4.5	4.4
									0.12	9.6		5.6	5.4

Table 2. Results of OEEPE Oberriet Test

(m'_{Δ_x} m'_{Δ_y} m'_{Δ_z} are mean square values of residual errors after linear transformation of the model on normal number of four to six points; m''_{Δ_x} m''_{Δ_y} m''_{Δ_z} the mean square residuals after affine transformation on all check points in a model)

Strip number	Camera	Height (metres)	Scale	Number of models	Number of check points	m'_{Δ_x} cm	m'_{Δ_y} cm	m'_{Δ_z} cm	m''_{Δ_x} cm	m''_{Δ_y} cm	m''_{Δ_z} cm	m''_{μ} μ m	m'_{Δ_z} of 100 height
1	2	3	4	5	6	7	8	9	10	11	12	13	14
1	RC5 Aviotar	1,000	1:4,770	20	1,583	6.4	3.7	6.5	4.6	21.8	16.4	12.4	0.16
3	21-cm film	1,800	1:8,660	5	1,378	14.6	8.9	12.2	9.2	29.8	25.3	14.8	0.14
5		2,600	1:12,400	2	338	9.0	6.4	9.5	6.9	20.5	17.3	7.6	0.07
												11.6	0.12
9	RC7 Aviotar	1,000	1:6,000	18	1,546	5.9	5.1	7.6	6.6	15.2	12.0	13.8	0.12
10	17-cm plates	1,850	1:10,900	6	1,101	12.1	7.8	13.5	8.8	23.5	20.0	10.9	0.11
11		2,650	1:15,600	6	1,625	10.5	8.8	12.3	10.1	35.3	25.8	8.6	0.10
												11.1	0.11
12	RC7 Aviogon	960	1:9,600	7	1,336	7.0	5.9	8.7	7.9	20.3	15.4	10.3	0.16
13	10-cm plates	1,400	1:14,000	2	307	7.5	6.9	12.0	10.5	19.0	12.6	9.0	0.09
												9.6	0.12

published Swiss⁸ and Austrian results, obtained with the same camera and ultra flat glass plates. It gives the impression that there is, somewhere around these 9 microns, a kind of threshold which we cannot pass, either with the precision universal machine or with precise stereocomparator measurement.

SOME UNANSWERED QUESTIONS

In the RC7 17-cm photographs of table 2 we find a stable m''_{Δ_z} in column 14 and an m''_{μ} which decreases with the scale. Comparing the 21-cm Topar of table 1 with the 21-cm Aviotar of table 2, it seems that the m_{μ} values are 10 and 12 μ m. Both are larger than the 9 μ m, although none of these differences is significant.

The main question in the comparison of the two previous sections is what is the influence of the affine deformation? A study of the coefficients of the affine transformation formula of strip 3 of table 2 showed the existence of affine deformation of 0.40 ‰ of the base length in the corners. Thus, it is possible that the reduction of m'_{μ} to m''_{μ} is not due to the greater number of passpoints, but to the affine transformation instead of similarity transformation.

Strip 10 shows the same reduction of m'_{μ} notwithstanding the fact that these are glass negatives. The same study of coefficients, however, shows that the three models observed in ITC do not show affine deformations and that the three Italian models show rather strong deformations, despite the glass negatives. Adjustment of the stereoplotter could be the cause of this.

The conclusion to be drawn is that the numerical treatment of the machine co-ordinates observed in ana-

logue machines should include affine transformation. The condition, however, is that we need at least one pass-point more than usual with similarity transformation.

Do we also need affine transformation for digital restitution? For film photography, without any doubt, though we did not use it for the film pairs of table 1. The vector diagram of residual errors for strips 1.1 and 1.5 shows no deformation. Consequently, the value $m_{\mu} = 9.8$ m can be considered final. Pairs 1.3 and 1.7 could perhaps be improved by means of an affine transformation. For glass plates it can be significant if the emulsion has moved over the plate.

Inghilleri⁹ arrived at the same conclusion at ITC, that is, that the photographic image determines the threshold of the precision which can be obtained. He observed and computed strip 2A four times and strip 1A' twice and each time found for each strip similar curves of residual errors after parabolic transformation on three groups of known points. The deviations have maximum values of twenty metres on 100-kilometre photography in 1:40,000. The irregularities over short distances are five to ten metres or 125-150 μ m in the negative. It is obvious that the 500 μ m of the maximum error in this strip is unacceptable for normal map production, unless there is a considerable reduction of scale from negative to map.

We compared the error curves of the strips 2A and 1A' of Inghilleri with those soon to be published for the same strip by Commission A of the OEEPE. The X and Y curves of the Milan Institute observed in the Santoni Stereocartografo have the same character, but the maximum errors for the analytical method are about half. For the height, however, they now found errors

⁸ W. Fischer, "Die Anwendung der Photogrammetrie in der Instruktionszone II der schweizerischen Grundbuchvermessung", Schweizerische Zeitschr. f. Vermessungswesen, 1959, pages 2 to 16.

⁹ Giuseppe Inghilleri, *Theory and Practice of Analytical Triangulation*, op. cit.

of the opposite sign and three times larger than in the classical method. I assume that they have used the same diapositives. For the strip 2A the errors of the four analytical treatments of Milan are several times larger than those of the only two institutes which applied the classical method. What has caused the large systematic errors in the analytical method? All the diapositives used for the experiments of Commission A of the OEEPE are made in the ITC in one cycle, using one duplicate negative of the film as original. Consequently, it is unlikely that considerable differences exist between the diapositives of strip 2A used in Milan, Vienna and Stuttgart.

ANALYSIS OF PRECISION BY MEANS OF BLOCK ADJUSTMENT

The publications of the British Ordnance Survey are of great importance. They represent the results of normal production. The Ordnance Survey considers the results of block adjustment and not those of the strips as decisive. The irregularities of 125-250 μm over distances of a few pairs as found by Inghilleri prove that the adjustment of a block with sections of one or two pairs as units is necessary to correct these. Major Simpson shows¹⁰ that with the application of the British system and of the ITC-Jerie analogue computer for least square block adjustment using ten control points in ten strips of a total of 145 pairs, the mean square error in fifty check points was 18 μm in X and 20 μm in Y. For the control points he found 9 and 13 μm . Such figures prove that this combination of procedures gives excellent results; they are in fact the best I have seen so far. It is very likely that the reseau camera has also contributed to these results. I do not know whether the residual *y*-parallaxes are correspondingly small.

ANALYSIS OF ECONOMY

A second point of comparison is the economy of the system. The basis for this comparison is the time required for observation and computation.

According to Inghilleri's paper, the total time for the analytical triangulation carried out by means of the Nistri stereocomparator TA 3 and the IBM 650 electronic computer is about forty to fifty minutes for each photograph. The time (in minutes) is distributed as follows:

(a) Computation of the general data on a desk machine	2.4
(b) Measurement of image co-ordinates	30-40
(c) Card-punching from tape	1
(d) Checking of data	2
(e) Computation of the strip geodetic co-ordinates	6

Other figures are published by the British Ordnance Survey.¹¹

Major Simpson gives: total time required for the observation and computation of strip co-ordinates per photograph—1½ man-days, equals about 10 hours; electronic hire per photograph—£2.2.0. Assuming that the cost of the computer is £10 per hour, this corresponds with a computing time of 13 minutes.

¹⁰ D. J. Simpson, *Analytical Aerial Triangulation in Practice*, Commonwealth Survey Officers' Conference, 1959.

¹¹ See footnote ⁴ above.

It is obvious that such figures have no common basis of evaluation. The Italian figures obtained in an experimental and research institute are the lowest known so far. The British figures are derived from normal production work. The difference cannot be explained solely by the use of different stereocomparators. In this respect we regret that there are no published figures from the United States for either economy or precision. Such figures could have helped to bridge the gap between the British and the Italian figures, in particular with regard to productivity.

We believe that it is certain that a service starting analytical triangulation cannot expect a production of over 2,500 pairs a year in one shift. We must also take into account the time during which either a part of the stereocomparator is out of order or the computer is not working. I know from OEEPE reports that trouble has also occurred in Milan. Furthermore, I have seen a recent report on computers in which a centre mentioned that after one day's work five weeks of repair were necessary, perhaps as a result of insufficient maintenance. The economy of these electronic machines can only be estimated on the basis of the results obtained during at least a six-month attempt to obtain continuous production. The real time per photograph can be calculated by dividing the total number of theoretical working hours by the number of photographs. Only in such figures is the lost time included. I assume that this is the method of computation of productivity used in the British Ordnance Survey.

As concerns our Delft experience with the Wild stereocomparator and with little more than a normal number of new and known points per pair, we arrived at the figure of about one hour per pair for observation in the stereocomparator. This is about ten minutes less than the same operator needs for aerial triangulation in an analogue plotter. That we do not need relative orientation in the stereocomparator is partly compensated by the fact that the measurement in images without proper relative orientation is more difficult and takes more time. We found that experienced stereo-operators need some special training on the stereocomparator before attaining full precision on this instrument. Furthermore, the analytical method requires the measurement of co-ordinates of the four fiducial marks of each photograph and of six special points for the relative orientation in cases where we use pricked wing points. This is normal practice with us because of the precise stereoscopic transfer of these points to adjacent strips. Only with the use of natural wing points can these also be used as orientation points.

It is an economic consideration whether the number of pairs to be observed per year justifies the purchase of a stereocomparator. A difference between this method and the use of analogue machines for triangulation is that the latter can also be used for plotting. If a service has only one thousand photographs to measure in a comparator, the instrument will stand idle during three-quarters of the possible production time (two shifts). Nevertheless, the instrument needs an expert technician for its maintenance, because of the electronics in the co-ordinate registration, etc. That is true also of similar tools in the plotter, but these will not be used solely for triangulation. In theory, it is possible to compute the number of pairs to be triangulated in a service before the purchase of a stereocomparator is justified. This is not,

however, an easy question to answer at present, nor will it be as long as there is no satisfactory explanation of the differences between the Italian and the British figures. For later plotting, however, we rely on the sketches or photographs of such points (Nistri TA 3 and SOM comparator).

PROBLEMS OF ORGANIZATION

Besides the considerations of precision and production time, the consequences of these methods for the matter of organization cannot be overlooked.

The most important consideration is perhaps the rigidity of the analytical methods. There is no flexibility, in the sense that if somewhere in the registration a mistake occurs—for instance, a number is not indicated as "0210" as it should be if four figures are used, but as 210—then the computer fails. The material comes back from the computing centre and the searching starts. After some time the mistake is discovered and if possible a check is built into the programme which ensures that the computer stops at the proper moment and does not produce nonsense. Such errors can only be avoided if the material for the input in the computer itself is correct. This requires a thorough study of each tape coming from the stereocomparator, correction of the errors and sometimes the making of a new copy of the tape. This is only an example of the many possible sins of the operators, which do no harm in a normal desk computation, where the man is not confused by the difference between 0210 and 210.

There are also other consequences of the blind nature of the operation, however. We had in the Reichenbach test four pairs of a Zeiss 15-cm Pleogon camera 23×23 cm. Of these, there were two pairs which gave bad results with the analytical method:

$$m_p = 38 m; m_x = 38 \text{ }^{\circ}/_{00} H; m_{pv} = 9.0; (m_{pv}) \text{ or.} = 7.5 \mu\text{m.}$$

The relative orientation proved to be quite good. For all 283 points we found $m_p = 9.0 \mu\text{m}$. What is strange is the large $m_{px} = 30 \mu\text{m}$ and the enormous values of the co-ordinate errors.

The model was repeated once in the stereocomparator, which produced a similar result, and then observed in two Autographs A7. The search has shown that in one corner extremely large residual errors occur, where something must have happened. The stereocomparator operator discovers nothing strange and uses a point in that corner for his relative orientation. The A7 operator cannot get rid of the p_v in that corner and tries another solution. He succeeds and will in many cases not even report that he experienced a difficulty which occurs from time to time. His pair shows within the passpoints no p_v of any importance and he reads the co-ordinates! In the analytical method, however, the trouble is discovered only after the computation comes back from the computing machine. If it is an aerial triangulation the strip is broken and even if the source of the errors is discovered, at least one and sometimes three pairs must be repeated. I proposed in Delft to use the analogue plotter to check pairs which come from the computer with bad results as this gives the possibility of checking p_v in an infinite number of points. There are not many such bad cases, but nevertheless they do exist.

The other side of this coin is that the analytical method is fully objective. The operator cannot be influenced by any condition which must be fulfilled by his readings, whereas the operator of an analogue plotter can mislead

himself and the service. Even the numerical relative orientation would only provide protection against this by automatic registration of the b_v readings or if the readings were taken by another person. What has been described as a disadvantage of the digital method proves in this way to be a positive quality. Besides this, we must realize that a relative orientation which has failed can be recomputed with other points if these new points are available in the model.

Furthermore, the analytical method requires a code which is strictly applied to all observations; otherwise the programme must be changed, causing considerable loss of time in the production.

We distinguish between a research institute and a productive service. The latter does not need its own computer, because even a medium-size computer has far too great a capacity for photogrammetry.

The programmes offered by the computer industry exist mainly for very general computations, such as computation of traverses, transformations, etc. In several institutes, private or governmental, however, more complicated programmes have been developed for highway engineering, special methods of aerial triangulation, adjustment of radical triangulation and different methods of block adjustment, but only a few of these have been published. For some of these methods either a financial agreement must be made with the authority which spent the money for its development, or each service has to start the same programming work.

There exists a great difference between productive services and research institutes. In the latter many different problems require a wide variety of programmes in the computer, so that in such institutes the programming section will be very important. Checking of programmes, which requires the computer for only a few minutes, will be a frequent operation. It is our experience at ITC that such institutes need to have their own computer at hand. It will not be used continuously, but if this is too heavy a burden for the budget, the machine can be exploited for other purposes.

CONCLUSIONS AND FUTURE

The conclusions reached above, may be summarized as follows. So far, the available publications justify no preference for either the classical or the digital method. When precision is the main consideration, the aerial triangulation of single strips is useless for the comparison. The comparison of large-scale photographs with signalized points shows that there seems to be a kind of common threshold, determined by the image itself, at about a standard deviation of $9 \mu\text{m}$ in the scale of the negative in the position of points.

As far as economy is concerned, we do not feel justified in drawing any conclusion. The difference between the Italian and the British production figures is such that there is no common basis for evaluation of the economy involved. The productivity of ITC stereocomparator operations during the past year is somewhere between the above values and is quite reasonable. The computation has hampered the production because the computers were not always available and they failed many times, thus making publication of productivity figures unrealistic.

The acceptance of the digital methods by a cartographic

service raises a number of problems of organization. It does not mean that the only change is that the old type of computation is now carried out in a high-speed computer. Transition to the new technique requires a new approach to all problems and a new kind of expert is needed, even where computer time is hired outside the organization. The digital method offers new possibilities. One of the important advantages is that photographs with all principal distances can be handled. In this respect the increasing use of super-wide-angle photography is a stimulus for the introduction of digital aerial triangulation.

Some of the new possibilities are not yet explored. Much research work remains to be done before the full advantages of this new method can be made available to the ordinary cartographic services. Those services, however, which cannot afford to plunge into this research should, for the time being, continue to use and to develop the classical methods. Naturally, exceptions may be made in the case of a service which so far has not used aerial triangulation at all and which now starts to do so, using super-wide-angle photography. It must be willing to accept the difficulties and forget for the first year at least the economy of the system. It should leave the difficult and expensive experiments to the pioneer sections of a few large productive cartographic services and to the special research institutes, which are adequately equipped for this.

As a result of all the problems and doubts mentioned above, our Delft ITC will carry out experiments on different stereocomparators and this year is obtaining its own medium-size Zebra electronic computer. This equipment is necessary in a research institute in order to contribute to improvement of the results. This means that we shall try to find out how the threshold previously mentioned can be passed, by taking into account various differences between the mathematical model and the physical representation in the negative. The advantage of the digital method is that these "corrections" can be introduced in the digital computation, whereas in the classical methods this is sometimes not possible. This, however, is only significant if the values which must be introduced in the computation for the improvement of the model can be determined in an economic way. It implies, for instance, that a much better calibration of cameras, a check of deformation of the image itself, etc. will be the unavoidable refinements of the photogrammetric procedure, necessary in order to exploit the possibilities of the digital method.

The research on organization problems will perhaps yield an improvement in the economy of the method.

Thus, we have ahead of us a great programme of research, before we will really have achieved the results that some photogrammetrists believe have already been obtained.

CONSIDERATION OF RECOMMENDATIONS OF THE UNITED NATIONS SEMINAR ON AERIAL SURVEY METHODS AND EQUIPMENT¹

By S. V. Griffith, United States Bureau of the Budget

REPORT

A complete report on the United Nations Seminar on Aerial Survey Methods and Equipment, held in Bangkok, Thailand, from January to February 1960, has been issued as a United Nations publication in the Mineral Resources Development Series.²

OBJECTIVES

The basic objectives of the Seminar were developed at the third session of the Sub-Committee on Mineral Resources Development of the Committee on Industry and Natural Resources held in Calcutta in 1958, as follows: (a) dissemination of basic information for resource surveys; (b) techniques and equipment uses; (c) applicability and limitations of techniques, procedures and equipment; (d) organization of such surveys, and (e) special problems encountered in the region.

SESSIONS

Information on aerial survey methods and equipment and many collateral surveying and mapping techniques, procedures and items of equipment were presented in technical papers and discussed in technical sessions and demonstration sessions during the Seminar.

¹ The original text of this paper, submitted by the United States of America, appeared as document E/CONF.36/L.31.

² United Nations, *Proceedings of the United Nations Seminar on Aerial Survey Methods and Equipment*, Mineral Resources Development Series, No. 12 (Sales No.: 60 II F 5).

SUBJECTS

The subject matter of the technical papers and discussions of the papers covered the subjects exhaustively. In some cases conclusions were deferred until such time as studies by special groups were completed and reported on. Technical papers were presented on the following subjects and the scope of the papers and discussions is also given.

Aerial photography—cameras and their characteristics, auxiliary instruments, photographic emulsions, film bases, flight lines, advantages and disadvantages of wide-angle and convergent photography, quality of photographic images, aging of lenses, gyro-stabilized camera mounts and infra-red and colour photography.

Photogrammetry and aerotriangulation—photogrammetric mapping at scales 1:20,000 to 1:100,000, graphic photo-plotting methods, slotted templates, stereocomparator and electronic computers for analytical aerotriangulation.

Photo-interpretation—for reconnaissance in geology, soil, forestry and water resource evaluation, use of photo-interpretation keys, negative scales of 1:20,000 and smaller, infra-red, colour and spectrozonal film emulsions and the training of specialists and scientists in their particular fields.

Air-borne geophysical surveys—air-borne magnetometric, radiometric, electromagnetic and gravimetric surveys, interpretation of results of air-borne geophysical

surveys, and employment of geophysical exploration companies.

Relationship between various branches of aerial surveys—this subject alludes to the interrelationships between various surveys. Because of the importance of this subject to the economic procurement of surveys, maps, charts and basic data collection, a special recommendation has been added to this report entitled "Sequential surveying and mapping programmes".

Regional problems and international co-operation—because of a lack of technically trained persons and limited technical training facilities in some parts of the region, it was recommended that:

(a) Fellowships be given for training outside the region, and

(b) A training centre within the region should be provided.

Note: it should be determined whether or not this matter has been referred to the fourth session of the Sub-Committee on Mineral Resources Development, Tokyo, April 1960, to which this report was to be submitted, and, if considered, what recommendations have been made.

Sequential surveying and mapping programmes—some of the subjects discussed during the Seminar were highly technical and involved very sophisticated instrumentation, which suggest a necessity to determine to what extent they may be applicable to the cartographic activities of a particular nation whose requirements, equipment and manpower dictate the need for the development of less technical and sophisticated instruments and procedures. A need to programme the cartographic activities in sequential operations to effect efficient and economical procurement of cartographic data is also suggested. For example, to mention some of the interrelationships: geodetic control needs to precede topographic mapping; topographic mapping should precede geologic mapping; geologic maps facilitate soil surveys and soil classification, and topographic maps also facilitate the mapping of soils and provide the basic information for many kinds of land use and land management studies.

It is recommended that the Conference consider the needs of the nations of the region and propose the kind of sequential cartographic programme that would provide the most feasible and economic procurement of survey, map and chart data for the needs of a typical nation of the region.

TELLUROMETER OPERATIONS IN TOPOGRAPHIC MAPPING¹

Background paper by Julius L. Speert, United States Geological Survey

ABSTRACT

The United States Geological Survey uses the tellurometer principally to increase the speed and reduce the costs of control surveys for topographic mapping. Increased accuracy is a welcome by-product. In this application, it largely replaces triangulation and transit-and-tape traverse. Most tellurometer work consists of traverse, with angles measured by a one-second optical theodolite. Second-order accuracies are obtained at lower costs than for previous third-order work. All traverses are tied to the basic geodetic net. Where geodetic azimuth ties are not readily available, azimuths are obtained from Polaris observations. Our basic traverse operations are supplemented, where appropriate, by a small amount of trilateration, numerous side shots or radial measurements from strategically located control stations, and triangulation intersections of conspicuous points. The tellurometer is also used effectively for testing the accuracy of finished maps. This report presents some statistical data on quantities, accuracies and costs, developed during our operations.

Data-reduction problems included development of a visual aid for interpreting tellurometer coarse readings and a plastic computer for obtaining the semivelocity of the radio wave in the atmosphere as a function of wet-bulb and dry-bulb temperatures and barometric altitudes. Vertical angle measurements are used to reduce tellurometer distances to horizontal and to sea level, and to compute elevations. The resulting geographic positions and elevations are adjusted by simple

proportion or by least squares, as appropriate. A programme was recently prepared for electronic computation of tellurometer surveys.

INTRODUCTION

Improvements in measuring equipment or techniques are generally intended to accomplish one or both of two major objectives: (a) to increase the accuracy of a particular type of measurement, or (b) to reduce the time and/or cost of making the measurement. It sometimes happens that a single development can accomplish both objectives, either simultaneously or alternatively. The tellurometer was developed to increase the speed with which high-accuracy geodetic measurements could be made. For this purpose it was intended to be competitive with triangulation methods. An apparent by-product of the original intent is its application to lower-order surveys, where increased accuracy is a welcome addition to the savings in time and cost.

UNITED STATES GEOLOGICAL SURVEY APPLICATIONS

The US Geological Survey has found the tellurometer well suited to several types of operation. Our requirements for basic horizontal control stipulate third-order accuracy. In open mountainous terrain, such as the western states, we have traditionally used networks of triangulation to locate control points at the required spacing density. In the central plains areas and in the eastern states, where triangulation would not be practicable without building towers to overcome the earth's curvature or where heavy timber cutting would be neces-

¹ The original text of this paper, submitted by the United States of America, appeared as document E/CONF.36/L.46.

sary to clear the lines of sight, transit-and-tape traverse has been used extensively. Most of the traverse lines have been run along roads for ease of accessibility.

With the tellurometer, both methods of control have been modified. Most of our tellurometer work consists of traverse; distances between stations are measured with the tellurometer, and angles between courses are measured with a one-second, optical-reading theodolite. Although our basic requirements call for only third-order accuracy, we find the tellurometer capable of producing second-order accuracy at no additional expenditure of time and effort. For this reason, we have improved our angle measurements beyond the needs of third-order work and are obtaining essentially second-order surveys at lower cost than for our previous third-order control. Since the theodolite is present at each station for horizontal-angle measurement, we are also measuring reciprocal vertical angles (or zenith distances) over each course. These vertical angles are used to reduce the measured distances to horizontal and also to compute elevations for supplemental control in the more rugged areas.

At least one end, and preferably both ends, of each traverse must be tied to the national geodetic network of first-order and second-order triangulation established by the US Coast and Geodetic Survey. When convenient, a starting azimuth is obtained by backsight on another triangulation station, and a closing check azimuth is obtained similarly. When geodetic azimuth ties are not readily available, azimuth is obtained by observation on Polaris. If the traverse is long or has many courses, additional intermediate Polaris observations are required.

On those relatively rare occasions when good tellurometer measurements can be made but stations are not optically intervisible because of atmospheric conditions, intervening foliage or similar obstructions, trilateration techniques may be used. This method is used, however, only when ordinary traverse methods are not practicable.

In the course of traverse operations, stations are sometimes located on high points overlooking large areas of the surrounding countryside. At such stations, side shots are made by measuring angles and tellurometer distances to other locations not on the main traverse line. A single, well-situated traverse station may thus be the central point from which a large number of control stations are located radially. Usually the side stations are established by single rays from the central station, sometimes by a spur traverse consisting of two or more courses.

When conspicuous natural or man-made objects are visible at a distance from several stations along a traverse route, it is not unusual to turn angles to such objects from several traverse stations to locate them by triangulation intersection.

Another important application for the tellurometer has been found in field-testing our finished maps to check compliance with established standards for both horizontal and vertical accuracy. The tellurometer is used most effectively in this application when one or more basic control stations are so situated as to provide a good general view of the mapped area. A theodolite and a tellurometer are set up at the controlling station and several roving tellurometers visit a large number of readily identifiable points shown on the map. Distances are measured to each of these points from the central

station, together with horizontal and vertical angles, from which the positions and elevations of the map features are readily computed to check the information shown on the map. These accuracy tests are made on only a specified percentage of our maps, on a sampling basis, and the tellurometer technique is used in only those open areas in the west where terrain and foliage conditions make it economical.

STATISTICAL DATA

The Topographic Division of the Geological Survey is organized geographically into four operating areas. Although the end product—the topographic map—is the same for all, terrain and other local conditions vary widely between, and often within, the areas. The field survey techniques must necessarily be tailored to local conditions and cannot be too thoroughly standardized. Similarly, a report on operating experience must reflect rather wide variations among the items included.

Our first tellurometers were delivered in 1957. After extensive familiarization, testing and evaluation by our headquarters staff engineers, selected engineers were brought in from each of the areas for a short period of intensive training and indoctrination. The equipment was delivered to our field personnel in the spring of 1958, one master unit and two remote units to each of the areas. Additional tellurometers were purchased at intervals since then. We now have thirty-four units in active field use.

Over 13,000 miles of traverse have been measured by tellurometer. Individual courses vary in length between one mile and ten miles generally, with an average length of three to four miles; but some lines of twenty to thirty miles have been measured when necessary.

Accuracies attained are indicated by circuit closures of closed traverse loops or by checks on first-order or second-order geodetic stations. These closures include the errors in the angle measurements as well as those remaining in the basic geodetic net after its own adjustment. (Some of the geodetic stations connected by tellurometer traverse are widely separated along their respective triangulation arcs.) Proportional closures average somewhat better than one part in 50,000.

The cost of this work varies greatly, according to local conditions and needs and the experience level of the operating personnel. Throughout the Division, the cost of tellurometer work, including transportation, reconnaissance, angle measurement, other related field activities and overhead, averages about \$124.75 per station, \$42.80 per linear mile, or \$7.80 per square mile of mapping controlled. These costs compare with average triangulation costs of \$217.55 per station and \$14.00 per square mile, and with average transit-and-tape traverse costs of \$78.70 per linear mile and \$10.60 per square mile.

DATA REDUCTION

One of the first problems we encountered in training new personnel was in the interpretation of the coarse distance readings. Some beginners have difficulty in visualizing the decade relationship that exists between the respective differences of the A pattern and the B, C and D pattern readings, whereby the tens digit of one difference helps determine the proper units value of the

adjoining difference. For this problem, we found a visual aid very helpful. We prepared a chart with four dials, each with a movable pointer. We then compared this series of dials with those on the familiar gas meter or electrical watt-hour meter and explained how a full revolution of the pointer on one dial produces a simultaneous 1/10 revolution on the adjoining dial, and showed the student how minor adjustment can be made in each of the differences to make them consistent without changing the over-all picture.

Perhaps our most significant contribution to the simplification of the data reduction problem was our tellurometer computer, for computing the semivelocity of the radio wave through the atmosphere. The original recommendation of the tellurometer manufacturer called for determining first the vapour pressure of the atmospheric moisture, then its barometric equivalent, then the index of refraction, and finally the velocity. We investigated various tables that were available from the Smithsonian Institution, the Bureau of Standards and the Weather Bureau. All the available tables require interpolation, usually in two directions. Although not difficult, the procedure was time-consuming. We considered various charts and nomograms that were available or could be produced easily. Then we discovered a semi-mechanical chart that had been prepared by the Naval Electronics Laboratory for determining the index of refraction of the air under various conditions. From the NEL report we extracted the combination of parts that best suited our needs and modified it to fit our own requirements. The final computer is printed on plastic. It consists of two parts, an opaque base and a transparent rotating sector. The base contains a series of spiral curves representing wet-bulb temperatures. Surrounding these curves are two semicircular scales, one representing the fourth, fifth and sixth decimal places of the index of atmospheric refraction, and the other showing one-half the corresponding velocity of propagation in feet per millimicrosecond. The sector has one radial scale for dry-bulb temperature, which rides over the wet-bulb curves, and a circular scale representing barometric pressure but graduated in feet of altitude because our field engineers use barometric altimeters instead of ordinary barometers. The two parts of the computer are riveted together at the common centres of the circular scales so that the sector is free to rotate.

In use, the dry-bulb scale of the sector is rotated over the spiral wet-bulb curves of the base to bring the two temperature readings into coincidence. Either the semivelocity or the refractive index may then be read on the base at the appropriate altitude mark of the sector. Thus, by a single setting of the computer, the semivelocity of the radio wave may be read as a function of wet-bulb and dry-bulb temperatures and barometric altitude. A number of minor approximations were made in the design and construction of this computer. The resulting read-

ings may not be adequately precise for the highest-order surveys, except at low barometric altitudes, but are well within acceptable tolerance for most practical applications. We believe that the computer is essentially as accurate as is justified by the quality of the meteorological measurements made and their wide separation in a non-homogeneous atmosphere.

Tellurometer slope distance is obtained by multiplying the tellurometer transit time, corrected for crystal temperature, by the semivelocity obtained from the computer. We have determined that the difference in length between the actual curved ray path and the corresponding chord is insignificant for the lengths and accuracies with which we are concerned. For reduction to horizontal, we multiply the slope distance by the cosine of the vertical angle, properly corrected for vertical refraction. Where reciprocal vertical angles have been measured, the mean of the two angles is the corrected vertical angle. We have found that altimeter readings are usually not good enough for reduction to horizontal if the difference of elevation is appreciable. The horizontal distances apply to the mean elevation of the line; they are reduced to sea level by the usual formulas. Again we find the difference between chord and arc to be insignificant.

Differences of elevation are computed as the product of slope distance and the sine of the corrected vertical angle.

To convert our tellurometer survey data to geographic positions, we first adjust the angle measurements. The convergence of meridians is computed and applied between azimuth ties to determine the amount of instrumental error. This error is then prorated among the respective angle measurements, and geographic positions are computed by the usual triangulation formulas. If the traverse consists of a single chain of lines, the position closure is prorated along the chain. If it consists of a network of loops or closed circuits, it is adjusted by the usual least squares methods. For this purpose we find our Electrical Survey-Net Adjuster (ESNA) very effective. The elevations determined from the vertical angle measurements are adjusted similarly.

We have recently prepared a programme to compute tellurometer surveys electronically on the Burroughs 220 computer. The programme computes preliminary geographic positions and elevations for traverses consisting of combinations of tellurometer and meteorological measurements, horizontal and vertical angles and/or horizontal distances measured or computed by other methods. Provisions are made for prorating azimuth closures, for offsets from occupied stations, for side shots, for spur lines and for closed loops. Various alternatives are available to the basic programme, and grid co-ordinates may be computed for any or all of the stations.

THE ARMY MAP SERVICE M-2 STEREOPLOTTER¹

Background paper by Donald E. Coulthart, United States Army Map Service

ABSTRACT

The operational problems and requirements which led to the development of performance specifications for a high-precision stereoplotter are presented. A description of the Army Map Service (AMS) M-2 stereoplotter and its operational characteristics is given. The test procedures used in the evaluation of the plotter and the results of the instrument test are presented.

One of the first assignments of the Photogrammetric Development Branch at Army Map Service was a comparative evaluation of the multiplex and the model 5020, Kelsh-type, stereoplotter. The results of this comparative evaluation, conducted in 1954, indicated that, under test conditions, the vertical accuracy of a single stereo model produced by the model 5020 stereoplotter compared favourably with that of plotting instruments of the highest accuracy. However, under operational conditions employing a relatively large number of plotting instruments and utilizing aerial photography secured with many different precision aerial cameras in the mass production of topographic maps, experience has shown that the vertical accuracies obtained under the test conditions were considerably superior to those obtained operationally.

The differences between the vertical accuracies obtained under test conditions and operational conditions were caused primarily by two factors. First, the radial distortion of the aerial photography used in the test project closely matched the average distortion of the Metrogon system, and the ball cams of the plotter were designed to compensate for this particular distortion. This is a condition rarely achieved under operational conditions, and any variation of the radial distortion of the aerial camera from the average radial distortion correspondingly affects the vertical accuracy of the stereo model. Second, under the conditions of the test evaluation, the plotting instrument was carefully calibrated prior to the establishment of each test model to ensure the proper alignment and function of the lens and compensating system. This procedure is not practical under normal conditions and can only be done periodically. Any malfunction in the system between calibrations is difficult to detect in a stereomodel and may only be indicated in the final product by the results of a geodetic field check.

The results of this comparative evaluation project spurred the preparation of performance specifications for a new stereoplotting instrument. The objective of these specifications was to provide an instrument of a higher order of accuracy which would retain calibration over extended periods, which would have a low initial cost and which could be manufactured in the United States.

To facilitate meeting the projected requirements of higher accuracy, ease of operation, low maintenance and low cost, a stereoplotter design of the conventional anaglyphic projection type, using a 9 × 9-inch diaposi-

tive, and "distortion free" projectors with no moving parts in the lens system appeared to be the most logical approach. Therefore, with precision "distortion free" lenses in the projectors of the new instrument, the new plotter would be suitable for use with aerial photography obtained with the new "distortion free" aerial cameras. However, consideration also had to be given to the use of existing aerial photography of larger radial distortion characteristics.

This high radial distortion requires some method of compensation so that the magnitude of the residual distortions does not exceed the requirements of "distortion free" photography. Mr. Theis, in his paper entitled "A discussion of the aerial camera-stereo instrument team"² establishes ten microns as the maximum radial distortion which can be accepted in "distortion free" photography.

A detailed study of the radial distortion characteristics of all precision aerial cameras with Metrogon lenses recorded at Army Map Service indicated that six different compensating systems were required to reduce the residual distortion of any one camera within the Metrogon system to ten microns or less. If a distortion compensating system were to be incorporated as an integral part of the stereo plotter projectors, it can be seen that twelve such compensating systems would be required for each two-projector plotter. If this requirement is multiplied by some forty odd instruments, it becomes readily apparent that such a system is neither economically nor mechanically feasible. However, the use of a universal-type printer, such as the Wild U-3 and the Zeiss Reductor, with a family of compensating plates for each particular system of distortion is capable of providing "distortion free" diapositives with ten microns or less residual distortion. As such printers with necessary compensating plates were available at Army Map Service for the production of "distortion free" diapositives, it was not necessary to provide for any distortion compensation in the stereoplotter.

As this tended towards simplified projector design, it was possible to incorporate into the performance specifications many of the desirable features of the multiplex, such as projector interchangeability, B_y and B_z translational movements, and low maintenance, without sacrificing the advantages of the 9 × 9-inch projection-type instrument. The intended permanent installation of the instruments precluded consideration of the weight of the instrument as a prime factor in its design; hence, it was possible to eliminate the reference or drawing surface as a source of error by using a commercial-grade surface plate for this purpose.

Preliminary specifications were discussed with five instrument manufacturers prior to the preparation of final performance specifications. In brief, the specifications require a dichromatic, optical projection-type instrument, suitable for use with vertical and 20° convergent, 9 × 9-inch distortion free diapositives, using a tracing table for vertical measurement. The projectors were to be

¹ The original text of this paper and those of the following five papers were submitted by the United States of America and appeared together as document E/CONF.36/L.47.

² *Photogrammetric Engineering*, v. XXIV, No. 4, September 1958.

without compensating devices and identical both optically and mechanically. The instrument, when used with vertical photography and three projectors, was to be capable of the simultaneous orientation and compilation of two adjacent stereo models. The projectors were to have a fixed principal distance of 153 millimetres and an optimum projection distance of 760 millimetres, and the lenses were to have a nominal focal length of 127 millimetres. The vertical accuracy of the instrument, when tested with vertical grid models formed at the optimum projection distance, was to be $h/10,000$. The design of the component parts of the instrument was generally left to the discretion of the instrument manufacturer.

The Army Map Service M-2 stereoplotter was designed and manufactured by the Belfort Instrument Company, formerly the Instruments Corporation, of Baltimore, Maryland. The plotter consists of a base frame, a reference surface or plotting table, an upper support frame, two or three interchangeable projectors, a tracing table, an electrical control box and a precision, variable-ratio pantograph.

The base frame is made of steel channels and plates welded into four units. These units are bolted together and support the reference surface and the upper support frame. The reference surface consists of a diabase (black granite) slab $64 \times 48 \times 4$ inches thick, flat to within five ten-thousandths of an inch over-all, and weighs approximately 1,700 pounds. The upper support frame is composed of two precision ground steel tubes sixty-eight inches long and four inches in diameter, held precisely parallel by a welded steel channel frame at each end. The tubes support the projector assembly and serve as the major X-axis of the instrument. The front tube also serves as an electrical conduit and contains three multipole receptacles which supply electrical current to the projectors and tracing table.

The projector frame rests on the upper support frame on six bearings and, when unlocked, moves freely along the major X-axis. The projector support arm, in the form of an inverted question mark, is attached to the projector frame and supports the projector assembly. A precision parallelogram is mounted on the tilt axis of the projector and correlates the movement of the tracing table and the attached light source, through extensible guide rods. The projector cone supports a removable diapositive plate holder. Each projector is provided with three rotational and three translational movements. Common tip and tilt are introduced by rotation of the upper support frame.

Vertical measurements of the stereo model are made by means of a tracing table similar in general design to those of other projection-type instruments. The counter of the tracing table may be read directly to two-hundredths of a millimetre and interpolated to the nearest one-hundredth of a millimetre. Two push buttons located in the base of the table control motor-driven rheostats in the control box, which in turn vary the light intensity of the projectors.

A precision pantograph of a cantilever, free-floating type is mounted on the base frame and provides reduction ratios from one-half to one-sixth of the model scale.

On testing the first M-2 stereoplotter, it was found that the new instrument was of higher precision than that specified.

In order to test all of the instruments for conformance to specifications and in order to determine accuracies attainable, stereo grid models were formed at a 0.65 base/height ratio, utilizing five-millimetre precision grids. The vertical displacements of the grid model from a true plane were measured at the conventional twenty-three grid intersections. Eighty-eight grid models were oriented and measured to determine the properties of the thirty-two instruments (six of which were of the three-projector type). The maximum deviation of any grid model from a true plane was found to be plus or minus eleven microns at plate scale and the maximum root mean square error was found to be plus or minus seven microns at plate scale or $h/21,700$. The average root mean square error for the eighty-eight models was found to be plus or minus five microns at plate scale or $h/30,400$. The minimum root mean square error of the eighty-eight models was found to be plus or minus two microns at plate scale or $h/63,333$.

Additional tests were performed with one instrument whose grid model accuracy was the maximum found in the series of instruments. These tests consisted of terrain model flatness and compilation tests. The terrain model flatness tests consisted of determining the instrument elevation of a number of points of known elevation from a stereo model, formed from vertical aerial photography taken at an altitude of 20,000 feet above mean terrain with a Wild RC7 aerial camera. The 100-millimetre focal length photograph was transformed to 153-millimetre focal length diapositives through the use of a Wild U3, Type A, Universal Printer. The stereo model was scaled to six horizontal control points and horizontalized to four vertical control points, one in each corner of the model. Three separate determinations of the instrument elevation of forty-seven check points of known elevation were made by each of three compilers. The root mean square error of the vertical elevations was computed and found to be plus or minus 2.57 feet or one part in 7,782.

The same model was compiled at a scale of 1:8,000 by the same three operators. The test compilations were reduced photographically to a scale of 1:25,000. The film positives of the test compilations were then compared to a base map of known accuracy of the area along five arbitrary profile lines, and the differences between the elevation of the contours of the base map and compilations were recorded. The C-factor of the instrument was then computed from this information. The C-factor of the M-2 stereoplotter so determined was 1,600.

In evaluating the various factors which have contributed to the high accuracy of the M-2 stereoplotter, the projection lens is a prime consideration. The vertical accuracy tolerances for the stereo grid model, as established in the performance specifications, required the lens manufacturer to reduce lens construction tolerances and to select only the very best lenses from a production run. Only 40 per cent of a normal production group of lenses was acceptable for this plotting instrument. An additional requirement for a calibration certificate for each lens, perhaps the first time such information has been required for a quantity of projection lenses for use in stereoplotters, provided a factual method of matching pairs and triplicates of lenses. This provided superior, well-matched lenses for use in the projectors which were entirely capable of producing stereo models of the highest accuracy.

Another factor contributing to the accuracy of the instrument is the removal of all moving parts from the optical system. This made possible the mounting of the projector lens in its proper optical position with very high precision and with the full assurance that this position would not be disturbed.

The third factor which has contributed to the accuracy of the plotter, and perhaps the most controversial, is the precision diabase (black granite) reference surface. The use of this material for the plotting table of a stereoplotter, although unusual because of its weight, offers many advantages. The flatness tolerances specified presented no manufacturing problems with this material, and the very nature of the black granite is such that there will be no changes in surface flatness caused by usage and age. The variation of this entire surface from a true plane is just slightly over ten microns, which, for all practical purposes, eliminates this as a source of instrument error.

For some time the Army Map Service has been con-

ducting comprehensive comparative evaluation studies of the accuracies obtainable with all types of photogrammetric instrumentation. As the tests of the M-2 stereoplotter were conducted with similar procedures and the same materials, comparative data on instrument capabilities were available. Therefore, it may be stated that, in terms of the vertical accuracy of the single model, the AMS M-2 stereoplotter is second to no other instrument of any type in use today.

In conclusion, it may be stated that the AMS M-2 stereoplotter is an economical photogrammetric plotting instrument of first-order accuracy and, when used as a companion compilation instrument with first-order universal instruments, permits the full exploitation of the inherent accuracies of these instruments. In addition, the accuracy of the M-2 plotter is such that it can be considered as a suitable compilation companion instrument for use with the new first-order universal photogrammetric instruments under development.

AUTOMATIC TYPE PLACEMENT SYSTEM

By Charles W. Schlager, United States Army Map Service

ABSTRACT

The present method of type placement requires that personnel seek out the location of features to be named in order that the proper size and style of type can be ordered. After the type has been received, the same area must again be found so that the type may be properly placed. A systems approach to "automatic type placement" is described which eliminates the latter operation. At the initial stage of ordering the type, the co-ordinate location for a particular name is recorded on paper tape. After receipt of the type image on film, the paper tape directs a co-ordinate positioning device to the previously recorded position and exposes the name to a large sheet of film. Other potentials of the system are described.

In the past few years advances in the fields of mapping and geodesy have been most rapid. Each year has seen progress in engraving processes, distortion free cameras, stereoplotting instruments; there have been impressive gains in image resolution, data handling equipment and electronic instruments in support of surveying problems.

To keep pace with the field, the Army Map Service is always interested in undertaking new development projects. An evident need for a more advanced means of placing map names presented itself. A study was begun to develop techniques and procedures for the use of a type placement machine known as the staphograph. The staphograph proved to be a desirable step forward in the placement of map names, and, within its inherent limitations, certainly proved its worth.

Because of the inherent limitations of the staphograph, it was deemed inadvisable to extend its capabilities to automation; therefore, we set about developing a means for accomplishing type placement through automation, using avenues of approach uninhibited by present concepts or methodology.

That you may appreciate the advantages of our proposed system for automatic type placement, I will describe briefly the operations which are currently involved in

conventional type placement and in type placement using the staphograph.

In conventional type placement the engraver uses the compilation names overlay in conjunction with the compilation manuscript. Using the compilation names copy as an identification guide for general placement, the engraver must determine the feature to be named and select the proper size and style of type for the feature. When this has been determined, the name is hand-lettered on a type request form and, subsequently, produced on celanese acetate film. Each word is then cut from this sheet of film and positioned on an overlay, using the compilation names overlay to show again the general location. When the feature has been located, the final position is determined and the type is burnished securely in place.

In the type placement steps used for the staphograph, the type is ordered in a manner similar to that of conventional type, i.e., general location shown by the compilation names overlay, size and style selected, type request prepared. Instead of celanese acetate film, a roll of 70-mm photographic film is produced by the photosetter.

Here, again, the exact location of each name *must* be sought; when determined, the exposure is made on a large sheet of film, which becomes the final names positive ready for reproduction.

In each of the foregoing methods two steps are required to determine the exact position for each name or number. The new proposal eliminates one of these operations and introduces other features which make the proposed system very desirable.

In our study three avenues of approach were considered:

(A) A system primarily mechanical and partly electrical;

(B) A system primarily electrical and partly mechanical, and

(C) A system almost solely electronic.

OBJECTIVES

PRODUCE POSITIONING
DATA & FILM REQUEST

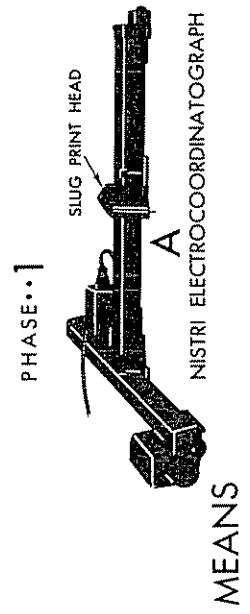

PRODUCE 70 MM
FILM OF TYPE

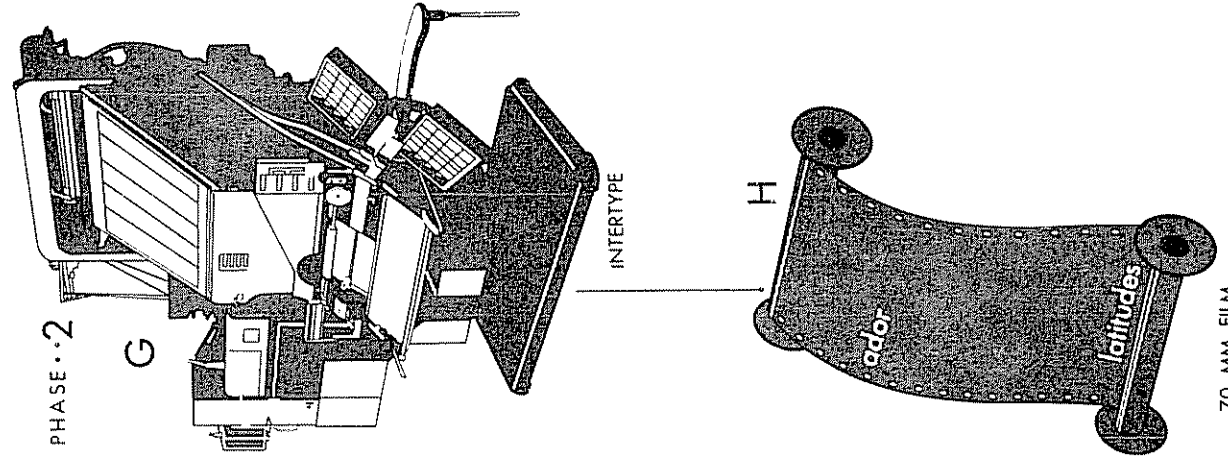

DEVELOP TYPE
POSITIVE

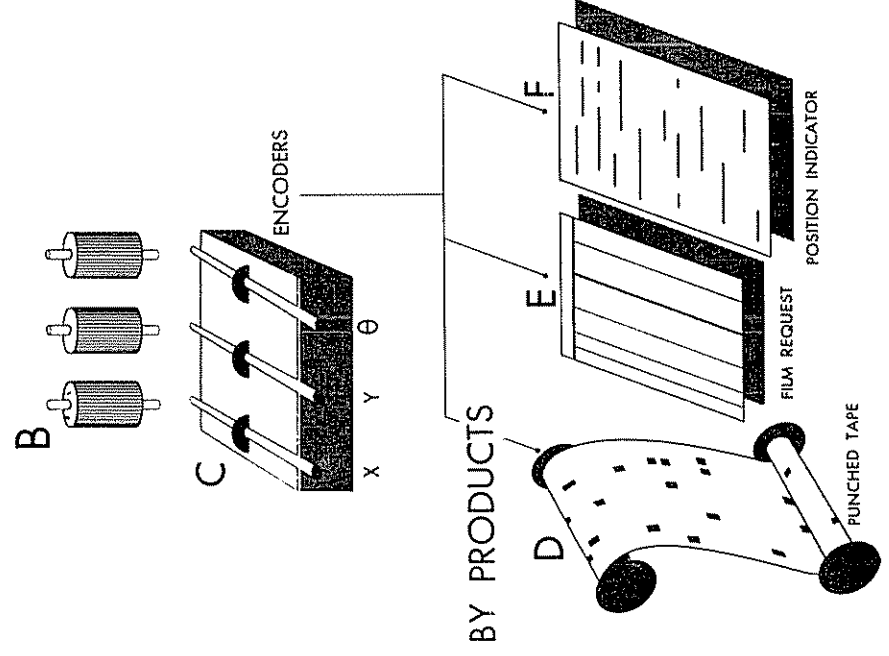
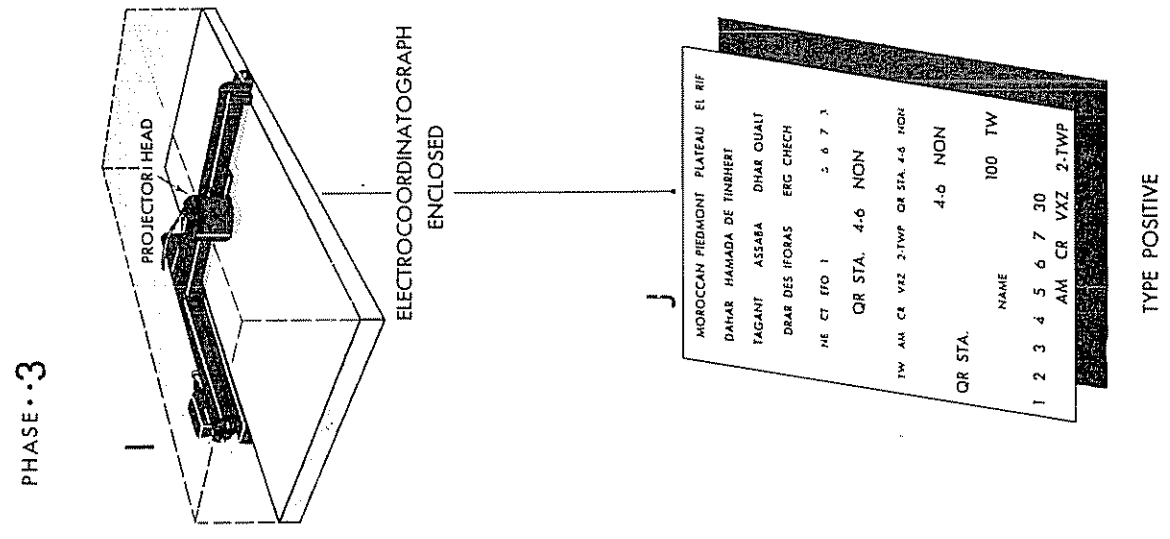

J

MOROCCAN PIEDMONT PATEAU EL RIF
DAHAR HAMADA DE TINBIHET
TAGANT ASSABA DHAR OUALI
DRAR DES IFORAS ERG CHECH
HE CT EFO 1 5 6 7 3
QR STA. 4-6 NON
TW AM CR VZ 2-TWP QR STA. 4-6 NON
QR STA. 4-6 NON
NAME 100 TW
1 2 3 4 5 6 7 30
AM CR VYZ 2-TWP

Figure 62. Proposed type placement system—Plan A

System A

The first system devised consisted of the items illustrated in figure 62. You will note that it is divided into areas—objective, means and by-product.

The objective of phase one is the production of the positioning data and the type order. A composite colour proof of the linear features of the map will be positioned under the electrocoordinatograph shown at "A". The arm of the coordinatograph will be located over the area to be named and placed in its final position by the use of a locating pin protruding from the print head unit. This pin will represent the extreme lower left-hand corner of each name.

If a name is positioned on an angle to the base line of the map, this print head unit will be provided with an angular motion rotating about the locating pin.

After the exact location of the name has been determined, the *X*, *Y* and angular information will be recorded by means of a sequential pulse code system on to tape. This tape will be used in later operations for locating the image placement. The number of letter spaces required for each name will be stamped on the colour proof or overlay. This will be accomplished by the print head unit, which will be made in such a manner as to provide blank slugs equal to the various sizes of letters. Thus, when a name requires a certain number of letter spaces of a given size, the print head will mark this area on the overlay.

When the location has been determined, the operator will hand letter on a type order form the name just positioned. These operations will be continued until all names to appear on the map have been given an *X*, *Y* and angular position. The by-products of phase one are:

1. Punched tape containing the co-ordinate positions;
2. The type order form or film request, and
3. The overprint guide or position indicator.

The objective of phase two is the production of 70-mm film containing the map names. By means of an Inter-type photo type-setting device, the typographer will produce 70-mm film, using the previously furnished type order.

The objective of phase three is the production of the final names positive ready for reproduction. This is accomplished by placing sensitized film under the electrocoordinatograph at "I".

The coordinatograph is provided with a projector head instead of the print head. The reel of 70-mm film is inserted in the projector head and activated in much the same manner as with the staphograph. The perforated tape will be read and the electrocoordinatograph will move to the *X* and *Y* position; at the same time the projector head will rotate to the correct angular position. Upon completion of these movements, indicated by a lack of current flow to the three motors, the exposure will take place. Following this exposure, the 70-mm film will advance to the next name, repeating the cycle until all names have been exposed.

System B

The second proposed system (see figure 63) resembles System A, except that a photo type-setting machine,

capable of operating from perforated tape, has been substituted for the manually-operated keyboard.

Because the Photon is capable of operating from perforated tape, a keyboard has been provided in phase one. After determination of the name location, the operator will type the name in its proper size and style on the keyboard, instead of hand lettering it as described in System A. This information will be recorded on the paper tape along with the *X*, *Y* and angular positioning data.

The tape will be used for two operations: first, it will be used to produce the 70-mm film automatically; and secondly, it will be used to drive the second electrocoordinatograph for final positioning and exposing of the map names, as explained in System A.

A third system was devised whereby the operations of producing the type, exposing and positioning were combined into one and the same operation. The electrocoordinatograph would be placed inside the Photon machine and moved over a large sheet of film. In this way the type could be exposed directly in position as it was being composed on the machine. This system was discarded in favour of a more versatile arrangement of machine components.

System C

System C (see figure 64) introduces an electron image tube similar to a television tube, but provided with a letter chart as shown. The operation of this tube simulates type setting in the steps of selecting letters, one by one, from a font of type and placing them on a line.

The font consists of a chart of characters on a lantern slide, which is projected on a photo-emissive cathode. Selections are made from the resulting electron-image stream and directed to the desired position on a phosphor screen of the tube. The resulting luminous images can then be projected on to photographic film as a means of preparing the names overlay.

The input control comes from a sequential pulse code, such as perforated paper tape, or directly from a keyboard.

The same positioning and input control is used as in System A. The tape is fed into the machine, and the required style of type is displayed on the face of the cathode ray tube. A set of lenses reduces or enlarges the type. The electrocoordinatograph, containing a plate holder on which the sensitized film is mounted, moves into the correct position. The angular positioning is accomplished by rotating the film plate, or by use of a prism. The exposure then is made directly on the sensitized film, becoming the names overlay.

The outstanding feature of this new device—as with all electronic devices—is high speed of operation. Letter display tubes of this type are being produced by Radio Corporation of America (RCA), Stromberg-Carlson and the Hughes Aircraft Company. Of particular interest is the feature which allows rapid change of letter style. The letter chart can be replaced readily and quickly by any one of a series kept in stock. RCA has a system in operation using this electron tube in combination with a projected form, which in turn is produced as a composite unit on 35-mm film. A high level of screen brightness is required for photographic recording at the speeds desired. In the RCA system ample light is available from

OBJECTIVES

PRODUCE POSITIONING
DATA & FILM REQUEST

PRODUCE 70 MM
FILM OF TYPE

DEVELOP TYPE
POSITIVE

PHASE •• 1

PHASE •• 2

PHASE •• 3

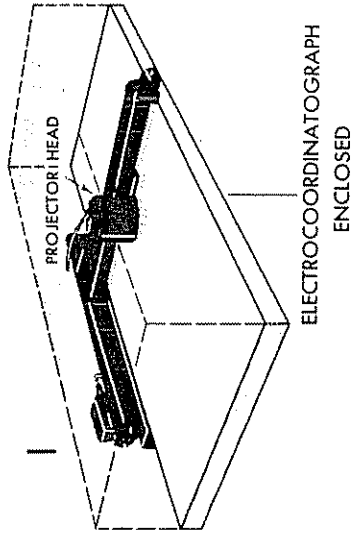
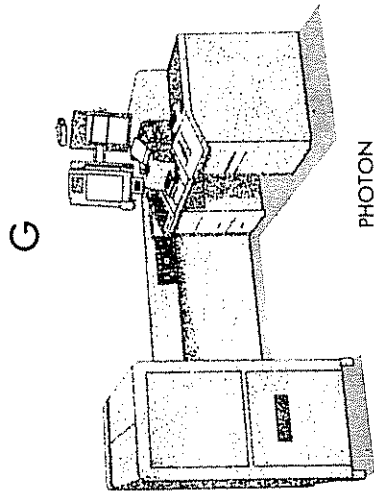
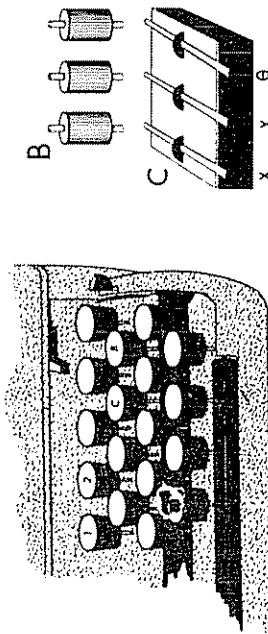
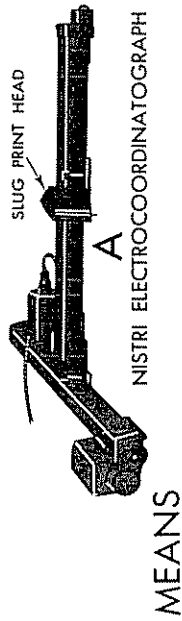

KEYBOARD AND RECORDING CIRCUITS

BY PRODUCTS

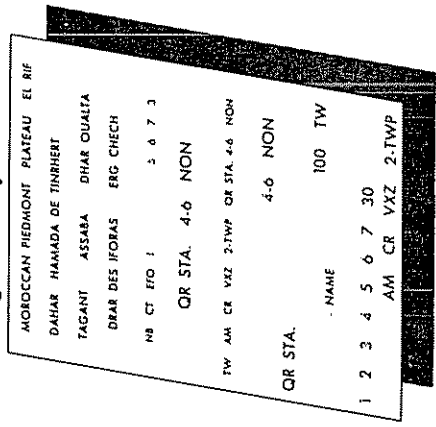
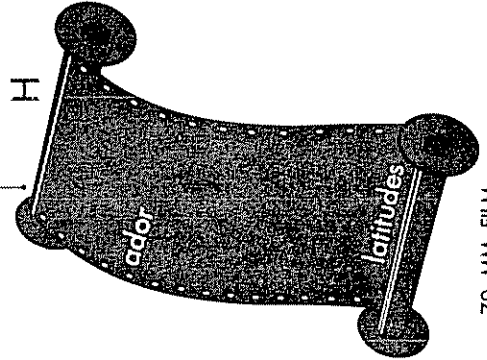
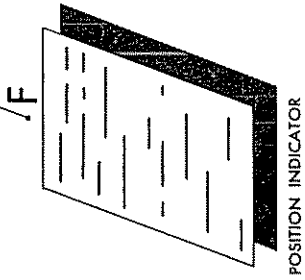
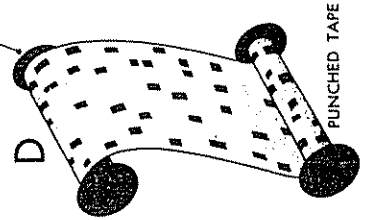

Figure 63. Proposed type placement system—Plan B

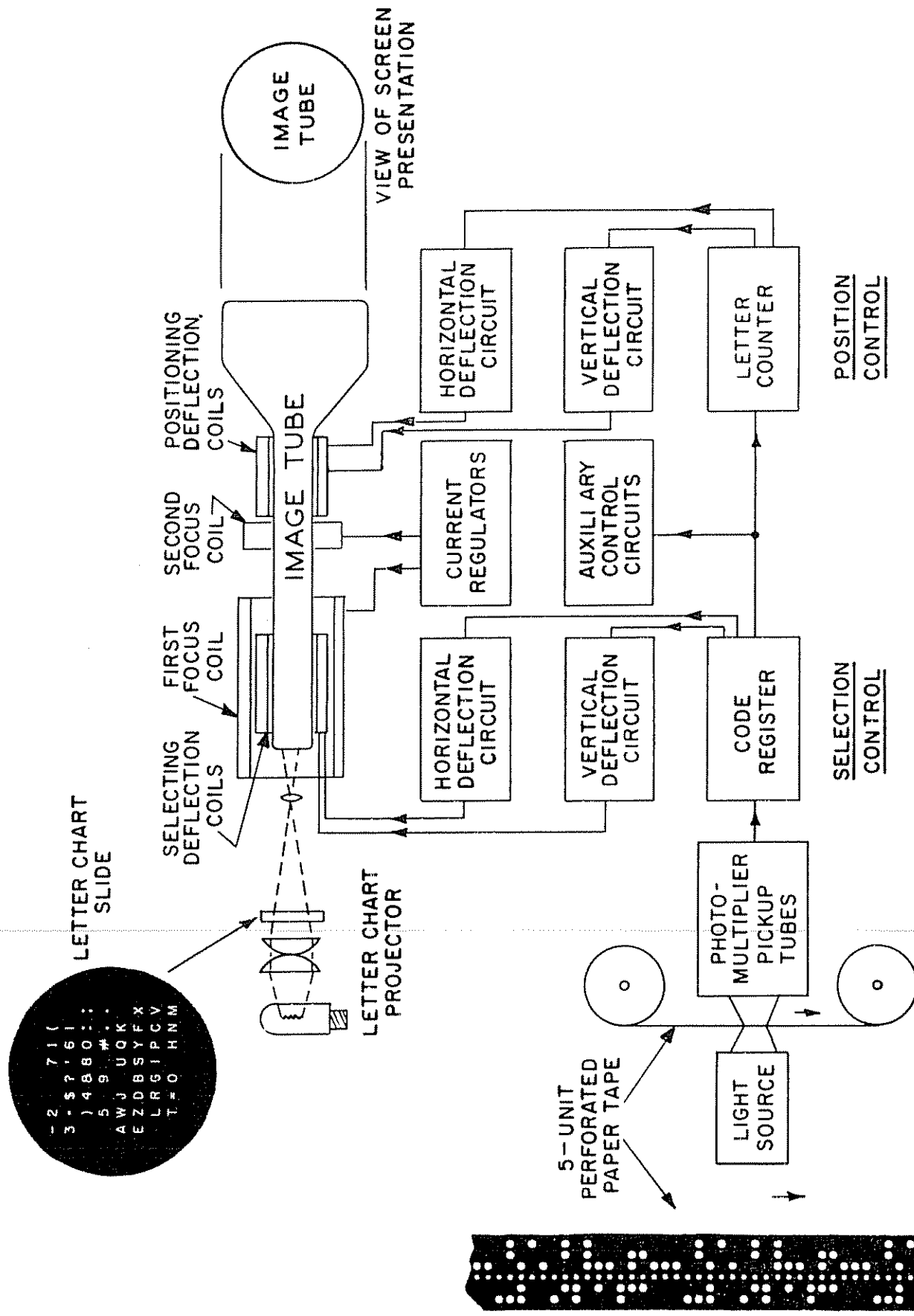

Figure 64. Experimental operating system for testing image selection and display tubes

the screen to expose 35-mm film at 6,000 characters per second. However, the present speed of exposure to 35-mm film is 4,000 characters per second. In the case of the Hughes Company tube, the rate of production is reported to be 25,000 characters per second. Although it is unlikely we would ever approach these speeds, these figures will give you a better insight as to the potentials of such a machine. Image quality (resolution) of these tubes is not satisfactory for mapping use at the present time.

Locating the feature which the type represents, determining the size and style of type to be used, determining the final position, and the typing or printing of the character information represent 80 per cent of the equipment utilization time. The remaining 20 per cent includes the composing of the type and the final positioning for exposure on the sensitized film, which is to be used as the final names positive.

If the system were built in one machine, it would require a highly-skilled operator capable of operating all phases. By using three units, each operation is somewhat simplified.

With all mechanical, electrical or electronic equipment maintenance is required. If the system were built in one machine, trouble in any one phase would halt the entire system until repaired. If built in three units, any trouble in one of the slave units would slow down production only a small amount. Trouble in the photo-composing unit would be a problem; however, the preparation of positioning and character information coding could still carry on while the photo-composing unit was being repaired. Due to the production speeds of the photo-composing unit, an operator would have very little trouble in catching up with any backlog built up during the disabled period.

Because the systems advanced here are revolutionary in concept, the advantages cited are those more obvious examples based on known related principles. The final system has the potentials of:

1. Eliminating the duplication of locating the feature to which the type pertains;
2. Eliminating the time required to cut out, position, align and burnish type matter;
3. Eliminating editorial review and correction for type alignment;
4. Eliminating the need for opaquing lines around type matter;
5. Eliminating most manual positioning of the final type image;
6. Saving time. (Even though slight additional time has been introduced at the outset of the positioning stages, it is estimated conservatively that the proposed system can save from 30 to 50 per cent of the time at present spent on type placement operations.)
7. If, over a period of time, specifications were changed so that a given style of type were used for all scales of maps, the basic film for a 1:250,000-scale map could be used to prepare names copies at various scales. It is conceivable that this information could be recorded on the perforated tape in such a manner as to make it readily accessible at will. In addition, it may be possible to utilize such data for the publication of gazetteers or, conversely, to utilize names information in gazetteer

form for partial production of names copies. Possibly this digital information for map names could become a part of, or be extracted from, the digital map library inherent in the Army Map Service Integrated Mapping System.

Upon completion of our study and an analysis of the various systems, a purchase description was prepared and submitted to industry. After an exhaustive evaluation of the proposals furnished by various manufacturers, a contract was awarded to Concord Controls, Inc., Boston, Massachusetts, with a completion date of July 1961.

Figure 65 shows a sketch of part of the automatic type placement system equipment as we envision it. Shown is a programming console where the names are given their co-ordinate location and where the overprint guide is marked. In front of the console is the electric typewriter which produces hard typewritten copy and a perforated tape containing the names, sizes and styles of the letters. The action of the operator typing the name causes a diaphragm to open on the viewing head of the programming console. This opening corresponds to the size of the name being programmed.

Also to be seen in figure 65 is the exposure unit where the products of the programming console and the photo-setter are used to prepare the composite names overlay.

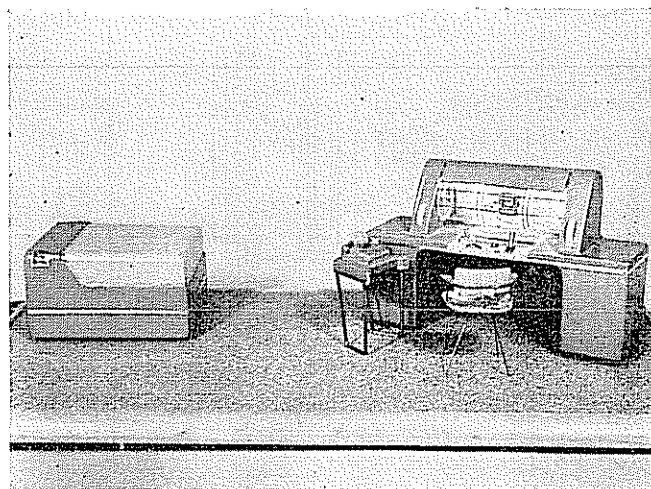

Figure 65. Automatic type placement system equipment

The operation of the system is essentially as outlined for System A except that provision has been made for the eventual production of the type-matter directly from the tape produced by the typewriter.

As previously stated, there are many advantages to such a system of placing names on a map. We firmly believe that the AMS automatic type placement system will fill a large gap in the area of semi-automatic and automatic mapping.

Note by the United States Army Map Service. Any mention herein of a commercial product does not constitute endorsement by the United States Government. Nothing herein is to be construed as necessarily coinciding with United States Army Doctrine. Changes in official doctrine, as they become necessary, will be officially published as such by the Department of the Army.

THE ELEVATION METER IN TOPOGRAPHIC MAPPING

Technical paper prepared by the United States Geological Survey

For several years, the United States Geological Survey has utilized the Johnson elevation meter for obtaining fourth-order vertical control for topographic mapping.

The elevation meter is an ingenious electro-mechanical device, mounted in a specially modified automobile (see figure 66). When driven along a road, it automatically measures the difference of elevation between selected points on the road. It consists essentially of two basic measuring elements: a very sensitive electronic pendulum to measure the instantaneous slope of each element of the road, and a special wheel to measure distance along the road. Through electronic circuitry, it continuously integrates the equation

$$dh = ds \sin\theta$$

where dh is an incremental difference in elevation in the distance ds , and θ is the angle of inclination of the road over the same distance.

To avoid the dynamic effects of acceleration and velocity on the pendulum, it is necessary to stop the vehicle to take a reading at each point where an elevation is desired. If no special precautions were taken, there would be a tendency for the instrument to read false slopes on curves, where the rear wheels normally describe a flatter curve than the front wheels. This is overcome by modifying the chassis so that the vehicle steers with all four wheels, and the rear wheels follow precisely in the same track as the front wheels.

In mapping operations, the fieldman first makes a thorough reconnaissance of the area. With the aid of the aerial photographs he locates all controlling bench-

marks, identifies them on the photographs, and transfers an elevation from each to a convenient point on the travelled roadway. He also selects and marks on the road and on the photographs other points at which supplemental elevations are desired. Then, with the elevation meter, he starts at a point adjacent to a bench-mark, drives along a planned route to a check bench-mark, and determines elevations of all pre-selected points along the way. Any closure error at the check bench-mark is prorated along the route. By properly planning his routes, he can cross previously run lines to obtain check elevations at the junction points and form a network of lines that can be adjusted by least squares methods.

Normally, the elevation meter is driven at speeds up to twenty miles per hour, depending on the condition of the roads, and production of from fifty to 100 miles per day is not uncommon. Accuracies within one or two feet can be obtained readily with proper controls on the planning and execution of the work. If desired, lines may be double run for greater accuracy.

Because the elevation meter is a relatively expensive piece of equipment and is capable of rapid production, it is used most efficiently on large projects with a fairly dense network of passable roads. It is not economical on small projects or where good roads are sparse.

The Johnson elevation meter is manufactured in the United States by the Sperry-Sun Well Surveying Company. The Geological Survey has recently acquired and is now using two units of a new model in which the electronic circuitry is completely transistorized to reduce power requirements and maintenance problems.



Figure 66. New model of the Johnson elevation meter

CONTRAST CONTROL FOR DIAPOSITIVES

Technical paper prepared by the United States Geological Survey

presented (1961) almost all topographic maps are prepared from aerial photographs through the use of stereoscopic plotting instruments. Most of these instruments utilize glass-plate diapositives prepared either at a reduced scale or at a reduced scale. To approach greatest plotting efficiency, it is desirable to transfer from the diapositive, as completely as possible, the imagery appearing on the original negative. To achieve such a transfer, some means of controlling contrast is necessary, particularly for aerial negatives having extremely large density ranges.

Objective of contrast control or dodging in diapositive preparation is to permit a transfer of photographic wherein the contrast between small contiguous areas is retained and, at the same time, the maximum minimum densities of the diapositives are limited. A limitation is that which can be accomplished in the viewing system of the stereoscopic plotter.

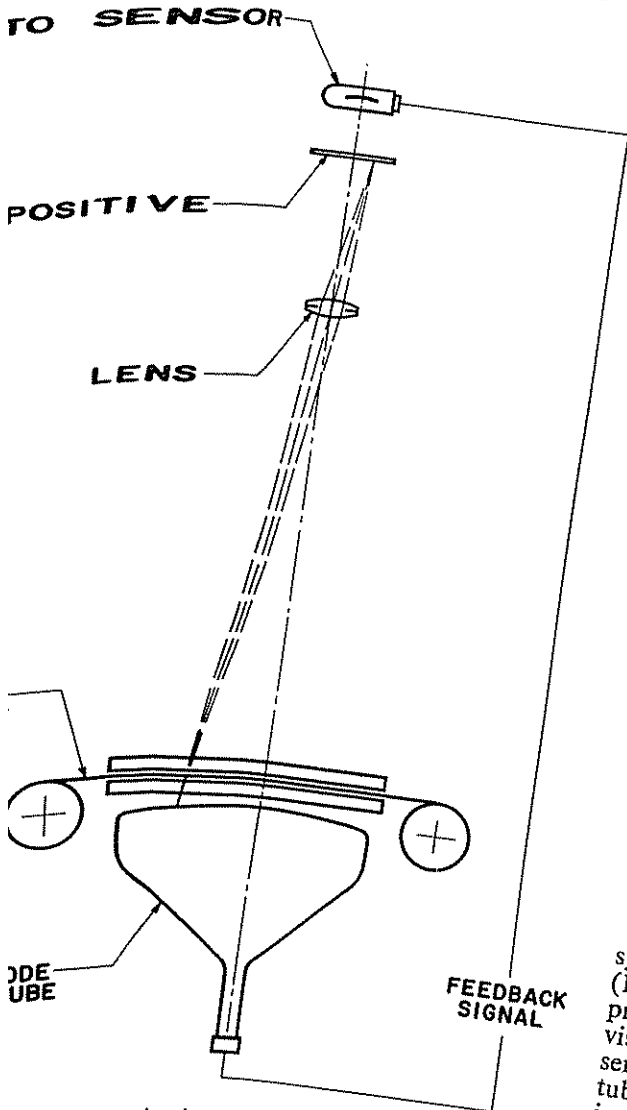

Figure 67. Schematic diagram of a 153/55 printer with electronic contrast control

When such "high-contrast" transfers are effected, the identification characteristics of images are retained and stereoscopic plotting efficiency increases.

All contrast control systems utilize light modulation. Those which may be used in diapositive printing, together with brief explanations of them are as follows:

1. *Hand dodging.* Exposure is varied between relatively large areas by a hand-held mask placed between the printing light and the diapositive emulsion being exposed. Although judgement is permitted, this is a laborious and time-consuming task. Small-area contrast control is not obtained.
2. *Unsharp-mask techniques.* Light modulation accomplished by placing a previously prepared unsharp positive of the exposure being printed between the printing light and the negative. In this process, light modulation is applied to somewhat smaller areas than in hand dodging. The system is time consuming because of the need for careful registry between the unsharp positive and the negative.
3. *Electronic feedback type.* Diagrammed schematically in figure 67 is a velocity modulation electronic

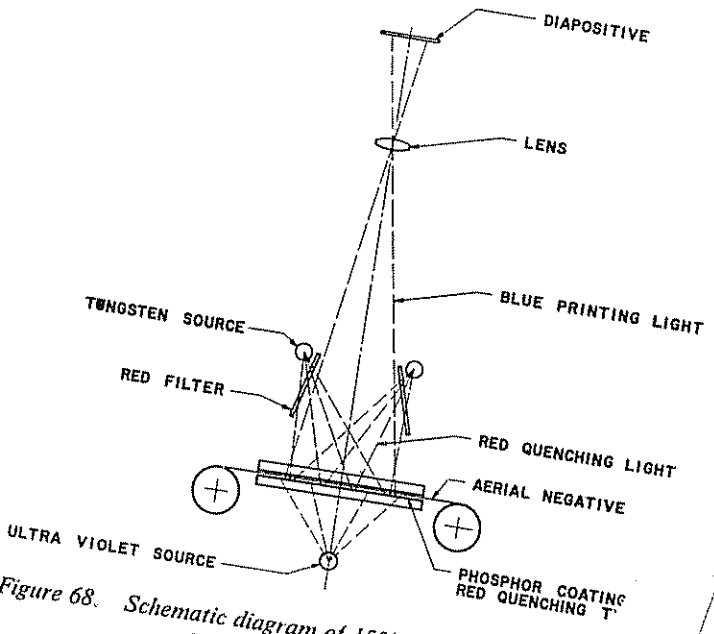

Figure 68. Schematic diagram of 153/55 printer with phosphor coating red quenching contrast control

system as installed in a 153/55 ratio diapositive (153/55 = ratio of camera focal length to principal distance). The scanning length of the vision tube provides the printing light. The sensor provides a feedback signal to the tube which causes a simultaneous and control in the speed of the moving spot on the face of the ray tube, in proportion to the density of the negative. Automatic exposure control is achieved in areas as small as the moving spot.

4. *Infra-red quenching type.* Figure 68 is a diagram of an infra-red quenching system installed in a 153/55 printer. An ultra-violet light source excites a fluorescent screen coated with an infra-red quenching-type phosphor. The screen emits blue light to which the diapositive emulsion is sensitive. The brightness of the screen is varied by the quenching action of the red light, the quenching being greatest in areas where the negative is most transparent. The screen thus emits a modulated blue

light just as if an unsharp mask had been inserted between the film and the screen. Figure 69 illustrates the benefit to be derived from dodging where the density range of the negative is extreme.

The trend in topographic mapping is generally towards more map detail and greater accuracy; automatic dodging is expected to contribute significantly to both these objectives.

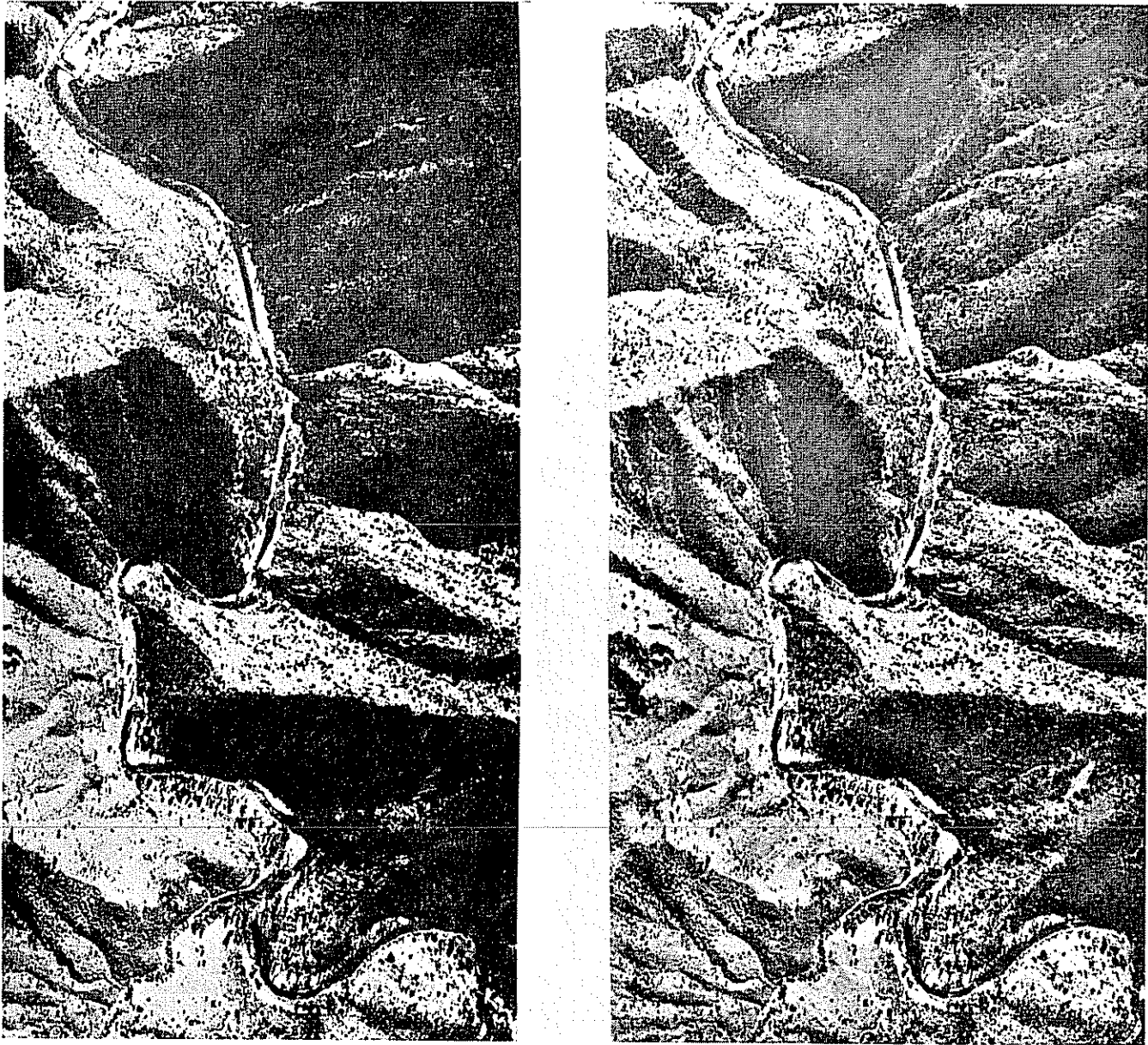

Figure 69. Comparison between undodged (left) and dodged (right) prints

NEW SALES EDITION OF TOPOGRAPHIC INSTRUCTIONS

Background paper prepared by the United States Geological Survey

The Topographic Instructions of the United States Geological Survey are being issued in a new series of publications. Prepared originally as operating instructions for the Topographic Division of the Survey, the publications will make available to engineers, scientists and the public, information on the standards, instruments and procedures employed in the preparation of quadrangle maps of the National Topographic Map Series.

The published Topographic Instructions ultimately will consist of about forty small volumes, each covering a separate phase of the operations. The set will constitute a comprehensive manual of topographic surveying and mapping. The three volumes now available from the Superintendent of Documents, United States Government Printing Office, Washington 25, D. C., are:

Multiplex Plotter Procedures. This volume covers in detail the principles of the instrument and the functions of the different parts. It gives step-by-step directions for routine calibration and adjustment, orientation, stereotriangulation and other operating procedures in plotting topographic quadrangle maps with this type of photogrammetric survey instrument. These instructions incorporate the latest improvements in multiplex techniques used in the Survey. The forty-five-page volume contains twenty-one illustrations and sells for 45 cents.

Kelsh Plotter Procedures. This volume describes the Kelsh plotter, one of several types of map plotting instruments used by the Survey in the photogrammetric survey phase of preparing quadrangle maps. These instructions explain the principles on which the instrument is based, the operation of the optical and mechanical parts, the methods of calibration and adjustment and the procedures for interior, relative and absolute orientation of stereoscopic models. The twenty-nine-page volume contains thirteen illustrations and sells for 35 cents.

Planimetric Map Compilation with Trimetrogon Photographs. This volume gives instructions for preparing small-scale maps and charts from trimetrogon aerial

photographs. It explains the procedure for compiling planimetric detail upon a previously prepared radial-triangulation base by both sketchmaster and the stereoblique systems. A chart of planimetric compilation symbols is included. This twenty-eight-page volume contains eleven illustrations and sells for 30 cents.

Other Topographic Instructions volumes in preparation are listed below:

The National Topographic Map Series	Training Manual in Photogrammetry
Triangulation Fieldwork	Stereophotogrammetric Compilation
Triangulation Computations	ER-55 Plotter Procedures
Transit Traverse Fieldwork	Universal Plotter Procedures
Transit Traverse Computations	Twinplex Plotter Procedures
Geodetic Leveling	Orthophotoscope Procedures
Control Surveys with Electronic Instruments	Analytical Aerotriangulation
Supplemental Control Surveys	Planetable Operation
Supplemental Control by Photogrammetric Methods	Field Mapping and Completion Surveys
Supplemental Control by Altimetry	Accuracy-Testing Surveys
Supplemental Control by Elevation Meter	Map Revision
Processing Control-Survey Data	Topographic Map Symbols
Standards for Treatment of Map Features	Topographic Map Lettering
Aerial Photography for Mapping	Color-Separation Scribing
Photogrammetric Photolaboratory Operations	Map Editing and Checking
Photogrammetric Rectification	Special Maps and Cartographic Processes
Base Sheets for Stereocompilation	Tables for Computing Geographic Positions
Aerotriangulation with Templates	Cartographic Tables
	The Public-Land Survey System
	Definitions of Topographic Surveying and Mapping Terms

When these volumes are published, they will be announced in the monthly list "New Publications of the Geological Survey" (available free on request from the US Geological Survey, Washington 25, D. C.) and in Price List 53, "Maps, Engineering, Surveying" (available free on request from the Superintendent of Documents, Washington 25, D. C.).

SINGLE-PRISM STEREOSCOPE

Technical paper prepared by the United States Geological Survey

The single-prism stereoscope is a compact viewing instrument designed specifically for field use. Many geologists and others who annotate photographs under field conditions prefer this type of stereoscope. The unique viewing system of the instrument facilitates delineating on the photographs.

The original design of this type of stereoscope does not incorporate optical magnification. The optical system consists only of a small double-reflecting wide-angle prism that bends the line of sight 60°. One of the photographs of the stereoscopic pair is viewed monocularly through this prism. This photograph is mounted on a holder that forms a 60° angle with the plane of the holder supporting the other photograph. The second photograph

is viewed simultaneously and directly by the other eye. This optical arrangement eliminates the need for the photographs of the stereopair to overlap physically.

Because magnification is desirable for many operations, lenses of about 1.5× power were introduced in a later design of the instrument. A viewing magnification of 2.0 is considered the practical limit for this type of stereoscope.

The holders for the photographs are hinged together and fold like the covers of a book; they may be opened or closed in a single motion without disturbing the relationship between the photographs. The optical system is fastened to the hinge between the holders. When opened, the stereoscope and the previously aligned photo-

graphs are ready for immediate use. The prism unit can be moved along a line perpendicular to the flight direction of the photographs and tilted about this same

view the right-hand photograph of a stereopair, directly or through a magnifying lens. All delineations and notations can then be readily made on that photograph. The stereoscope is, however, easily adapted for convenient use by left-handed observers.

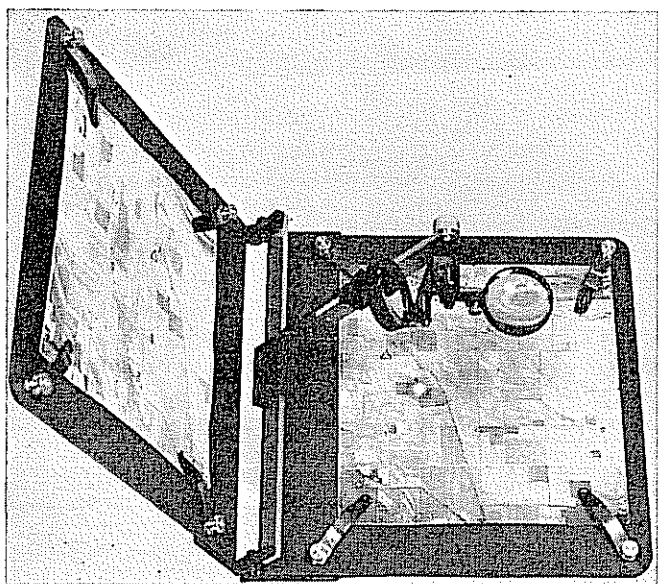

Figure 70. Single-prism stereoscope with magnifying lens

line. These provisions permit the observer to view any portion of the stereoscopic coverage of the two photographs, quickly and conveniently.

To avoid undue eyestrain, the angular relationship between the photographs and the prism must be maintained within one degree. Adjustment is not difficult. Right-handed observers generally use their right eye to



Figure 71. Field use of stereoscope

REPORT ON SCRIBING¹

Technical paper by the United States Geological Survey

Introduction

The maps and charts produced by the United States Government usually require large numbers of copies, the editions ranging from a few hundred to many thousands. The methods employed for making copies have, therefore, always been important. Recently a procedure called "negative scribing" has come into increasing use, and seems likely to replace the present methods employed in photolithography and engraving. Negative scribing offers economy in production operations, without sacri-

fice of quality. It is also faster to train operators to do scribing than to train draftsmen and engravers.

In 1954, the Bureau of the Budget, in order to facilitate the development of negative scribing, formed a committee of representatives of the federal agencies that are large producers of maps and charts to study and report upon this new technique.

Part I of this report describes the procedures, methods and instruments used in negative scribing. Part II is a description of scribing in the Geological Survey and part III a glossary of technical terms. A bibliography on scribing is appended.

¹ The original text of this paper, submitted by the United States of America, appeared as document E/CONF 36/L 48.

I. Scribing applied to modern cartography

GENERAL DESCRIPTION

Scribing

Scribing has been defined as the act of marking material with a pointed instrument. As practised in the graphic arts field, scribing is akin to engraving. It is an efficient delineation technique that, for the sake of simple explanation, may be said to be the converse of conventional drafting in the production of line drawings. In drafting, pencil or ink markings are applied to the base sheet; in scribing, material is removed where markings are desired.

Negative scribing

In negative scribing, a transparent image is delineated through an actinically opaque material. The scribing medium is a sheet of clear glass or plastic to which a scribe coating has been applied. Working over a light-table, using special tools called gravers, the operator cuts out image lines or symbols to produce a transparent-image, opaque-background effect similar to that of a photo negative. Light passes through the scribed image lines but is held back by the uncut portions of the coating; thus the scribed negative may be utilized in the same manner as a photo negative in subsequent reproduction processes.

Choice of base material

Scribed negatives prepared on thin, flexible material may be contact printed from either side, the same as thin-base photographic films. This important attribute allows a choice of normal or reversed images to suit the requirements of associated processes. The use of glass or a thick plastic base does not allow such choice because the excessive space between image and photosensitive surface in back-to-face printing causes refraction and diffusion of the exposing light rays, producing a blurred print.

Application

The scribing technique can be substituted for drafting in almost any application, and is being adopted by most federal mapping agencies to replace earlier engraving and drafting techniques. In map and chart preparation it is used for compiling manuscripts with stereoplotters and for field sketching by plane table, as well as in the map finishing phases. The most common application is the preparation of colour separations for multicolour printing by photolithographic methods. The multicolour process requires the use of a separate press plate for each class of map features that is to be printed in a separate colour. The scribed negatives constitute the final hand-rendering of map detail, and the press plates may be prepared from them by direct photomechanical transfer.

Scribing has proved to be a convenient and productive means of delineating map copy and is the choice of many cartographers today for that reason alone. However, the greatest potential benefit lies in its compatibility with other procedures and processes of modern cartographic production and reproduction. A full appreciation of the impact of scribing on the entire mapping cycle can best be obtained by a study of part II of this report.

ORIGIN AND DEVELOPMENT

Origin

Scribing as a method of marking or delineating has come down through the ages since man first marked lines by a finger or stick in the very sands of time.

Scribing as a negative medium or stencil dates back to the early use of waxy or resinous resistant coatings through which designs were scraped or cut to admit chemical or abrasive action to etch the portions of the coated object thus exposed. Indeed, the caveman may have scribed marks or crude drawings through sooty or mossy wall coverings so that they became etched or stained by the elements through time for prehistoric record.

Early development

From such beginnings, naturally and gradually evolved the manual engraving techniques of printing and the graphic arts, including wood, stone and copper-engraving procedures, which were to have their span as recognized map delineation and reproduction methods. From these manual engraving methods, in step with the development of photography and industrial chemistry, followed the photomechanical processes of photoengraving and photolithography. These, too, became recognized reproduction processes, especially photolithography, which was particularly well adapted to making the large photo negatives required in map reproduction from the master ink-drafted map drawings carefully prepared for camera copy.

Negative engraving

Imperfect negatives required repair, and the intricate detail of map negatives often required correction. More than twenty years ago certain individuals familiar with making hand corrections to negatives by engraving, long a standard procedure in wetplate photolithography, pointed out the advantages of extending negative engraving techniques to the production of entire negatives by hand engraving. The smooth-drafted drawing step would be eliminated as the unrefined original map manuscript would serve as the camera copy to produce the delineation guide copy, and the refinement would be inherent in the engraving delineation later.

Wetplate negatives being very adaptable to fine line engraving, considerable success was achieved in this direction in several exemplary cases. During this time existing engraving tools from other fields of engraving were adapted—awkwardly in many cases—to the job of delineation engraving through the asphaltic coatings and wetplate collodion photo-image on its plate of glass, which was the media of that period.

Despite this success, scribing as a direct outgrowth of wetplate negative engraving did not become popular, partly because of a natural resistance to change in established routines, partly because some considered glass too fragile and, in map sizes, inconveniently heavy and hazardous, and partly for the significant reason that many agencies were not equipped with facilities for making wetplate collodion negatives.

An economic influence further hampered the adoption of scribing as a popular technique at that time. The unemployment situation created an abundance of trained

draftsmen from industry for absorption by the then greatly expanded cartographic programmes which already had exhausted the meagre supply of available map engravers.

Transition

Thin photographic film had been gradually and then more rapidly replacing glass for negatives in the commercial shops. While such film was not yet dimensionally stable enough for precise cartographic scale requirements, it was gaining considerable favour in the less scale-critical areas because of its adaptability to photomechanical processing techniques. Its manoeuvrability, resulting from the flexible thinness, allows direct contact pressures without hazard of breakage, and also makes possible both direct or reversed contact photoprinting to effect negatives and positives in normal or reversed image positions as desired, quickly and economically.

It was natural at such a time, with expanded programmes and an abundant drafting force, to take every advantage of the adaptability of drafting techniques to the use of thin film and its adaptability to photolithographic techniques, in those instances where critical scale factor did not require the precise dimensional stability of glass negatives and a more stable base. In fact, it accelerated the search for films of greater dimensional stability.

Thus, while it can truly be said that modern scribing today, as a delineation technique, comes to us by way of glass negative engraving, the acceptance of scribing as a fully functional component of modern cartographic operational procedure was influenced to a considerable degree by the adaptability of thin films to photomechanical processes, and the ease with which trained map delineation draftsmen could be converted to, or beginners trained in, the scribing technique. The advent of improved dimensionally stable film suitable for cartographic scale requirements was the turning point in successfully developing modern scribing and its popular adoption in cartographic operations today.

Development to modern scribing

Three major contributions are significant milestones in the development of negative scribing into the modern technique now so widely recognized as an efficient and manoeuvrable component of modern cartography and its complexity of process and procedure in production and reproduction.

Tools

Instruments were deliberately designed for the specific purpose of glass negative engraving. These basic tools were adaptable for scribing on glass or plastics. Points and blades were precisely ground to cut cleanly through the scribe coatings yet glide smoothly over the surface of the supporting base materials without digging in.

Improvements have been made which relieve the operator from much critical attention in co-ordination of eye, mind and hand to operate the tool itself, allowing greater concentration on the objective job of productive delineation. New tools have been added and ingenious auxiliary devices developed further to supplement achievement. Descriptions and illustrations of tools and instruments appear elsewhere in this report (see the section on "Instruments" below).

Improved coatings

Vigorous research in new coatings to replace the collodion and asphaltum combinations kept pace with

new materials and requirements. Each new plastic sheeting or new solvent presented new ideas and problems. From this came several improved coatings and the knowledge and experience necessary to design coatings for special purposes and to control them for adequate performance. Coatings of different colour—yellow, red, green; coatings applied differently—flowed, sprayed, rolled, whirled; coatings of varying texture or characteristics—hard, soft, thin, thick, opaque, translucent, were developed, any of which may best serve a particular purpose. Today, a variety of satisfactory scribe-coated sheets are available from commercial sources. Some of these materials are supplied in pre-sensitized form, although most agencies prefer to exercise a choice of sensitizers for individual application in their own plants to suit the various copy processing requirements. Coatings are described in detail in the section entitled "Scribe coatings" below.

New plastics

At about the time of the Second World War, industrial chemistry produced thin plastic sheetings of greater dimensional stability than previous films commonly used as the base to support emulsion coatings for photography. These thin, scale-stable sheets in almost any sheet form—polished or matte surface, transparent or opaque, photosensitized or plain—had a long-awaited and natural place in modern cartography. The new materials were immediately put to use in the drafting rooms, in the photo-processing laboratories, and as practical substitutes for glass in scribing operations. (See "Base materials" below.)

With improved coatings applied to the new plastic sheetings, the scribing process at last had available a thin, flexible and sufficiently scale-stable scribing medium.

ADVANTAGES OVER ALTERNATIVE METHODS

In the cartographic industry, as in others, with modern mass production methods being geared to an increasing volume and variety of specialized products, the seemingly incompatible goals are improved quality and larger output at lower cost. To attain these goals, an adequately trained technical staff must be maintained and operations must be streamlined and yet made more flexible. Scribing fits well into the map production cycle and has contributed greatly to the efficient execution of expanded mapping programmes. Scribing on coated plastics is superior to pen-and-ink drafting, copperplate engraving and other traditional methods in the following principal respects.

Training

The initial training period for new employees is shorter. Because scribing is performed with precisely-ground engraving points held in fixed relationship to the work surface, the former need for sensitive instrument control to produce accurate line widths has been greatly lessened. The highly developed "draftsman's touch" and the delicate craftsmanship of the copper engraver are no longer required; much of the trainee's effort can now be directed towards learning to delineate accurately and acquiring the over-all map knowledge so essential to the well-rounded cartographic technician.

Production

The production rate of trained employees is considerably higher and is increasing as instruments and techniques are improved. Scribing is more receptive to

mechanization than other methods. For example, the use of templets permits the scribing of many outline-type symbols which were formerly printed on adhesive-backed material and applied to the colour separation drawings. This contributes not only to speed and accuracy, but also to the permanency of the symbols. In pen-and-ink drafting it is difficult to keep the sheet background clean and to achieve and maintain adequate density of the inked lines. Normal handling often weakens the contrast below minimum reproduction needs. A greater proportion of the operator's time may now be devoted to accurate delineation, rather than to the maintenance of line quality. Uninterrupted production is more readily sustained because there is no need for the scribe to stop for "inking-up" and pen wiping operations or to allow inked areas to dry.

Quality

Despite increased production rates, the quality of the finished product is improved to a surprising degree. Line widths are more accurately controlled by precisely-sharpened needles or blades, rather than by pressure on pen points, precise ink consistencies and the texture of drafting surfaces. In addition, the editor's inspection for quality, uniformity and width of line work is facilitated, and more of his attention may be concentrated on accuracy of map content. The nature of scribed lines is such that their precision may be verified with a minimum of review. The quality inherent in negative scribing is retained through the plate making stage, thereby permitting finer lines and thus further contributing to the neat appearance of published maps.

Adaptability

Scribed negatives, if at publication scale, make possible simple phototransfer procedures whereby the lithographic plates are processed directly from the scribed work. This eliminates most of the camera work formerly involved and lessens the deterioration of line quality. Despite this streamlining of techniques, the negative-scribing method permits, and in fact invites, more flexibility in procedures as the need arises. Prime examples of this are (1) the recent development of a means of dyeing the lines on scribed Vinylite negatives and removing the coating to produce transmuted positives, (2) the introduction of transparent coatings to permit the trace-scribing of detail underlying the coated sheet, (3) a method of solvent-etching types and symbols into the scribe coating through a light-hardened stencil emulsion and (4) the use of coated plastic sheets as compilation bases, after which the compiled detail is scribed directly thereon to form reproduction negatives. Many other deviations and improvements of this nature are possible with the new scribing medium.

Revision

Scribed plastic negatives, unlike photographic film negatives, lend themselves to revision of base information, as is periodically required in most mapping and charting programmes. This precludes the need for reverting to inked drawings and reprocessing negative copy to effect changes in map data.

Handling and storage

The beneficial aspects of scribing are not limited to production operations alone. The handling of scribed map components is more convenient than that of metal-mounted drafting boards or glass negatives. Storage and shipping problems are minimized because of less volume

and weight, and copy is more durable and resistant to damage.

From the foregoing comparisons it will be seen that scribing represents one of the greatest advances in the cartographic field of the past decade. It has enabled the industry to keep pace with the growing cartographic needs of the armed forces and the civilian economy. Virtually at every turn and at every stage of operations we reap benefits from the adoption of scribing, and ultimately, better maps are delivered to the user in far less time. Also, whereas drafting was a long-established and largely developed technique, plastic scribing is conducive to further research and innovation. Scribed negatives possess almost unlimited potential for process design to suit the many complex and involved situations or specified requirements in modern cartographic operations. There is little doubt that the break-away from the ruling pen and quill is merely the trigger mechanism of a vigorous developmental advance just getting under way.

BASE MATERIALS

The function of the base material is to receive and support the coating in such a manner that accurate and efficient scribing and reproduction of map detail is readily achieved. The material must be both optically and actinically transparent, allowing the passage of light through the scribed lines to accommodate photomechanical and photographic reproduction processes. It must have a smooth, polished surface sufficiently hard to resist penetration and marring by scribing tools under normal pressures, and must possess a high degree of dimensional stability under commonly encountered variations in temperature and humidity. The material must also be light and flexible, yet sufficiently tough and durable to withstand the effects of handling, storage and shipping.

No material now utilized is ideal in all respects, but an adequate combination of desirable qualities is found in glass and the two plastics, polyethylene terephthalate (brand "Mylar D") and vinyl chloride acetate (brand "Vinylite"). Each of these materials has distinctive qualities which offer advantages under certain conditions and disadvantages under others. A choice of which to use should be based not only on the scribing operation itself, but also on the requirements of associated production operations. The following analysis of the relative merits of glass, Vinylite and Mylar with respect to the most important characteristics is presented as a guide for the prospective user in the selection of a base material.

Scribing quality

The ideal situation dictates that once the scribing point has penetrated the coating and is in contact with the base material, it should glide easily over the surface under normal pressure without digging in or scoring it in any way. Whether or not it will do this is dependent on the surface finish and the hardness of the base material assuming the point to be correctly ground. In these respects the superiority of glass is unquestioned. In so far as the plastics are concerned, Vinylite, as compared with Mylar, can accommodate a greater range of instrument pressure. Its surface seems to yield slightly to the scribing point before breaking under excessive pressure, whereas Mylar appears to have a less plastic surface and a somewhat stratified interior structure which allows the point to break through and jam more readily. This demands a greater sensitivity of touch on the operator's part when

working on Mylar; however, the necessary delicacy can be acquired.

Dimensional stability

With regard to stability, glass is again clearly superior. Among the plastics, Vinylite and Mylar have proved to be adequately stable under controlled temperature and humidity conditions. Mylar is considerably more stable under extremes of temperature, therefore particularly well suited to certain field operations. On the other hand, Vinylite is somewhat more resistant to the effects of humidity and consequently has the advantage where temperature is constant and extremes of humidity exist. Thus, it is clear that the conditions under which the material is to be used and stored are strong factors governing the selection of a plastic base.

Durability

An obvious objection to the use of glass is its susceptibility to breakage in handling. Vinylite is better in this respect, but Mylar is far superior in shatter resistance and general strength. Mylar is also unaffected by many chemical reagents and solvents and is therefore more durable from this standpoint. Such chemical resistance or inertness, although furnishing notable advantages, is sometimes detrimental to cartographic operations, inasmuch as it hampers the use of certain desirable techniques involving the application of dye, ink or solvents to the base material. Some of these techniques were developed especially for Vinylite and have not as yet been successfully adapted to Mylar.

Thickness

Glass plates, being much thicker and heavier than plastic sheets, are at a serious disadvantage from the standpoints of handling, processing and storing. Type D Mylar, the type most suitable for cartographic use, is available in thicknesses of 0.003", 0.005", 0.0075" and 0.010". The 0.0075" material is recommended for most colour separation scribing. Vinylite is produced in sheet thicknesses ranging from 0.005" to 0.125", in increments of 0.005", with 0.010" and 0.015" being most extensively used as a scribing base. Vinylite at this thickness provides sufficient rigidity to minimize the effects of particles or imperfections on the table top beneath the sheet, and thereby promotes uninterrupted ease and smoothness of scribing. Mylar in the recommended thickness is more susceptible to the effects of irregularities in the supporting surface. Both direct and reversed contact photo-printing are possible with minimum line distortion when the thinner Mylar sheets are used. Its thinness is also a distinct advantage in any operation wherein two or more sheets are superimposed to verify the register of map detail.

Sufficiently important to warrant reiteration is the fact that the selection of an effective base material is not dependent on scribing qualities alone—the environment and the entire chart production procedure must be taken into consideration. Due to the marked differences between the various media with respect to thermal and hygroscopic coefficients of expansion, it is inadvisable to intermingle dissimilar base materials in multiple-sheet production arrangements. The two plastics described and recommended herein by no means represent the ultimate in such media, and any choice between them is essentially a compromise. Nevertheless, in the light of a most satisfying trend among interested federal and

private organizations toward closer co-ordination of effort and better understanding of common objectives, it is entirely possible that near-perfect new media will be forthcoming.

SCRIBE COATINGS

The most critical single requirement for successful scribing is a good coating. From the very beginning this has been a problem, and much research effort has been expended in the attempt to develop a coating which satisfies the following essentially conflicting requirements. (1) It must be sufficiently transparent to allow copy placed under it to be observed and traced, or sufficiently translucent to allow guide copy printed on the surface to be similarly followed when lighted from beneath; yet it must be opaque to those wavelengths of light which affect photo-sensitive emulsions. (2) It must adhere tightly to the base material so as to permit the scribing of fine and intricate detail, yet be easily and cleanly removable with properly sharpened graver points. (3) It must be sufficiently non-abrasive to cause minimum wear of the scribing point, soft enough to permit easy movement of the tool, and yet hard enough to resist accidental mutilation during the necessary production handling. (4) It should be receptive to water-base sensitizers such as "Watercote" and "Colorline", yet be suitable for photo-mechanical etching with solvents that are safe to use in confined spaces. For some uses it should also have a good drafting surface for pencil and ink.

From the above requirements it is readily seen that the production of good scribe coatings has been no easy task. Early coating of glass plates was done in photographic laboratories by the whirling method, using a commercially available pigmented solution known by the trade name "Flo-Paque". This same coating was later applied to the plastics and is still being used. Several commercial firms have entered the coating field, and a variety of formulations applied by roller coating, spraying, whirling or screen coating are now available. Roller coating would seem to be the method best adapted to the mass production of coated plastics. Although a few agencies still prefer to coat their own sheets, the trend is toward the use of pre-coated products now on the market.

Research in coating materials and methods is continuing. Recent developments indicate that dyed coatings may eventually supplant pigmented coatings, because they are more transparent, less abrasive, and equally satisfactory in most other respects. Newly developed orange-tinted coatings which seem very promising permit the photoprinting of either film positives or press plates, yet have sufficient visual transparency to allow the tracing of map detail without the use of a light-table. The colours of some coated sheets can also be modified by immersion in dye solutions, either before or after scribing. Two disadvantages encountered in some dyed coatings are the lack of visual contrast between the coating and scribed detail, and the fact that coating residue left in the lines is difficult to detect.

INSTRUMENTS

Scribing instruments, of which there is a large variety, may be divided into three general classes: (1) gravers, consisting of a carriage or handling structure of some kind, having provision for holding a scribing point in a controlled position; (2) mechanical guides, such as templates, straightedges and curves, used to guide the points, and (3) sharpening devices, or jigs, which are used to

hold the points for precise grinding to correct sizes and shapes.

Present-day gravers are, in most instances, modifications of instruments originally designed for engraving on glass. These instruments are designed to hold the scribing points at certain angles to the surface. There is considerable variation in detail among the various agencies. Typical instruments in general use (see figure 72) are:

A. *The rigid graver.* As its name implies, this instrument has no moving parts, and the scribing point is held in a rigid position. The latter consists of a round needle with a flat-tipped conical point held vertically so that a line of the same width is cut no matter in what direction the graver is moved. The body of the instrument consists of a small table, or carriage, usually supported at two places by ball-bearing-tipped legs and at a third place by the tip of the point itself. There is usually a vertical fin or vane on the top of the carriage to provide a convenient grip; however, a variety of carriage shapes and supports may be encountered. The rigid graver may be used freehand or in conjunction with straightedges, templates or other guides. Conical points wider than 0.015" are difficult to use because they do not penetrate the coating readily. Wedge-type points are sometimes used to scribe wide straight lines.

B. *The swivel graver.* This is a variation of the rigid graver, and the carriage has the same general shape and parts. However, the scribing point is held in an offset, freely turning arm which swivels to follow any direction in which the carriage is moved, so that the scribing edge remains always at the same angle to the direction of the line being scribed. The swivel graver is used to cut parallel lines, analogous to lines drawn by the conventional double-line swivel drafting pen, or very wide single lines. For scribing double lines two needles or a slotted blade are used.

C. *The pen-type graver.* This graver consists of a needle in a pen-staff style of holder, and is intended primarily for freehand scribing, although it may also be used in conjunction with a templet or other guide. Because the point is not fixed at a constant angle to the surface, it is provided with a round point so as to operate uniformly at a variety of angles without scratching the base material. Phonograph needles are commonly used, sometimes with specially hardened tips. The pen-type graver is not suitable for scribing lines wider than 0.004".

D. *The building graver.* This is a specialized instrument used to scribe the solid rectangles or squares which traditionally symbolize buildings, hence the name for this graver. The body of the graver rests directly upon the scribing surface. From it protrudes an arm on the end of which the wedge-type scribing point is fastened. The arm is held by springs in a raised position. The width of the cut is governed by the size of the blade used, and the length by a setscrew which adjusts the horizontal stroke. Scribing is accomplished by pressing downward until the point penetrates the scribe coating, then pulling backward until the full length of cut has been made. Upon release of pressure, the arm automatically returns to its original position. Variations in design exist, and building gravers are sometimes mounted in special bases to facilitate building alignment and spacing and to permit the scribing of dashed lines.

E. *The dot graver.* This instrument, which may be either manually or electrically operated, consists of a structure containing a vertical shaft on the lower end of which is a chuck to hold the scribing point. The manually-operated dotter has a shaft assembly similar in principle to a push drill—a downward stroke causes the shaft and point to rotate. The rotating point of the electric dotter is brought into contact with the work surface by pressing a finger button. Both instruments have built-in springs which lift the point from the work surface when finger pressure is released. For dots up to 0.008" in diameter a flat-tipped triangular point gives satisfactory results. For larger dots a ninety-degree wedge-shaped blade is more effective.

F. *Graver points.* Points are of two principal shapes: (1) the blade type, having a wedge- or chisel-shaped edge, and (2) the round needle type having a cone-shaped tip with the point ground flat. A variation of the latter is a round-tipped needle used with pen-type holders and normally confined to the scribing of very fine lines. Scribing points must be carefully ground to the required line widths and the most effective cutting angles. Jigs for sharpening angled points have been developed by several agencies. Illustrated are a few of the many types of needles and blades in common use. They include steel phonograph needles, specially constructed needles and flat steel blades, some tipped with jewels and hard alloys. Some agencies favour the relatively inexpensive and easily sharpened steel points; others prefer the more permanent and more costly jewel-tipped points which are usually pre-sharpened in manufacture. In general, needles are preferred for single lines and blades for double lines, although there are some notable exceptions.

GUIDE IMAGE

Image source

The accurate and selective scribing required for each colour separation is usually performed with the aid of a guide image processed on the scribe coating. The exact procedure for obtaining a manuscript copy suitable for processing the guide image is dependent on the nature of the original manuscript. The master compilation is usually photographed to obtain a negative at colour separation scale, although the preparation of scribed compilations at reproduction scale is gaining favour in many agencies. In any case, if the scribed colour separations are to be used for direct exposure of the press plates, the processed guide image should be left-reading (mirror image) so that it will be a normal left-reading negative when scribed. The press plates, when processed, will then be normal right-reading positives suitable for offset printing.

Processing the image

A variety of photo-transfer processes may be used for preparing the guide image. One of the simplest, requiring a minimum of equipment, employs a commercial sensitizer called "Watercote" which is available in several colours. The sensitizer is applied to the coated sheet by flowing, swabbing, rubbing or whirling, whichever is most convenient. After it dries, the prepared sheet is placed in contact with the manuscript negative in a vacuum frame and exposed to intense light. The exposed sheet is flushed with ammoniated water, rinsed in clear water, and, if required, swabbed lightly with cotton until the image is

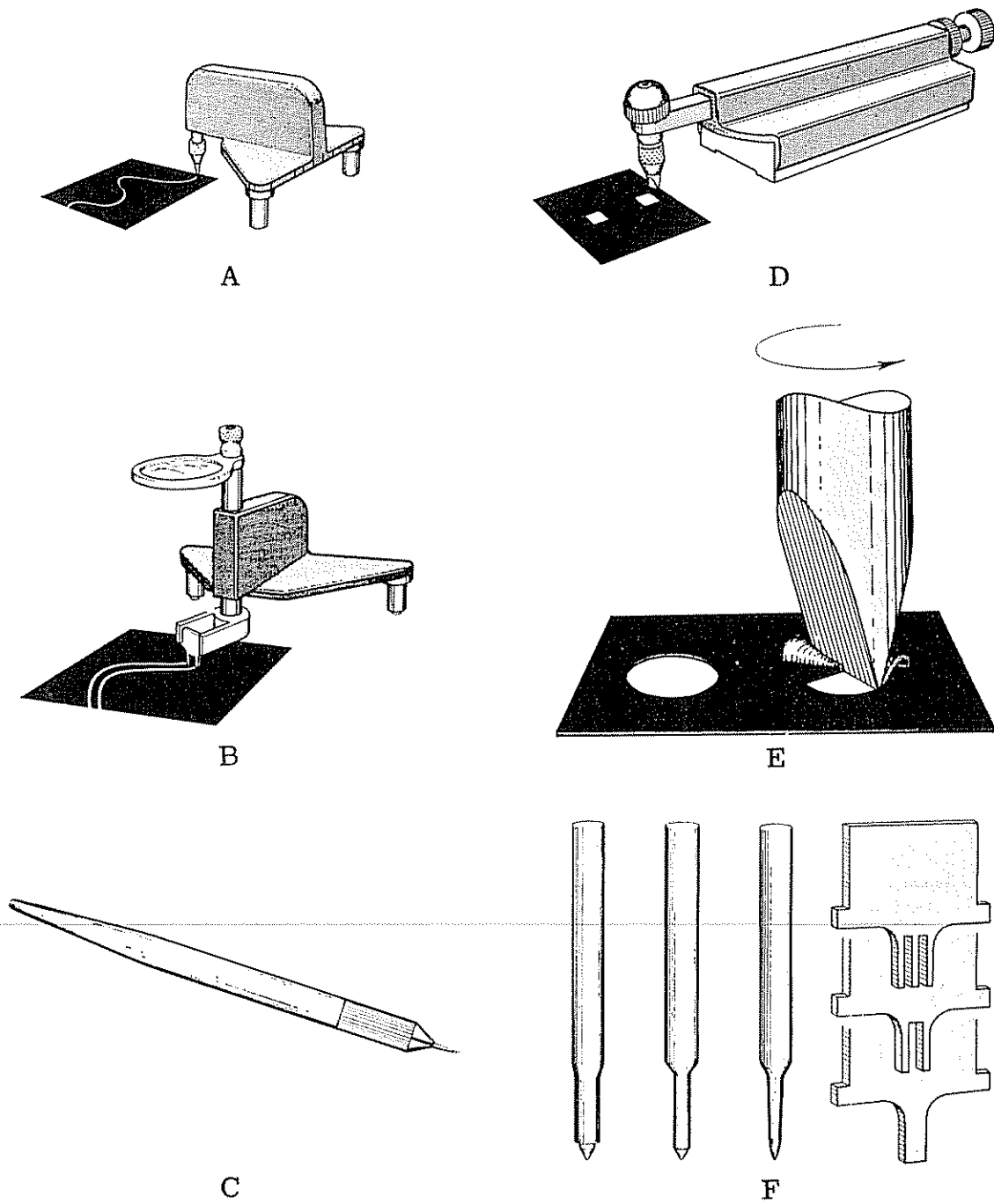

Figure 72. Scribing instruments

(A) the rigid graver; (B) the swivel graver; (C) the pen-type graver; (D) the building graver; (E) the dot graver, and (F) graver points

sufficiently defined, then removed from the water and air-dried. The sheet is now ready for scribing.

A sheet is prepared in the above manner for each separation required. These individual guide copies are commonly referred to by the colour of the features that are to be reproduced therefrom, i.e., "black copy" or "black guide", "blue copy", etc., or by the class of features, such as "culture copy" or "culture guide" and "drainage copy". A selection may be made to reserve the more legible images for the more intricate scribing.

Some agencies compile maps by separating detail, such as planimetry on one sheet and topographic relief on another. Where this method has been employed, or where detail is recorded on a separate sheet to supplement the basic compilation, it may be advantageous to process the guide image in separate colours. The different colours of the composite copy aid the scriber in interpreting the copy. The multicolour image is produced by successive exposure and development, using a different colour of Watercote sensitizer in processing each component.

COLOUR SEPARATION SCRIBING

The objective in colour separation scribing is that of producing finished negatives suitable for use in preparing lithographic press plates. To accomplish this, all required imagery must be scribed cleanly so as to remove the coating completely and leave the base material unmarred. The work is usually done on an under-lighted table with sufficient room illumination to allow easy reading of the image and proper operation of the gravers. The use of a blue filter is helpful in determining whether or not the line work is absolutely clear. Scribing techniques will vary slightly with individual operators but in general gravers are designed and sharpened to do a specific job and will be used in like manner by different operators. Corrections may be made by painting out the incorrect areas or lines with an opaquing fluid and scribing the corrections after the fluid has thoroughly dried. The instruments and techniques used in scribing the various categories of map detail are as follows.

Lines

Lines 0.004" or less in width are usually scribed with the pen-type graver. This graver may be used for free-hand work or in conjunction with a straightedge, curve or any specially designed templet. The rigid graver may also be employed in any of the above applications at the option of the operator. Line widths up to 0.015" may be scribed with the rigid graver using the normal conical point. This graver may also be used freehand or in conjunction with a straightedge, curve or templet. If line widths greater than 0.015" are desired, a chisel-shaped point will operate more easily. Double lines, such as road symbols, are scribed using the swivel graver fitted with a double-line blade or two properly sharpened needles. Special blades may also be obtained for scribing single- or multiple-line symbols. This graver is used freehand or with a straightedge or curve. Dashed lines are usually scribed as continuous lines, then broken by opaquing. Dots or dotted lines are best made with the dot graver, which is equipped with a rotating point. For best results it is essential that all graver points be properly sharpened in order to ensure a clean, smooth line suitable for making high-quality press plates. Sharpening techniques will vary depending on the base material used and the quality of the coating.

Symbols and letters

Map and chart symbols are scribed with the aid of templets, using either the pen-type or rigid graver. Satisfactory templets have been made from plastics or thin metal. Where a variety of standard symbols is involved it has been found practical to have templets produced in quantity by precise punch-and-die methods. Some of the more complex symbols are not readily adaptable to templet scribing and therefore other means must be resorted to in order properly to portray the symbols.

(a) Symbols and letters in positive stickup form may be affixed to a transparent overlay properly positioned with respect to the map image. A negative of this overlay is made for processing the appropriate printing plate, or the overlay may be processed directly to the scribe-coated sheet by photomechanical etching;

(b) The scribed negative may be used to obtain a contact positive for the application of additional symbols and lettering. A negative must be prepared from this positive for processing to the appropriate press plate;

(c) Stripping film with a negative image of symbols or letters may be applied directly to the scribed sheet after removing the scribe coating in the areas where the symbols and letters are to be inserted.

Further elaboration on these or other methods may be found in part II of the present paper.

Area symbolization

The portrayal of area features, such as woodlands, swamps and bodies of water, requires that the areas be prepared in such a manner that solid tints or appropriate patterns may be printed. The relative extent of the areas involved determines whether they are prepared in positive or negative form.

Solid tints. Areas to be printed in solid tint are usually prepared by one of the following methods:

(a) By removing the scribe coating from the plastic base by first scribing the outlines, then scraping the coating from within the scribed lines; or by painting the areas with a water-base, solvent-resistant material and washing away the unprotected portions with solvent;

(b) By opaquing the selected areas on a transparent overlay;

(c) By peeling a special film from its plastic base after the area outlines have been scribed, cut or etched. On certain materials the stripped areas may be dyed to fix the image permanently.

Patterns. Areas requiring patterns may be prepared as for solid tints. If only one type of pattern is to be shown, the open areas may be processed to the press plate through an interposing screen containing the pattern. If several patterns are to appear simultaneously, they may be stripped on the appropriate areas. If suitable scribe coatings are used, patterns may also be photomechanically processed and etched. In certain instances, for practical reasons, the patterns are sometimes scribed manually.

FLOW DIAGRAM

The flow diagram in figure 73 illustrates a generalized scribing and reproduction procedure. In practice, none of the agencies follows the exact procedure shown. Maps and charts are produced by the various agencies to widely

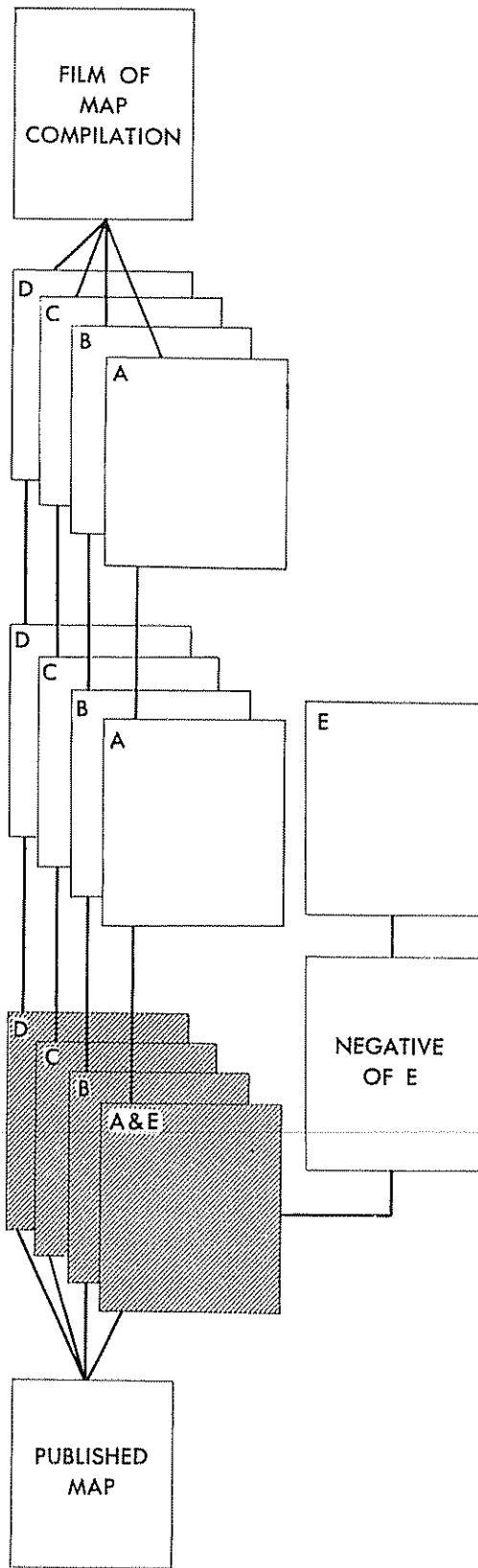

LEGEND

<i>Map Feature</i>	<i>Published Color</i>
A Culture.....	black
B Hypsography.....	brown
C Hydrography.....	blue
D Road classification.....	red
E Lettering.....	black

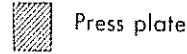

Guide image

The film of the map compilation is used to process its image in left-reading position on scribe-coated sheets; one for each color that is to appear on the published map.

Scribing

Following the guide image, the delineator scribes the detail required for each color, producing a series of negatives. Lettering printed on adhesive-backed, transparent film is applied to an uncoated base sheet. A negative of this overlay is then made for further processing. Individual or composite proofs may be made as required for checking, editing, or other purposes.

Press plates

The scribed negatives and the lettering negative are contact printed to the offset press plates, producing right-reading printing images. The culture features and lettering are combined on a single press plate.

Published map

The multicolor map is printed from the several color-separated press plates.

Figure 73. Generalized flow diagram for colour separation scribing

different specifications. Such demands do not permit complete standardization of methods. Operations are influenced by such factors as source material, compilation and revision methods, special requirements and desired end-product. The general trend, however, is towards

complete utilization of scribing techniques throughout the production cycle. Part II of this report contains detailed information on colour separation processes and also indicates the extent to which scribing is being applied to other phases of map and chart production.

II. Scribing in the Geological survey

MATERIAL AND EQUIPMENT

Base materials

Early scribing in the Geological Survey was done on glass, Homalite plastic and vinyl plastic. Use of these materials was eventually discontinued in favour of type D Mylar for all scribing applications. Generally preferred is 750-gauge (0.0075-inch) Mylar, although thinner gauges are sometimes used in special procedures which require the printing of scribed images through the base material. Mylar was chosen over vinyl materials because of its greater strength and resistance to thermal distortion; it is suitable for use in the field as well as in the office. In addition, although scribing pressures and point sharpening tolerances are somewhat more critical, properly scribed lines are slightly cleaner on Mylar.

Scribe coatings

The Survey obtains most of its scribe-coated sheets from commercial sources. Both yellow and rust pigmented coatings are supplied, and they are equally satisfactory from the opacity standpoint. Yellow is preferred by some offices because it provides greater contrast with the guide image.

Some coating is done in the Geological Survey to fill emergency needs or to provide material suitable for special processes. The preparation used is yellow Flo-Paque diluted with Varsol to 16° Baume. Dark castor oil is added to this mixture in the proportion of five ounces to the gallon. The liquid is mixed thoroughly in a paint shaker and strained through eight layers of cheesecloth. The Mylar sheets are taped in a whirler and cleaned with a household detergent, then wiped with alcohol-saturated cheesecloth and dried with clean cheesecloth.

The whirler is set at 50 rpm, and pouring is started in the centre and moved slowly outwards until the entire surface is covered. To prevent the formation of bubbles on the surface, the pouring pot has a spout at the bottom. Unless the whirler is large enough to accommodate four sheets at a time, an adjustable platform is used to permit the sheet to be offset several times during the whirling; otherwise the coating would be noticeably thicker in the centre. Whirling is continued until the paint has set, after which the sheets are placed in a ventilated rack to dry.

Instruments

The principal scribing instruments used by the Survey are illustrated in figure 74. Several other scribing instruments and associated aids are illustrated in figure 75. In addition, drafting machines, parallel ruling devices, various types of spading tools and other miscellaneous scribing aids are sometimes used.

Most graver points (figure 75) are inexpensive steel phonograph needles or flat steel blades. They are carefully ground to cut specified line weights. A rake angle

of 45 degrees (*see* figure 76 d) is ground on points that are to be used on Mylar bases. A device incorporating the necessary stones for sharpening the swivel, building and rigid graver points with the proper angles is shown in figures 76, 77 and 78. Most phonograph needles have rounded tips which scribe lines of approximately 0.002-inch width without grinding. Osmium-tipped needles are often used for these fine lines because of their greater durability. Because the fineline (pen-type) graver does not hold the needle at a constant angle to the scribing surface, the tip must be rounded; therefore, the unsharpened needle is used in this instrument. The unsharpened needle is also used in the rigid graver for scribing lines 0.002-inch in width.

GUIDE IMAGES

Image sources

Most Geological Survey topographic maps are regular quadrangles of either the 7.½-minute or the fifteen-minute series. Normally they are compiled by photogrammetric methods and completed by means of field surveys. While the scribing technique was being adopted in stereocompilation and field mapping, the sources of guide images for colour separation scribing were many and varied. During this transition period, copy preparation methods were often combinations of the processes detailed here and those formerly employed in preparing drafting guides. Now that scribing is firmly established in all mapping phases, image sources for colour separation scribing have become more standardized.

For quadrangle maps of the 7.½-minute series, the sources are at publication scale (1:24,000) and usually consist of: (a) two stereocompiled quadrangle-size scribed manuscripts—one containing the planimetry, the other the relief features, and (b) two or four scribed field manuscripts (halves or quarters) containing additions to and deletions from both planimetry and hypsography. In low relief areas, the contours are plotted by plane table survey. In these instances they appear on the field manuscripts along with the other completion data, and there is only one stereomanuscript—that containing the planimetry. In some offices the woodland outlines are compiled on a separate sheet instead of being included with the other planimetric features.

For quadrangle maps of the fifteen-minute series, published at 1:62,500 scale, the image sources are at 1:24,000 scale and usually consist of eight scribed manuscripts—one of planimetry and one of relief for each of the four 7.½-minute quadrangles that make up the fifteen-minute quadrangle. Unlike those destined for publication in 7.½-minute format, these manuscripts are complete in that they contain both stereo compiled and field surveyed information, the field corrections having been transferred photographically to the stereomanuscripts and scribed or opaqued as required.

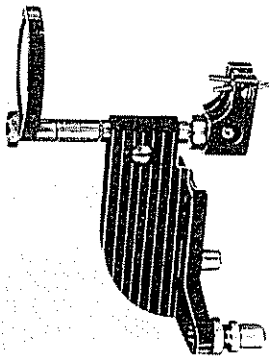

Swivel Graver

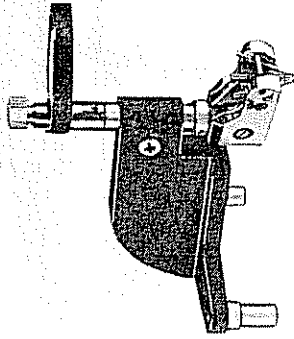

Swivel Graver (dual lane roads)

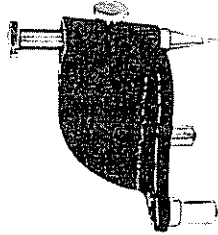

Rigid Graver

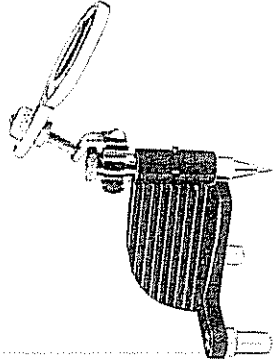

Rigid Graver with Magnifier

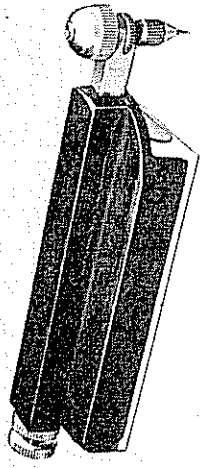

Building Graver

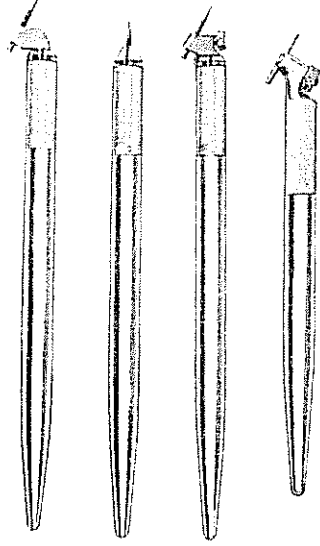

Fineline Gravers

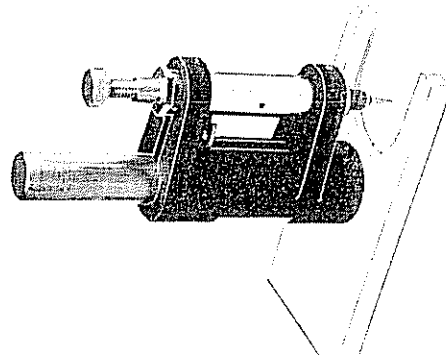

Mechanical Dot Gravers

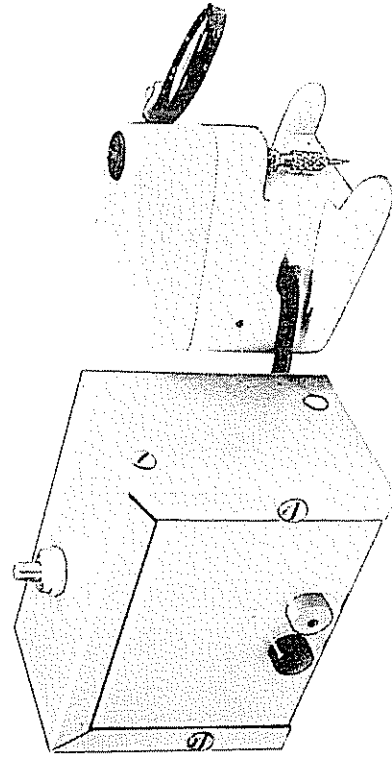

Electric Dot Graver with Power Pack

Figure 74. Examples of scribing gravers used by the United States Geological Survey

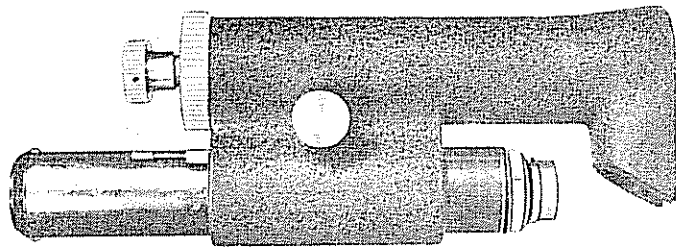

Shear Microscope

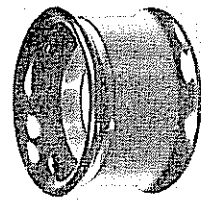

Hand Magnifier



Ball-bearing Swivel Knife

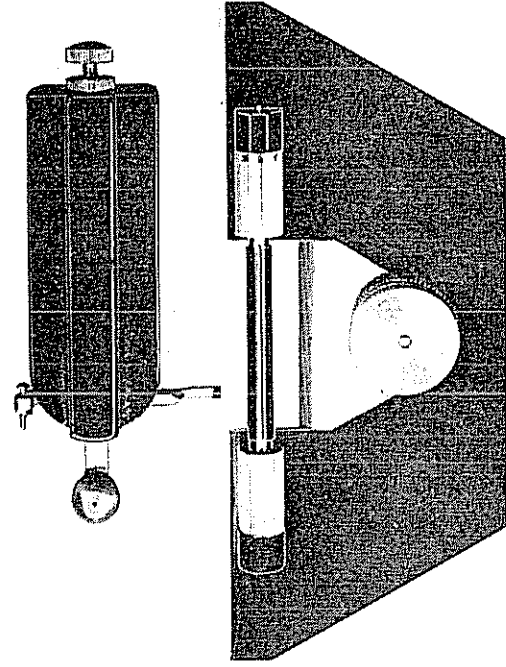

Building Graver Guide with Mediated Building Graver

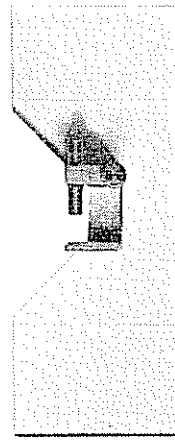

Rigid-Graver Building Guide

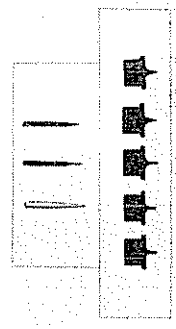

Graver Points

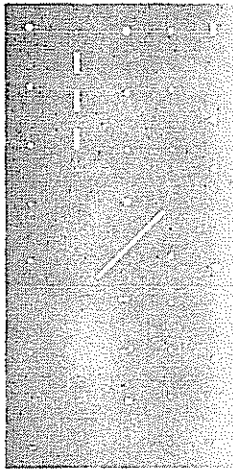

Plastic Template

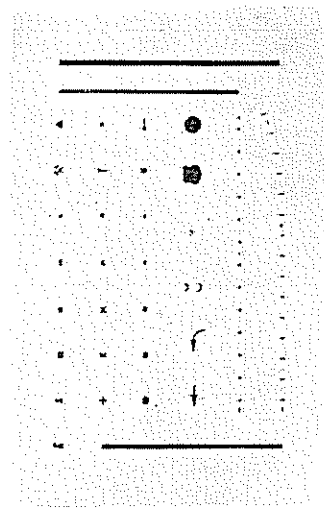

Glass Template

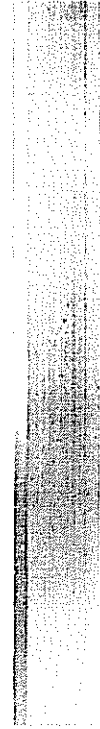

Straightedge

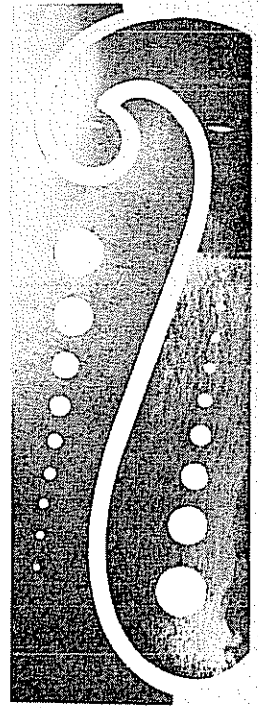

Metal Combination Straightedge-Curves

Figure 75. Examples of other scribing instruments used by the United States Geological Survey

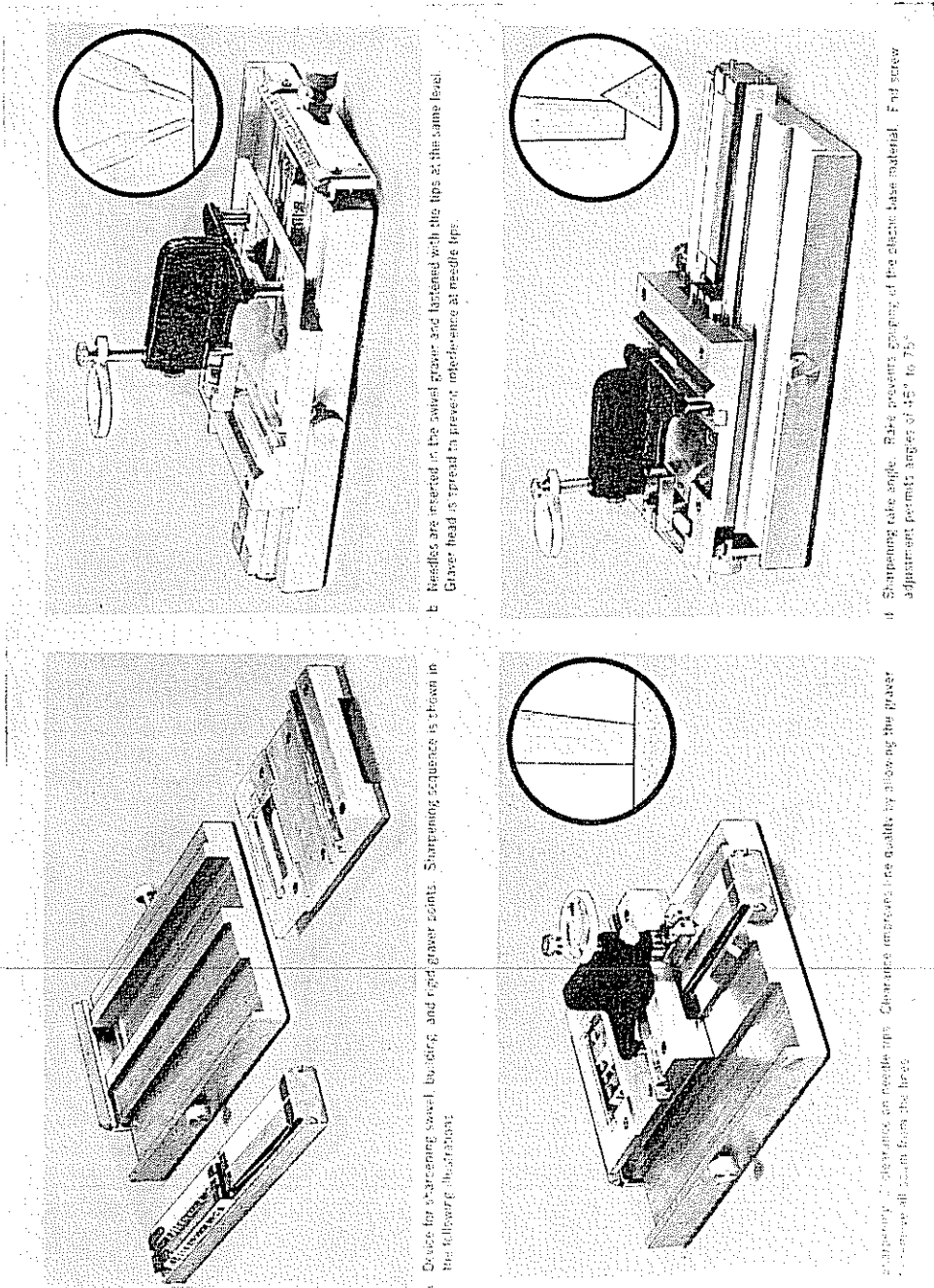

a. Device for sharpening sowl, building, and right graver points. Sharpening sequence is shown in the following illustration.

b. Needles are inserted in the sowl graver and hardened with the tips at the same level. Graver head is spread to prevent interference at needle tips.

c. Sharpening cube angle. Rubie prevents grinding of the electric base material. Feed screw adjustment permits angles of 45° to 75°.

d. Sharpening cube angle. Clearance improves line quality by allowing the graver to advance all points from the ledge.

Figure 76. Device for sharpening graver points and methods of use—1

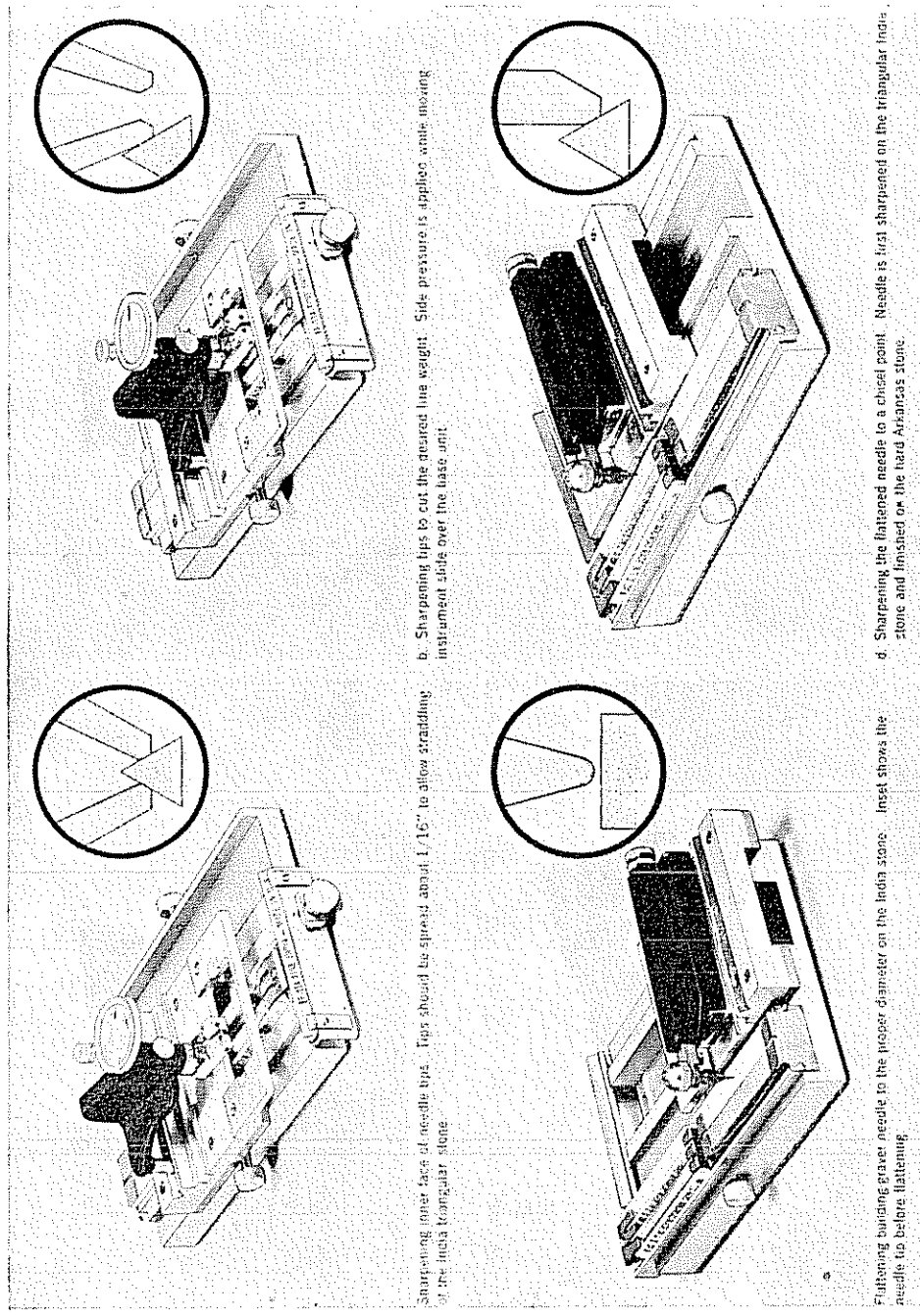

Figure 77. Device for sharpening graver points and methods of use—II

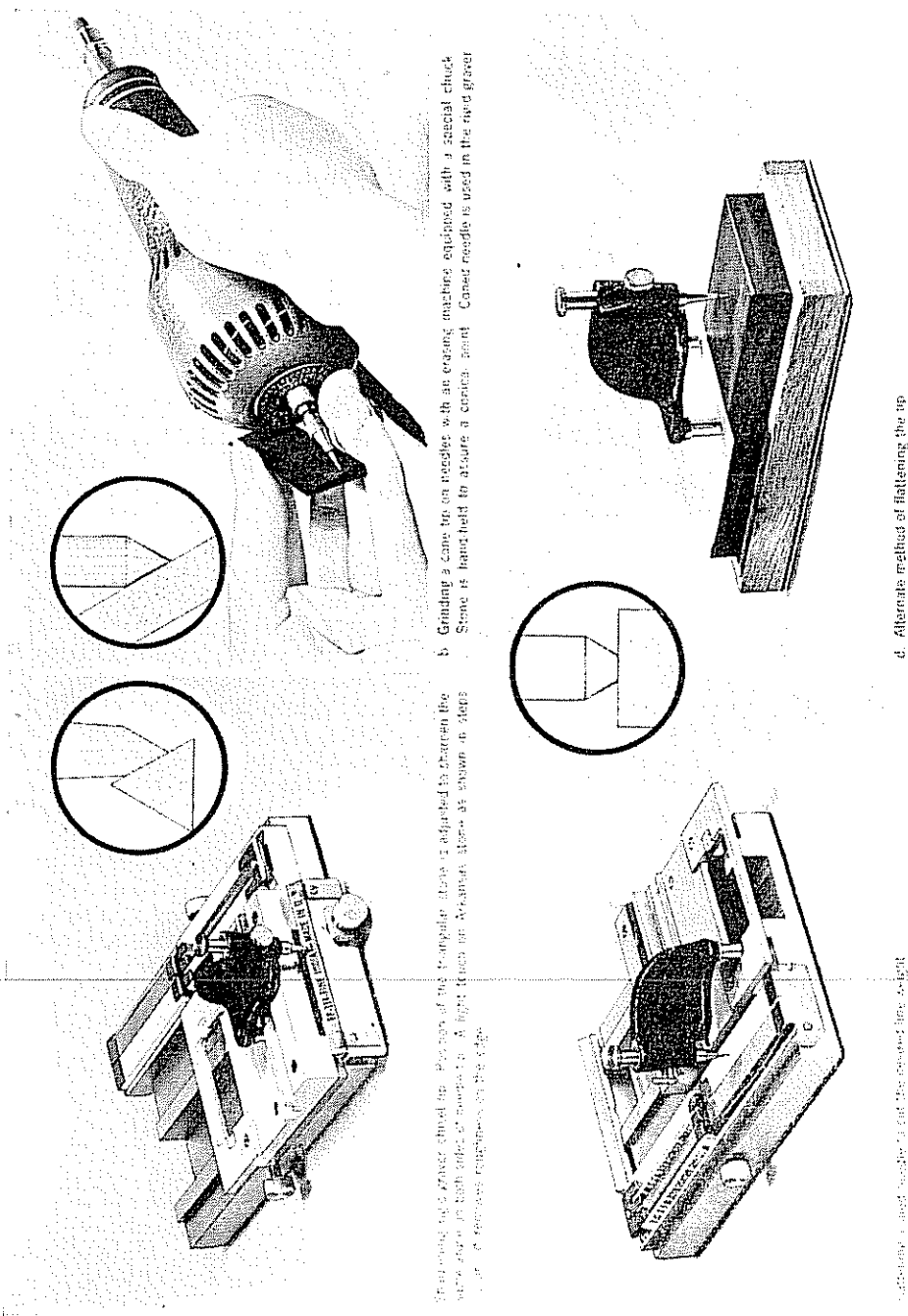

Figure 78. Device for sharpening graver points and methods of use—III

Maintenance of register

To gain maximum advantage from the contact processes made possible by scribed manuscripts, a punch-and-stud system has been devised which ensures accurate register of the separate map components. A specially designed punch (figure 79) makes two, three or four holes in the margins of the sheets, depending on the sheet size. The holes are of uniform diameter and are positioned so that any combination of quarter, half or full sheets can be

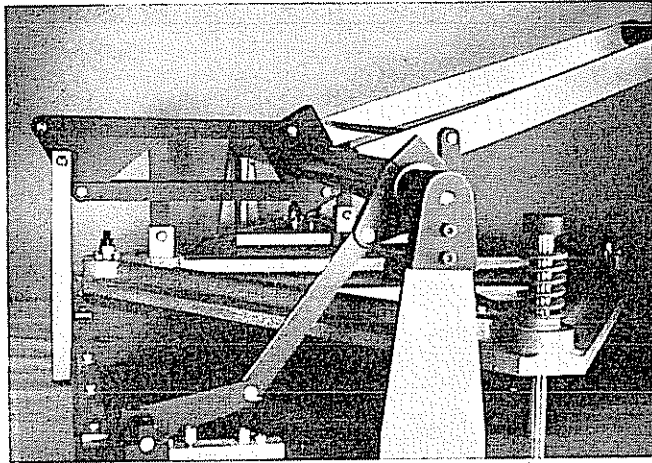

Figure 79. Register punch

fitted together in exact register by means of studs inserted in the holes. Scribed photogrammetric and field manuscripts are right-reading and are punched in a face-up position. Colour separation guides are left-reading and are punched face down. The punch-and-stud system is used throughout the mapping and map finishing phases and has been adopted in slightly modified form in the reproduction plant.

Processing the image

Wipe-on colour-proving sensitizers have been selected for use in preparing scribing guides because of the variety of colours. Black or blue emulsion is commonly used for basic guide images. A contrasting colour, usually red or green, is selected for supplementary data which must be surprinted on the basic image.

Topographic maps are normally printed in six colours: black for culture and most lettering; brown for relief information; blue for streams, open-water outlines and spot water features; blue tint for open-water areas; green tint for woodland, and red for road classifications and destinations and public land subdivisions. For maps of the 7.½-minute series, basic guide images are provided by contacting both the planimetry and relief manuscripts to three sensitized scribe sheets designated as the black, brown and blue guides. Another sheet is exposed to the planimetry only, or to a separate woodland compilation, to serve as the green guide. The basic guides are then resensitized in a contrasting colour, and the scribed field corrections are surprinted over the existing images. The red guide is prepared by processing the field corrections to another sheet which later will receive road images from the scribed black plate. The blue tint guide is prepared later by contact printing the scribed blue plate to another coated sheet. Other supplementary guides,

such as for red tinted urban areas and light brown sand or lava patterns, if required, are prepared by exposure to the appropriate source material. In all of these contact printing operations, emulsion-to-emulsion contact reverses the image, and emulsion-away contact (printing through the base material) preserves the original orientation.

For maps of the fifteen-minute series, the 1:24,000-scale manuscripts are photographically reduced to 1:48,000 scale. Thereafter, processing the scribing guides is simpler than for 7.½-minute maps, because the field completion data is already incorporated in the basic map image.

COLOUR SEPARATION SCRIBING

After the guides have been prepared, a necessary preliminary to colour separation scribing is the application of projection lines and projection and grid ticks. Because of the great precision required, one competent scriber applies all of these features to the appropriate guides. The entire projection border and the 2.½-minute or five-minute intersections, depending on the map series, are scribed on the black guide. Only the four corners are scribed on each of the other guides, to serve as reference points for subsequent operations which require exact location of the map borders. State and UTM grid ticks also are scribed at this time, on the black and blue guides, respectively.

Lettering plate

Information which is to appear in black on the published map normally is divided between two plates, one for the lettering and one for the symbolization of culture. The lettering plate is prepared with positive stick-up on a transparent Mylar overlay, and contains marginal data, feature names and descriptive labels. The overlay is placed over a composite print of the scribed black, brown and blue plates during the application of lettering or a composite guide image of those plates is printed in light blue directly on the Mylar sheet. When completed, the positive lettering plate is contact printed on stable film to obtain a negative which is utilized in the same manner as a scribed plate in subsequent processes. The lettering plate also serves as a convenient medium for showing with positive stick-up the few culture symbols that are difficult to scribe with present equipment. In addition, area patterns which are to be printed in black are sometimes placed on the lettering plate as an alternative to the use of negative stick-up on the scribed culture plate.

Black (culture) plate

Because works of man are essentially regular in shape, mechanical aids are used with the gravers in scribing most cultural features. Straight linear features are scribed along a straightedge. Smooth curves are executed with the aid of a metal curve or the smoothly swinging action of the swivel graver. Small cultural features are represented by standard symbols, most of which are scribed with the aid of the templates illustrated in figures 75 and 80. Roads are scribed with a swivel graver equipped with a double-pointed blade or two phonograph needles. Dual lane highways are scribed with a specially designed swivel graver which uses three or four phonograph needles. Railroads are scribed with the swivel or rigid graver; cross-ties with the rigid or pen-type graver. Dashed lines, such as trails, pipelines and boundaries, are first scribed solid. The required spaces are then blocked out with a commercial opaquing fluid or with a half-and-half mixture

TOPOGRAPHIC INSTRUCTIONS
SUPPLEMENTAL INSTRUCTIONS ON NEGATIVE SCRIBING—CHAPTER 4B2
MAP SYMBOL TEMPLAT

The 015" gage templet is designed for scribing symbols at the scales of 1:24 000 and 1:48 000 when used with a standard unsharpened steel Duotone needle

The working edge of the guide is shown with a heavy line at the scribing step indicated. Symbol sizes are illustrative only

* Use straightedge with templet when scribing these symbols

† Sharpen Duotone needle to scribe specified symbol line weight

§ Symbol is shown in positive position

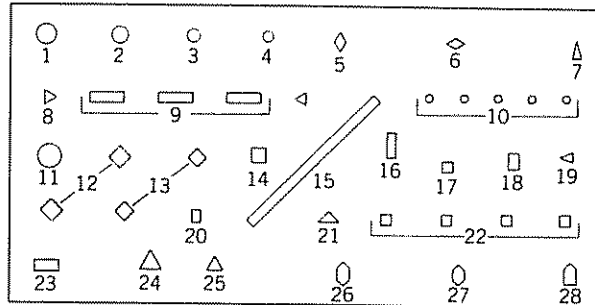

SYMBOL		GUIDE		SYMBOL		GUIDE AND SCRIBING SEQUENCE	
134		1		117		8	
138		3				9	Space and align ties with triangular guides
140		† 22		131		9	Make RR track, then shift templet 1/2 space
141		27		165		*	After a line is scribed, hold position with the graver point, then shift the templet for the next scribing position. For cross-hatched building fill use a larger shank needle to reduce line spacing to .017.
142		26		176		15	
143		3		166	§	* 17	
160		† 22				18	
162		† 22		168		* 16	
175		22		183		11	
186	§	12				12	
194				184		28	
235				185		5	
426				187		10	
427				199		* 6	
198		3				7	
216		25		200	§	2	
226		12				22	
501		12		220		12	
227		21		318		13	
407		† 22		237		8	
425		22		246		22	
441		† 14		314		20	After a line is scribed, hold position with the graver point, then shift the templet for the next scribing position.
443		† 14		255		13	Scribe X as in Symbol No 318, then place point of guide as shown and scribe the spade tip. Close spade by clearing out the area.
						6	

Figure 80. Map symbol templets

of red an yellow Flo-Paque thinned with Varsol. Houses and other small, solid squares or rectangles are scribed with the building graver or with the rigid graver and building guide.

Brown (contour) plate

Contour lines represent largely irregular natural ground formations; therefore they are irregularly curved lines, which are best scribed freehand except where their shape has been altered by works of man. Index (heavy) contours are scribed with the rigid graver and intermediate (light) contours with the rigid graver or pen-type graver, according to the preference of the scriber. Supplementary contours, scribed with the pen-type graver, are lines of very short, closely spaced dashes which have the appearance of dots when reproduced in brown. Levees and spoil banks usually are shown by scribing openings of the proper width and applying the hachure symbol with negative stick-up. Area patterns, such as sand and lava, which are to be printed in brown, are usually prepared on a separate plate allowing them to be printed in a light brown colour to prevent the obliteration of other detail on the brown plate.

Brown lettering (contour values and unchecked elevation figures) is applied in negative form to the brown plate. In the standard method, windows just large enough to accommodate the numbers are cleared of coating with a spading tool and templets of proper size. Each stick-up label is cut with sufficient margin to extend slightly beyond the edges of the window, thus preventing the passage of light around the label and providing a narrow space between the number and the adjacent contours. Where suitable coatings are available, lettering sometimes is etched through the coating of the brown guide before the guide image is printed thereon. The etching process is described fully in the section dealing with procedures under development. Also described are two gravers which have been used for scribing numbers directly on the brown plate.

Blue (drainage) plate

Natural drainage lines, such as streams and shorelines, are scribed freehand with the rigid graver. Aqueducts, ditches, wells, etc. are scribed by the techniques used for similar culture symbols on the black plate. Intermittent stream and ditch symbols are made by first scribing dashes of the proper length and spacing, then adding the dots with the dot graver. Dotter points are sharpened to a pyramid point as shown in figure 81. Small areas of marsh or swamp are scribed. Large areas are prepared as clearings on a separate negative plate, which ultimately is reproduced through a marsh pattern contact screen. Other area patterns are applied to the blue plate with negative stick-up unless the areas are very small, in which case they are scribed. Blue lettering, normally very sparse, is applied in the same manner as brown lettering.

Blue tint plate

A negative blue tint plate is prepared for any map having perennial or intermittent open water areas of considerable size. If the areas are small and not too numerous, a tint effect is simulated by scribing a pattern of small, closely spaced dots on the drainage plate. Perennial water areas are shown on the blue tint plate as cleared areas. Blue tint patterns are either scribed or applied with negative stick-up, depending on the size and complexity of the areas.

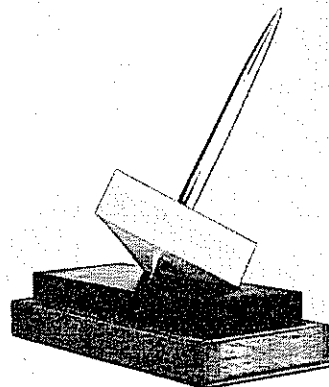

Figure 81. Dot graver sharpened to a pyramid point

Red plates

Public land subdivisions, road classifications and destinations, and urban area tints are shown in red on Geological Survey maps. Also, some boundaries are accented with a red tint strip along the inside of the black symbol. Normally, two red plates are prepared—one containing the land survey data, the other the road data. If a map contains areas that require the urban tint, a third red plate is prepared in open negative form suitable for half-tone screening in reproduction. Most red symbols are scribed on their respective plates by the techniques used for scribing similar culture symbols on the black plate. Dotted land lines are applied with negative stick-up. Boundary accents are applied in a similar manner or, if there is an urban tint plate, are shown on it as open strips. Red lettering is applied in negative stick-up form.

Green (woodland) plate

The green plate depicts and classifies the woodland features, which are printed on the published maps in a light green tint. Timbered areas are simply cleared of coating. Scrub, orchard and vineyard patterns are applied with negative stick-up, or if areas are large or numerous, separate plates are prepared for processing through a contact pattern screen after the areas have first been cleared as for timber. The use of etchable strip coatings, as described in the section on procedures under development, has greatly facilitated the preparation of these and other tint plates.

Flow diagram

The accompanying flow diagram (figure 82) illustrates the simplified colour separation cycle made possible by the adoption of scribing in all mapping phases to which it is applicable. Not that the transfer steps are accomplished without the aid of the copy camera. In current practice, this procedure applies to 7.½-minute quadrangle maps. Stereocompilation, field completion and colour

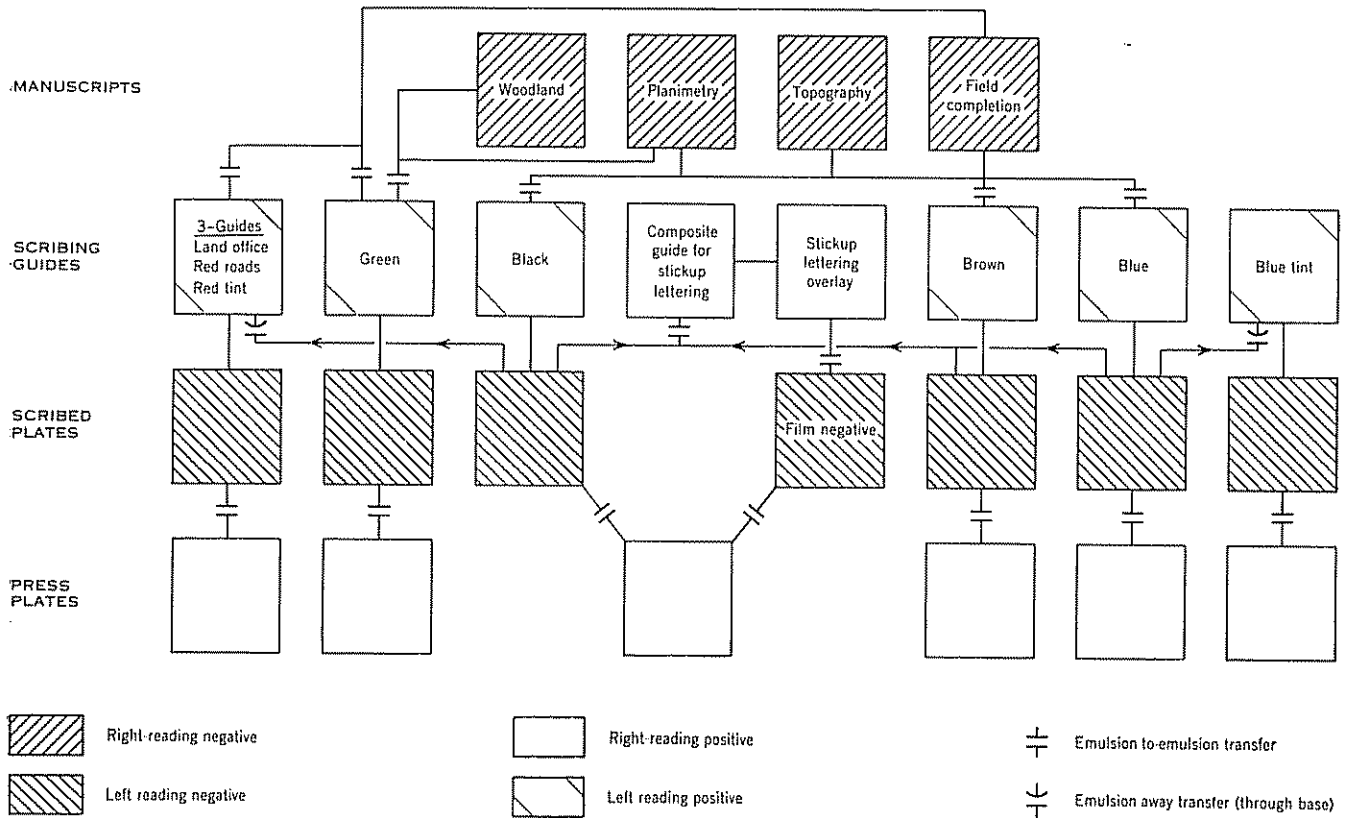

Figure 82. Flow diagram of basic colour separation procedure

separation are all accomplished by scribing at the publication scale, 1:24,000. Because of special requirements for the ready availability of 1:24,000-scale coverage, most fifteen-minute maps are also compiled and field completed at that scale. They are colour separated at 1:48,000 scale, for final reproduction at the scale of 1:62,500.

For the sake of clarity, proving and editing, steps have been omitted from the flow diagram. The nature of scribed colour separations is such that proofs can be made with equal facility at any stage of the procedure. A proof may be of one plate or a composite of several and may be either monochrome or multicolour, according to the requirements of checking and editing personnel. The recent trend has been toward multicolour composites. The number of proofs made and their location in the cycle are determined by edit procedures and photolab capacities in the Area offices.

SCRIBING IN OTHER MAPPING PHASES

To derive maximum benefit from the scribing technique, the Geological Survey has moved toward complete utilization of scribing in all operations formerly done by pencil or ink drawing. In the newest procedure, stereo compiled and field surveyed manuscripts are fully scribed. The initial "rough" compilation is done in pencil on 500-gauge, scribe-coated Mylar, then "dressed up" by scribing, rather than with pen and ink as in the past. The planimetry is compiled and scribed first, then contact printed to another sheet to serve as a base for the separate relief compilation. The two compilations, when complete in photogrammetric detail, are printed together in accurate

register on 750-gauge, scribe-coated Mylar. This copy, usually in the form of two half sheets, is taken to the field where the engineers plot and scribe all additions and deletions necessary for completion of the map, as determined by plane table surveys and other on-the-spot investigations.

Because stereocompilation and field scribing normally are not directly reproduced for publication, they are subject to less rigorous standards of appearance than is colour separation work. The basic instruments used for colour separation are equally suitable for compilation scribing, and special kits containing the necessary instruments and accessories have been assembled for field use.

PROCEDURES UNDER DEVELOPMENT

Salvage of compilation scribing

The adoption of similar techniques, materials and scales for both the mapping and map finishing phases offers the possibility of eliminating some of the duplication of effort that has always existed in the map production cycle. Experiments conducted by the Survey indicate that salvage of the separate contour compilation for colour separation use is feasible where few field corrections are encountered. With the conventional right-reading compilation, the press plate exposure must be made through the base material. To lessen the quality deterioration inherent in the emulsion-away process, this "final" compilation scribing has been done on 300-gauge material, although there is some indication that the precaution is unnecessary. Also, several maps have been compiled

experimentally from reverted models to produce left-reading manuscripts, and the results obtained have been promising. However, the prospect of doing finished scribing in the compilation phase introduces personnel problems and other administrative difficulties which tend to lessen the potential benefits.

Photomechanical etching

The rather tedious process of clearing for and placing negative stick-up has stimulated research towards better methods of applying patterns and labels to the scribed plates. An etching process has been used with considerable success on some coatings. The lettering or pattern is applied to a transparent Mylar overlay with positive stick-up before the colour separation guide is prepared. The completed overlay is contact-exposed to a scribecoat sheet which has been sensitized with an etch-resistant emulsion. When developed, the image is etched through the scribe coating by rubbing it with a piece of cloth, absorbent cotton or developing pad moistened with a suitable solvent. After etching has been completed, the resistant emulsion is washed off and the guide image for scribing is printed on the sheet in the normal manner.

Full utilization of the etching process has been hampered by the fact that intricate symbols and lettering styles are difficult to etch cleanly and uniformly. Too much solvent or rubbing undercuts the resist and breaks down the outlines; too little causes incomplete etching and the loss of fine detail. The quality of etched detail depends to a great extent upon the skill of the operator. Not all coatings are suitable for etching, but the whirled Flo-Paque coating described earlier gives good results as do some of the more recent commercial coatings. For the Flo-Paque coating, a Pitman positive albumin solution, developed with positive developer, is used for the resist. The etching solvent is a mixture of three parts methyl alcohol and one part ethyl acetate.

Scribed lettering

Two types of gravers have been developed for scribing lettering directly on to the plates. One of these is a pantograph device, the other a LeRoy-type graver. Both of these devices have been used for scribing contour values and spot elevation figures. However, further development work is needed before they can be used to good advantage by the average scribe. The pantograver will require the development of a spring-loaded point assembly or other improvements that will ensure an even scribing pressure. The LeRoy-type graver will require the development of an improved templet. Glass, metal, hard plastics and various laminates of these substances have been tried as templet material but to date no method has been found to produce templets having grooves of the required hardness and smoothness.

Strip coatings

Considerable effort has been directed toward the development of coatings that can be etched and peeled from the Mylar base. Although results have been encouraging, the best compromise between ease of stripping and permanence of unstripped material has not been reached. Various gelatin-base coatings have been used, but these tend to change with age and either adhere too tightly to the base material or peel off in normal handling.

Metallic Graph-Strip, the newest of the strip coatings, consists of 0.001-inch aluminium foil thermoplastically mounted on Mylar and sensitized with No. 6 Kodak Resist. It is exposed under a positive image for about 90 seconds at 30 inches from a 45-ampere arc lamp, then developed by dipping for about 30 seconds in a tray of KPR developer or by flowing with the developer in a whirler. The developed resist is flowed with KPR dye to give the image better contrast and is set by washing with water until all the surplus dye is removed. After being blotted dry, the negative is ready for etching with a solution prepared as follows: dissolve calcium chloride in water to 38° Baumé; dissolve cupric chloride in water to 38° Baumé; mix two parts of the first solution to one part of the second solution. The image is etched by immersing the sheet and swabbing with cotton for about one minute, or until all lines are clear of metal. The etched negative is rinsed with clear water, wiped with wet cotton to remove sludge and dried.

Series conversion by direct photoreduction

The principal map series produced by the Geological Survey are the 7 1/2-minute series, published at 1:24,000 scale, and the fifteen-minute series, published at 1:62,500 scale. These are customarily scribed at 1:24,000 and 1:48,000, respectively, using identical symbolization for each scale. Coverage of the same quadrangle areas with maps of both series is often desirable. Heretofore, this has been accomplished by reducing sets of four 7 1/2-minute maps to 1:48,000 scale, assembling them in fifteen-minute format and processing guide images from the assembly for complete rescribing with standard symbol sizes. This type of scribing is difficult because of the necessity for enlarging the symbols shown on the guide image and providing proper clearances to maintain accurate colour register.

The refinement of line quality inherent in scribing suggests the possibility of converting 1:24,000-scale maps to 1:62,500 by direct photographic processes, without serious loss of legibility. Experiments performed in this direction indicate that the majority of map features, except lettering, probably can be converted in this manner. If confirmed by further experimentation now in progress, the photographic procedure can be adopted, at a significant saving over present series conversion costs.

III. Glossary

FOREWORD

Scribing terminology is largely an adaptation of standard words and nomenclature already established in the closely associated technical languages of cartography and the graphic arts which describe the physics, mechanics and

chemistry of drafting, engraving, photography, lithography and printing.

This glossary lists only words or combinations of words peculiar to scribing or those used to convey a distinct meaning in the "scribing sense" which may otherwise

be obscure or confusing. In instances where a particular scribing term is either self-descriptive or by common definition self-explanatory, the term is omitted. In general, standard dictionary words and terms common to established technical nomenclatures are omitted.

The purpose of the glossary is explanation and clarification of intended meaning rather than rigid definition.

Albumin (albumen) process

A process of making photolithographic press plate utilizing bichromated albumin as the photosensitive coating

Base image

An image composed of basic map data in varying degrees of completion, upon which additional data may be surprinted, scribed or otherwise applied. Usually controls the position of any superimposed image.

Base material

In negative scribing, the material to which the scribe coating is applied

Blades (scribing instruments)

Thin, flat, steel blades shaped to produce lines of specific widths. Used in swivel graver to engrave roads and the like, or in straight line graver to engrave straight lines in conjunction with straight-edge. Often notched so as to cut two or more parallel lines.

Block out

The deletion of areas or images on a scribed or photographic negative by opaquing or other means. Sometimes used to indicate an interposed negative or positive employed as a mask.
See "mask".

Blueline

A blue image on any medium.
See "photoprint".

Bromide print

Brown print

Brownline print, etc.

See "photoprint".

Casing (multiple-line road symbol)

The outside lines of a road symbol.

Colour composite

A composite in which the component images are shown in different colours.
See "composite".

Colour plate

The press plate from which any given colour is printed. Also, by extension, a drawing or negative prepared for a particular colour.
See "colour separation".

Colour separation

In scribing, the procedure of making a separate engraving for each colour required for multicolour reproduction. This may be termed "physical isolation" of the colours, as distinguished from photographic isolation (commonly used in the graphic arts) by means of coloured filters and photosensitive materials.

Compilation (map or chart)

The process of assembling, in map form, data extracted from existing maps, charts, aerial photographs and other sources.

Compilation manuscript (map or chart)

The immediate product of the act of compilation. A map or chart "in the rough".

Composite

A print consisting of two or more images surprinted in register to form one image.
See "colour composite".

Contact (photoprinting)

Said of photographic exposures made by placing the medium, such as film or paper, receiving the image in contact with the medium from which the image is to be transferred. No camera or lens system is used in contact exposure.
See "emulsion-away" and "emulsion-to-emulsion" exposure.

Density (scribecoat)

The light-retarding quality of a given scribe coating. The larger the quantity of pigment or the greater the saturation of dye in the coating, the greater the density is said to be.

Emulsion

A suspension of a light-sensitive material, as in a colloidal medium, used for coating photographic films, plates or papers. By popular usage, any coating, whether or not it is photosensitive.

Emulsion-away (exposure)

A contact exposure in which the emulsion of the copying film is on the side of the film opposite to that in contact with the sheet being copied.

See "emulsion-to-emulsion" and "contact".

Emulsion-to-emulsion (exposure)

A contact exposure in which the emulsion of the copying film is in contact with the emulsion of the sheet being copied.

See "emulsion-away" and "contact".

Gradient tints

Tinted areas on a map or chart, normally in the form of bands following the contour pattern, used to indicate ranges of altitude. Gradient "bands".

Graver (instrument)

The instrument as distinguished from the user.

Guide

Information, usually graphic, used as a guide in scribing or allied operations. For example, an image of the compilation manuscript may be reproduced on a sheet of scribe coating, which becomes a "scribing guide" for the engraver. The image itself is a "guide image" or "scribing guide image".

Also, there are several kinds of reference guides, such as "colour guide", "tint guide", "correction guide".

Image

A visible representation.

Image direction

Images may be "right-reading" (reading from left toward right) or "left-reading" (reading from right toward left). This terminology applies only when the image is viewed from the face or coated side of the supporting medium.

"Right-reading" is analogous to the reading of a book, while "left-reading" is the opposite—or backwards. The same relationships apply to map images and other graphic representations. Other terms, such as normal-reading, reverse-reading, wrong-reading, natural-reading, backward-reading and forward-reading, are sometimes used to identify image direction, but are not recommended because of possible confusion in negative-position relationship.

Image plane

In general, the coated side or sensitized surface of a scribe-sheet, photographic film or plate, etc. Often called the "face side" or "face".

Left-reading

See "image direction".

Manuscript

A very general term in modern cartography. Not recommended for use without adequate qualification.
See "compilation manuscript".

Mask

In photomechanical processing, to block out an area by means of actinically opaque material, to prevent exposure in the part blocked out. Also, the covering material itself when so applied.
See "opaque" and "block out".

Negative

A very general term, derived from photographic terminology based on camera photography and defined by most dictionaries as: "Exhibiting the reverse; showing dark for light and light for dark: as a photographic negative plate or film". There are several kinds of negatives and several ways of producing them in the modern photographic-scribing-cartographic complex. A scribed sheet is essentially a manually produced negative.

Opaque

Not transmitting light. Also, not transmitting the particular wavelengths (which may or may not be visible) which affect given photosensitive materials. Thus, a substance may be opaque to some colours and not to others. It may be visually transparent, yet actinically opaque.

Also, a material applied to areas of a sheet to make it opaque in those areas

Also, to apply such a material.

Overlay

(a) A sheet containing explanatory or modifying data, placed over and keyed to existing or basic copy.

(b) Additional data, or a pattern, printed after the other features, so as to "overlay" them.

Overprint

(a) An image intentionally printed over or "on top of" another image to supply additional information or modify the basic image. Also, to make such a print.

See "surprint".

(b) A feature of a composite map image accidentally printed so as to interfere with another feature.

Photoprint

The product of any of several photomechanical processes or methods used to obtain a positive or negative facsimile. The photoprints obtained are usually referred to by names indicating the processes used, the appearance of the print or a familiar trade name of a process. Examples are:

Ammonia process, diazo, ozalid, blue print process, blueprint, blueline, bromide process, bromide print, contact print, colour proving process, ansco proof, colorline, watercote, direct copy process, autopositive, duplicate negative, van dyke process, brown print, brownline, and sepia.

Photomechanical

Pertaining to or designating any process of producing pictures or copies by a combination of photographic and mechanical operations.

Photostencil

A resistive, photosensitive coating through which an image has been "developed out" to permit an externally applied dye solution or etching medium to enter and act upon the surface beneath. Restricts such action to the imaged areas, thereby producing a dyed or etched image on the surface beneath. The stencil is usually, though not necessarily, removed after it has served its purpose.

Positive

Generally opposite to negative. In photography, resembling the original photographed object in light-and-dark relationship. There are several kinds of positives and several ways of producing them in the modern photo-scribing-cartographic complex. An inked drawing is essentially a manually produced positive. A conventional photographic print from a scribed negative is a positive

Register

The correct position of one component of a composite map image in relation to the other components.

Right-reading

See "image direction".

Scribe (scribe)

See part I of the present paper

Scribe coating

See part I of the present paper.

Spading

Removing scribe coating from the base material by use of a wide flat blade.

Stick-up (stickup)

Adhesive-backed film or paper on which map names, symbols, descriptive terms, etc. have been printed, for application in map and chart production.

Surprint

An image intentionally printed over, or "on top of" another image.

A number of images may be surprinted one after another.

Also, to make such a print.

Bibliography of scribing

- 1942 "Building Graver-subdivider". June issue of *Lithographic Journal*. Wm. Stevens
"Rigid, Swivel, and Fineline Gravers". September issue of *Lithographic Journal*. Wm. Stevens
- 1944 Reports of the Research Section. USC & GS
- 1945 Map Reproduction Gravecote Yellow. Coated plastics. 1 page. Research Bulletin No. 4. USC & GS
- 1946 Map Reproduction Duplicate Gravecote Negatives. Etched negatives. 1 page. Research Bulletin No. 6. USC & GS
- 1947 Lithographic Procedure for Revising the Nautical Chart-Correction Scribing on Glass. 2 pages of text, 13 pages of illustrations. USC & GS
Plastic Sheets in Lithographic Production. Scribing on plastic. 3 pages of text, 7 pages of illustrations. USC & GS
- 1948 Map Reproduction Glass Negative Engraving. 4 pages of text, 8 pages of illustrations. D. P. Barnette. USC & GS
- 1950 "Plastic Sheets in Map Reproduction". 4 pages. April-June issue of *Surveying and Mapping*. Samuel Sachs. ACSM
- 1951 Etching or engraving on Vinylite. Interim report. ACIC
- 1952 Map Scribing on Plastic Sheets vs Ink Drafting. Samuel Sachs. USC & GS
Glass Drafting Report. 4 pages of text, 5 pages of illustrations, 6 pages of sample maps. AMS
- 1953 Map Reproduction Pigmented Process Transfers. 1 page. USC & GS
Plastic and Glass Engraving vs Drafting. 3 pages. C. F. Fuechsel. USGS
- Glass Scribing. 3 pages. Albert A. Gioiosa. AMS
Plastic and Glass Engraving vs Drafting. 5 pages, illustrated. Samuel Sachs. USC & GS
Plastic and Glass Engraving vs Drafting. H. W. Whitlock and D. K. Crook. SCS
Plastic and Glass Engraving vs Drafting. F. A. Clemens. ACIC
Current Trends in Cartography in the U. S. 7 pages. C. F. Fuechsel. USGS
- 1953 Map Reproduction Resistopake Negatives. 1 page. USC & GS
Instructions for Plastic Scribing with Drafting Equipment Set No. 13. 20 pages, illustrated. ERDL
"Recent Developments in Negative Scribing". 7 pages, illustrated. Oct.-Dec. issue of *Surveying and Mapping*. C. F. Fuechsel. ACSM
- 1954 Report 1339—Second Interim Report Cartographic Drafting, Methods and Equipment. Project No. 8-35-02-004. Plastic Scribing Process. 82 pages, illustrated. ERDL
Glass Scribing. 4 pages of text, 4 pages of illustrations. Fachhefte Bulletin Technische. No. 1, Zurich, Switzerland. Hans Stump
Progress Made in Cartographic Materials and Procedures. Special Report No. 1. 5 pages. USGS
"Scribing Today". 9 pages, illustrated. July-Sept. issue of *Surveying and Mapping*. C. F. Fuechsel. ACSM
Service Test of Plastic Scribing Set No. 13. ACIC
- 1955 Scribing Report on 1:1,250 and 1:2,500 Series. 18 pages of text, 3 pages of illustrations, 14 sample maps. British Ordnance Survey

- The Quick-etch Process Converting Engraved Coated Vinylite Sheets to Positives. 12 pages. Technical Report No. 66. ACIC
- Engraving on Coated Vinylite. 19 pages. Technical Report No. 3. ACIC
- Bulletin No. 34. Plastic scribing. 30 pages, illustrated. AMS
- Future Trends in Map Production. Brigadier M. O. Collins, C. B. E., Director of Map Production, British Ordnance Survey
- Plastic Engraved Aeronautical Video Plates. Technical Report No 72. ACIC
- "Scribe Coatings Blossom Out". 3 pages, illustrated. July-Sept. issue of *Surveying and Mapping*. Kenneth R. Deardorf. ACSM
- "Scribed Drawings Successfully Transformed into Effective Positives" 5 pages, illustrated. Oct.-Dec. issue of *Surveying and Mapping*. Kenneth R. Deardorf. ACSM
- 1956 Photogrammetric and Field Scribing. 8 pages. R. E. Altenhofen. USGS
- Recent Scribing Developments. 3 pages. ACIC
- Color Separation Drafting by the Plastic Scribing Method for Military Cartography. 19 pages, illustrated. ERDL
- Instructions for Color-Separation Scribing. Preliminary draft. 23 pages of text, 7 pages of illustrations. USGS
- The Photoscribe Process. Photomechanical etching of scribe-coated sheets. 5 pages. Technical Report No. 74. ACIC
- 1956 Cartographic Conference. Stockholm, Sweden. July 26-August 2. Papers and reports related to scribing, as follows:
- Photographic Reproduction of Engraved Copper Plates. 6 pages. S. de Brommer. Institut géographique national, Paris, France
- Army Map Service Rub-on Color Proving. 5 pages. C. S. Spooner, Jr. AMS
- Plastic Using in Operations of Compilation, Draughting and Revision. 5 pages. A. R. E. Dufour. Institut géographique national, Paris, France
- Scribing on Plastic. Today's results in the U.S.A. 5 pages. Samuel Sachs. USC & GS
- Some Recent Developments in Map Reproduction. 4 pages. C. S. Spooner, Jr. AMS
- Photo-Lettering and Photo-Positioning of the Cartographic Letterings. 13 pages with diagrams and illustrations. S. de Brommer. Institut géographique national, Paris France
- Printing Down Processes on Plastic Foils and on Glass. 5 pages. Hanns Eggen, Hanover, Federal Republic of Germany
- Copies, Duplicates, and Color Proofs on Plastic. 4 pages. Samuel Sachs. USC & GS
- Photo Composition Compared with Ordinary Typesetting. 3 pages. K. W. Bland. Great Britain
- Tools for Scribing. 5 pages. F. B. Meech. Great Britain
- Tools for Scribing. 1 page. D. Chervet. Switzerland
- Tools for Scribing. 7 pages. C. F. Fuechsel. USGS
- Some Actual Problems. 9 pages. Carl M. son Mannerfelt. Sweden
- Different Types of Plastic Sheets in the U.S.A. Samuel Sachs. USC & GS
- Utilization of Plastic Sheets for Compilation, Smooth Drafting and Corrections. A. R. E. Dufour, Institut géographique national, Paris, France
- Expanding the Applications of Scribing. 3 pages. C. F. Fuechsel. USGS
- News of the Cartographic and Surveying Fields. Series I: German Contributions and Information. Report on the Esselte Conference of Applied Cartography. 84 pages. E. Gigas. Institute for Applied Geodesy, Frankfurt-am-Main, Federal Republic of Germany

KEY TO PUBLISHING AGENCY

Many of the publications listed above are available for reference but not for distribution. Inquiries should be addressed to the appropriate publishing agencies, as listed below.

ACIC	Aeronautical Chart and Information Center Second and Arsenal Streets St. Louis 18, Missouri
ACSM	American Congress on Surveying and Mapping Box 470, Benjamin Franklin Station Washington 4, D. C.
AMS	Army Map Service 6500 Brooks Lane Washington 25, D. C.
ERDL	Engineer Research and Development Laboratories Fort Belvoir, Virginia
SCS	United States Soil Conservation Service North Laboratory, Agricultural Research Center Beltsville, Maryland
USC & GS	United States Coast and Geodetic Survey 14th Street and Constitution Avenue, N. W. Washington 25, D. C.
USGS	United States Geological Survey Topographic Division 18th and E Streets, N. W. Washington 25, D. C.

THE 1960 ORTHOPHOTOSCOPE¹

Technical paper by Roland H. Moore, United States Geological Survey

ABSTRACT

The Orthophotoscope is a photogrammetric instrument for converting conventional perspective photographs into uniform-scale orthophotographs in which the imagery is in true planimetric position. The conversion is accomplished by scanning an anaglyphic stereomodel in narrow bands, and enlarging the projected images inversely according to their scale. The restituted imagery is printed photographically on a film which is exposed differentially as the model is scanned.

The 1960 Orthophotoscope, described here, is the third in a series of such instruments developed during the past

¹ The original text of this paper, submitted by the United States of America, appeared as document E/CONF.36/L.49.

decade in the research laboratory of the United States Geological Survey. The design of the latest model has benefited from experience with the two earlier versions, and it incorporates a number of substantial improvements, as follows:

1. It accommodates both Kelsh-type projectors and ellipsoidal-reflector type projectors;
2. It provides for adjusting the scanning direction to permit scanning parallel to major terrain features;
3. It replaces the flat film-supporting platform with a twelve-inch diameter cylinder that rotates and translates automatically;
4. It provides self-synchronizing mechanisms for the transmission of x -, y - and z -motions to the scanning assembly;

5. It provides means of using the profile data from each scan, simultaneously or subsequently, to operate other image-restitution equipment or model-carving equipment, or to extract hypsometric information in digital or analogue form.

In redesigning the instrument, the comfort of the operator has been kept in mind as a major consideration. He is seated in a position where he has a nearly constant viewing angle during the entire scanning operation. The response to controls is smooth and automatic, requiring a minimum of physical effort. Experience has demonstrated that operator fatigue is a major factor affecting the accuracy of photogrammetric operations and that careful attention should be given to this factor.

Orthophotography is a promising new implement of photogrammetry, and it can be the core of a new mapping system. Experience has shown that the extent of its use depends on the geometry and image quality of the product. With the 1960 Orthophotoscope, substantial improvements in orthophotograph quality and reduction in the cost of preparation can be expected.

INTRODUCTION

The value of a uniform-scale photograph upon which precise horizontal distance measurements can be made without the necessity of applying corrections for image displacements due to tilt and relief has long been appreciated. Such photographs, which retain the detail provided by the images appearing on a photograph and present this information in correct planimetric position, have been prepared from conventional perspective photographs. The instrument designed to effect this conversion is called an Orthophotoscope and it may be defined, in general terms, as a photogrammetric restituting enlarger that magnifies the different images on a diapositive inversely as their scale. The 1960 model Orthophotoscope is the third of a series of these instruments developed in the research laboratory of the United States Geological Survey under the direction of Russell K. Bean. The design of this model has benefited from nearly a decade of instrumental development and experience in the preparation and application of orthophotographs.

EARLIER MODELS

The first Orthophotoscope, referred to in earlier papers as the experimental or "bread-board" model, was completed in 1953². Although considered crude, this first model served a useful purpose by demonstrating the soundness of the principles involved and the practicality of the design employed. The products of this first instrument were evidence that the images on perspective photographs could be restituted so that, for practical purposes, uniform-scale photographs were obtained. It was learned, too, that instrument stability was a more important factor in the preparation of orthophotographs than instrument portability. This finding is reflected in the sturdier design of the subsequent instruments.

The second Orthophotoscope, the engineered prototype, was fabricated in 1956. The value of the many improvements incorporated in this instrument was readily apparent in the improved quality of the resulting orthophotographs. This instrument has been operating on a full-time production basis since it was completed and

² R. K. Bean, "Development of the Orthophotoscope", *Photogrammetric Engineering*, v. XXI, No. 4, September 1955.

many orthophotographs and orthophotomosaics have been prepared. Operational research led to the development of more efficient procedures. Operating practice and experience increased the skills of the personnel who prepared uniform-scale photographs. As might be expected, the cost of preparing orthophotographs was reduced and the geometric and photographic quality of the product was improved.

The orthophotographs prepared with this instrument were furnished to geologists, foresters, hydrologists and engineers to alleviate field mapping problems caused by the lack or inadequacy of map coverage in their areas of interest. From the comments and evaluations of users of orthophotographs it was concluded that, first, when the benefits to be derived became known, the demand for orthophotographic coverage would exceed the capacity of this instrument, and secondly, that the purposes for which orthophotographs may be effectively used and the methods that may be employed in their use were largely dependent upon the geometry and image quality of the orthophotograph. It was recognized that significant improvement in the quality of the orthophotograph was hindered by the mechanical limitations inherent in the 1956 instrument. Experience also showed that physical discomforts imposed upon the operator by the instrument were unduly fatiguing. For these reasons the procurement of additional Orthophotoscopes, mechanically improved and designed with operator comfort as a prime consideration, was advised.

Other developments also influenced the design of the latest model Orthophotoscope. The success achieved in preparing orthophotographs makes it evident that the Orthophotoscope can be the core of a new mapping system. For example, the United States Army Map Service proposal, at present under study, envisions the possibility of obtaining several useful map products from the single exercise of profiling a stereoscopic model. In addition to obtaining orthographically restituted imagery, the proposal includes the extraction of contour information, the recording and storage of the profile information, and the construction of master terrain models. The 1960 Orthophotoscope has been designed to be compatible with these objectives.

FUNCTIONAL DESIGN OF 1960 ORTHOPHOTOSCOPE

Unlike the earlier instruments which rested upon supports designed for other purposes, the 1960 Orthophotoscope (figure 83) is functionally designed from top to bottom. The supporting structure, an integral part of the new instrument, is sturdy enough to provide the desired stability. The ways along which the scanning apparatus travels have been machined precisely. These physical improvements will reduce, if not eliminate, the registry of scanning "tracks" on the negative. These fine lines, caused by voids (non-exposure) and overlaps (double exposures), often appeared on the orthophotographs prepared with the earlier instruments, and were evidence that, due to mechanical limitations, the exposing aperture failed to traverse exactly contiguous areas of the negative as adjacent strips were scanned. Although these lines do not disturb the position of images, their presence degrades the appearance of the product.

As shown in figure 84, the new instrument structure is designed to accommodate the supporting bar both for Kelsh-type stereoplotters and for the ellipsoidal-

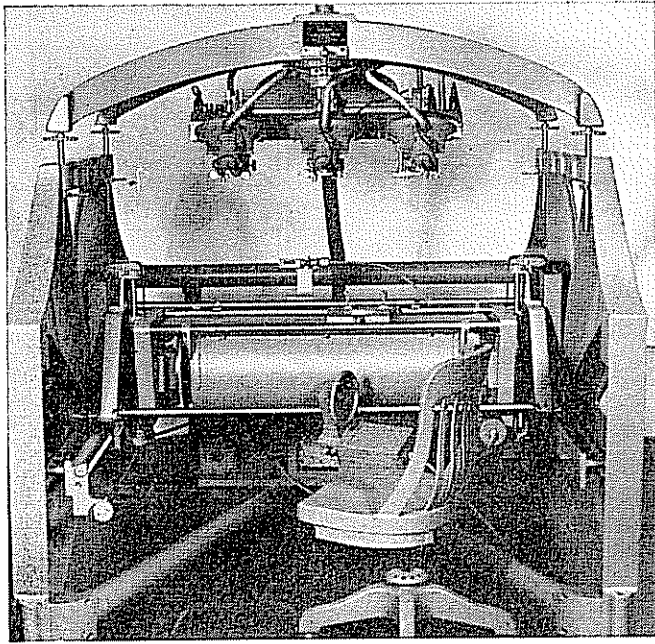

Figure 83. The 1960 Orthophotoscope with ER-55 projectors

reflector type. Because the Geological Survey has an abundance of both types in constant use, the diapositives available for a given area are likely to be compatible with one of these types of projectors but not with the other. For this reason, the flexibility in the type of projector that can be used with the Orthophotoscope constitutes a decided operational advantage.

Experience has indicated that the efficiency and the product of scanning is enhanced when the direction of scanning conforms with the physiography of the terrain. For example, in areas where the direction of prominent ridges and valleys is nearly uniform, the scanning operation is facilitated when performed in a direction parallel to these major features. Provision for adjusting the scanning direction has been included in the new instrument. The supporting bar for ER-55 projectors may be rotated about a vertical axis to permit a deviation between the direction of scan and the air base or flight direction.

The most striking modification in the new design is the replacement of the flat film-supporting platform with a twelve-inch diameter cylinder. This cylinder, around which the blue-sensitive film is attached, is thirty-two inches long and is enclosed in a light-tight outer drum. The cylinder and its concentric drum-shaped envelope are aligned with their longitudinal axis horizontal and parallel to the x -direction of the instrument. The platen carriage containing the scanning aperture is mounted on a track that extends the length of the outer drum. The track is fixed to the top surface of the outer drum, permitting the scanning slit to traverse the length of the inner cylinder. The entire assembly of the drums, platen carriage and track can be raised or lowered as a unit by the operation of a manual control. The emulsion of the film is exposed, through the scanning aperture, to small differential areas of the stereoscopic model surface as the platen carriage moves along its track. Although the film is exposed to both the red and blue projected rays which create the anaglyphic model, only the blue rays have an actinic effect on the film. The travel direction of the

platen carriage is alternately from left to right and from right to left, the reversal occurring after the completion of each scan.

Two automatic, synchronized motions take place when the end of a scanning path is reached. The inner cylinder is rotated about its longitudinal axis, and the assembly of the drums and platen carriage is translated in the y -direction. The amount of cylinder rotation is precisely that necessary to place the unexposed section of film immediately adjacent to the film area previously exposed into position under the path of the scanning slit. At the same time, the assembly is translating the distance necessary to scan a path across the stereoscopic model adjacent to the previous path. The synchronized rotation and translation must therefore be set to agree with the width of the scanning path. Adjustments are provided for scan widths ranging from 1.0 mm to 24.0 mm.

Several important advantages accrue from this drastic change in design. It is generally easier, and therefore cheaper, to machine a cylindrical surface to a specified tolerance than to machine a flat surface to the same tolerance. Those who have had experience in attempting to force photographic film to lie in a flat plane will appreciate the fact that it is much easier to place it around and in contact with a cylindrical form.

The more important advantages anticipated as a result of this change in design are operational. The operator will be in a comfortable, seated position during the entire scanning operation. By moving his chair forward as the cylinder is translated from its starting position at the front side of the instrument toward the rear of the instrument, the operator will have little difficulty in maintaining an advantageous and nearly constant viewing angle and distance to the scanning aperture. These gains are significant because the operator formerly stood bent over during the scanning procedures; moreover,

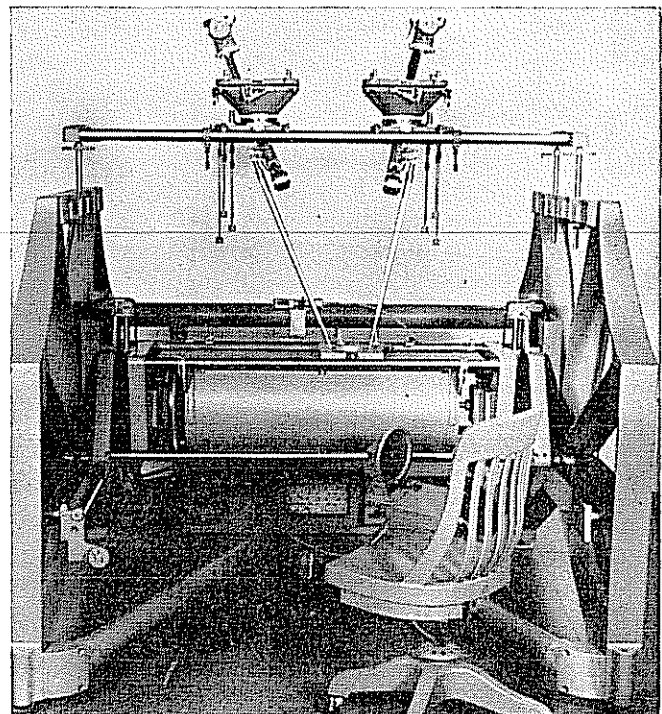

Figure 84. The 1960 Orthophotoscope with Kelsh-type projectors

because of the restrictions imposed by the physical size of the flat film platform, the viewing distance to the rear portions of the stereo-model was excessive.

It is reasonable to expect that the scanning accuracy will be enhanced by the improved viewing conditions and the reduction in operator fatigue. The geometric faithfulness of the resulting orthophotographs is directly dependent upon the scanning accuracy. Where it is intended to use the profile data as hypsometric information, the accuracy of scanning is vitally important.

Another significant innovation is the insertion of self-synchronizing mechanisms in the transmission of x -, y - and z -motions to the scanning assembly.

A constant-speed electric motor is used to power the x -motion of the scanning carriage. This motor rotates a generator selsyn that governs the rotation of a motor selsyn. The reacting motor selsyn turns a lead screw that drives the scanning carriage along its path in the x -direction on the cylinder assembly. At the end of each scanning path the carriage trips an electric switch that activates the set-over mechanism for the synchronized motions in the y -direction.

The z -motion of the cylinder assembly is controlled manually through a handwheel mounted on the operator's chair. The handwheel rotates a generator selsyn that transmits the mechanical rotation of the handwheel electrically, through a flexible cable, to a motor selsyn mounted on the Orthophotoscope. This motor selsyn controls the rotation of a lead screw that provides the z -motion for the cylinder assembly. The scanning operation, which requires that the elevation of the scanning aperture be adjusted continually to remain in contact with the surface of the stereomodel, is facilitated by this arrangement. As the operator moves forward slowly to maintain a desirable and nearly constant viewing relationship with the scanning platen, the manual control for the z -adjustment moves with him. Eliminated are

the awkward postures formerly required of the operator as he observed the scanning platen in its various positions throughout the area of the stereomodel and, at the same time, had to reach and make critical adjustments with a manual control located on a stationary mount.

The servomechanical response of the x - and z -motions is positive and extremely smooth and represents a considerable improvement over the mechanical-linkage action of the earlier instruments. However, the primary reason for the incorporation of synchros in the new design is the ability of each generator selsyn to function as a master for more than one motor selsyn. Additional motors, remotely located, can be made to respond to the electric currents induced by the generator selsyns on the Orthophotoscope. In this way the three co-ordinate motions of the scanning carriage can be reproduced or recorded by other instrumentation physically distant from the Orthophotoscope. The profile data of each scan can accordingly be used, simultaneously or subsequently, to operate other image restitution equipment and model carving equipment, and to extract hypsometric information in digital or analogue form.

The importance of the development of practical means for obtaining uniform-scale photographs has been recognized. The Orthophotoscope's compatibility with an applicability in automatic photogrammetric mapping systems may be of still greater significance. Available now from the scanning procedure are records of map-worthy planimetric and hypsometric information in the form of orthophotographs and profile data. At present only the z -component of the profiling exercise is not fully automatic. However, if the development and refinement of electronic sensing devices, such as the Automatic Scanning Correlator, continue at their present rate, it should not be long before the valuable products of the Orthophotoscope are obtained in a completely automatic operation.

ANALYTIC RELATIVE ORIENTATION IN PHOTOGRAMMETRY¹

Technical paper by G. C. Tewinkel, United States Coast and Geodetic Survey

1. INTRODUCTION

This paper relates to computational details encountered in the problem of relative orientation, which is one of several problems involved in analytic photogrammetry—the computational method of determining the position in three dimensions of objects from the measured co-ordinates of their images on photographs.

In general, these details were not included in either of two previous publications². Moreover, some of these details are not dealt with elsewhere. It is hoped that this expression may serve both to reduce some of the mystery of analytic photogrammetry and to prevent others from having to repeat the same derivations.

This paper may also be significant from the standpoint that a technique is employed which enables the iterative solution to converge and at the same time allows the solution to remain small, namely, involving only five

independent unknowns. Certainly, this is no secret, but it has nevertheless not been publicized to my knowledge. This is discussed in section 7.

The major computational task involves the evaluation of fourteen co-efficients of a pair of observation equations (equations 5.1, 5.7, 7.17) associated with each image. This discussion comprises an attempt to show an orderly and efficient routine for determining these values and to justify the operations.

Matrix multiplication is used considerably because it is so brief and meaningful. Advanced matrix operations are not utilized. If the reader is familiar with the simple routine for forming matrix products he should have no difficulty in applying these techniques: therefore, a brief treatment of matrix products is included.

Although the topic of relative orientation of two photographs is considered throughout, the same basic operations

¹ The original text of this paper and those of the following two papers were submitted by the United States of America and appeared together as document E/CONF.36/L.50.

² G. C. Tewinkel, *Mathematical Basis of Analytic Aerotriangulation*, Technical Bulletin No. 8, United States Coast and Geodetic Survey (Washington, D. C., 1959) and "Analytic photogrammetry" *Revista Cartográfica*, v. 8, No. 8 (Buenos Aires).

are involved whether the problem is the resection of a single photograph or the adjustment of an entire strip or block of many overlapping photographs: the same observation equations and fourteen co-efficients are utilized.

The fundamental basis was indicated by von Gruber in 1932³, and was treated extensively by Schmid in 1953⁴ and subsequently.

2. DEFINITION OF A MATRIX PRODUCT

The routine for forming matrix products is presented although the subject is more thoroughly discussed in countless textbooks.

A *matrix* may be defined as any table of numbers, or a portion of the table. The table is considered to be composed of *elements* arranged in *rows* and *columns*. For example, the following is a matrix consisting of three rows and three columns:

$$A = \begin{bmatrix} a & b & c \\ d & e & f \\ g & h & i \end{bmatrix} \quad (2.1)$$

A special matrix consisting of a single row or single column may be called a *vector*; for example:

$$(x \ y \ z) \quad \text{or} \quad \begin{bmatrix} x \\ y \\ z \end{bmatrix}$$

The product of this vector with a matrix is *defined* as follows:

$$\begin{bmatrix} a & b & c \\ d & e & f \\ g & h & i \end{bmatrix} \begin{bmatrix} x \\ y \\ z \end{bmatrix} = \begin{bmatrix} ax + by + cz \\ dx + ey + fz \\ gx + hy + iz \end{bmatrix} \quad (2.2)$$

or $AB = C$

where the right-hand term is another matrix (vector) consisting of a column of three values obtained as indicated. The orderliness of the products is apparent, especially if one traces out the combinations of terms with his fingers.

Mathematicians usually prefer a subscript notation such as a_{ij} in which i indicates the number of the row and j the number of the column in which the element a lies. Thus, the previous matrix and vector product might have been written

$$\begin{bmatrix} a_{11} & a_{12} & a_{13} \\ a_{21} & a_{22} & a_{23} \\ a_{31} & a_{32} & a_{33} \end{bmatrix} \begin{bmatrix} x_1 \\ x_2 \\ x_3 \end{bmatrix} = \begin{bmatrix} a_{11}x_1 + a_{12}x_2 + a_{13}x_3 \\ a_{21}x_1 + a_{22}x_2 + a_{23}x_3 \\ a_{31}x_1 + a_{32}x_2 + a_{33}x_3 \end{bmatrix} \quad (2.3)$$

and a single element of the product might have been symbolized as

$$X_{ij} = \sum_{j=1}^3 a_{ij} x_j$$

meaning that an element X_i in row i of the product is equal to the summation of the products of the a_{ij} terms of the matrix and the x_j terms of the vector. In programming, it is convenient to indicate the operation as

$$X_i = X_i + a_{ij} X_j$$

which means that the product is added to what accumulated beforehand, proper operating limits having been established.

If this definition is applied to other than vectors, the definition becomes only an extension of the previous definition:

$$\begin{bmatrix} a & b & c \\ d & e & f \\ g & h & i \end{bmatrix} \begin{bmatrix} j & k & l \\ m & n & o \\ p & q & r \end{bmatrix} = \begin{bmatrix} aj + bm + cp & ak + bn + cq & al + bo + cr \\ dj + em + fp & dk + en + fg & dl + eo + fr \\ gj + hm + ip & gk + hn + ig & gl + ho + ir \end{bmatrix} \quad (2.4)$$

in which the latter is also a matrix of nine values arranged in the form of three rows and three columns. If subscripts are used, then the product may be stated as

$$(a_{ij})(b_{jk}) = (\sum a_{ik} b_{kj}) \quad (2.5)$$

A rule is observed in the use of matrix products which states that the number of rows of the second matrix must be equal to the number of columns of the first.

It is important that a product formed in reverse order is generally different from that of the original order. The first example may be stated in reverse order wherein the vector is indicated as a row vector:

$$(x \ y \ z) \begin{bmatrix} a & b & c \\ d & e & f \\ g & h & i \end{bmatrix} =$$

$$(ax + dy + gz, \ bx + ey + hz, \ cx + fy + iz)$$

which indicates a different result

Herein, a bold face letter is used to represent an entire matrix, such as A in equation 2.1. Then $AB = C$ is used to mean the product of two matrices resulting in a matrix C . Only by context is the character of each individual matrix apparent inasmuch as A , B or C may be a single-row (or column) vector, or a square or rectangular shape. For example, $AB = C$ may apply equally well to indicate the operations involved in equations 2.2, 2.3 or 2.4. However, as mentioned before, the order of multiplication is important: AB and BA are generally not identical.

We shall also find occasion to use the notation dA/dx to mean the derivative of each of the elements of A where x is considered to be the variable. The term $(\partial A/\partial w)B$ is used to mean the product of two matrices, the first of which is composed of the partial derivatives of the elements of the A -matrix relative to the variable w . In equation 4.3c, B is defined as a particular column matrix. Then in equation 7.6, C in CA is a row matrix. Moreover, A_1 is defined herein to mean the first row matrix of the larger A -matrix.

Occasionally an uninitiated reader is confused by the two terms "matrix" and "determinant". A determinant is a *number* which may be evaluated from a square matrix. We say "the determinant of a matrix". One may or may not be interested in the determinant of a matrix. A determinant is symbolized by straight lines

$$D = \begin{vmatrix} a & b & c \\ d & e & f \\ g & h & i \end{vmatrix}$$

whereas a matrix is symbolized by curved lines, like parentheses, or by brackets

$$A = \begin{pmatrix} a & b & c \\ d & e & f \\ g & h & i \end{pmatrix} = \left[\begin{array}{ccc} a & b & c \\ d & e & f \\ g & h & i \end{array} \right]$$

³ O. Van Gruber, *Photogrammetry, Collected Lectures and Essays* (London, Chapman and Hall, 1932), page 13 ff.

⁴ H. H. Schmid, "An analytical treatment of a photogrammetric camera", Report No. 880, Ballistic Research Laboratories, Aberdeen Proving Ground, Maryland, 1953.

3. THE ROTATION MATRIX

This topic is discussed in *Bulletin 8* using the angular designations a, b, c . Here instead, the Greek photogrammetric symbols are used: $\omega = a, \varphi = b, \varkappa = c$

$$\begin{aligned} a_{11} &= \cos \varphi \cos \varkappa \\ a_{21} &= -\cos \varphi \sin \varkappa \\ a_{31} &= \sin \varphi \end{aligned}$$

$$\begin{aligned} a_{12} &= \sin \omega \sin \varkappa - \cos \omega \sin \varphi \cos \varkappa \\ a_{22} &= \sin \omega \cos \varkappa + \cos \omega \sin \varphi \sin \varkappa \\ a_{32} &= \cos \omega \cos \varphi \end{aligned}$$

$$\begin{bmatrix} a_{11} & a_{12} & a_{13} \\ a_{21} & a_{22} & a_{23} \\ a_{31} & a_{32} & a_{33} \end{bmatrix} = \begin{bmatrix} \cos \varkappa & \sin \varkappa & 0 \\ -\sin \varkappa & \cos \varkappa & 0 \\ 0 & 0 & 1 \end{bmatrix} \begin{bmatrix} \cos \varphi & 0 & -\sin \varphi \\ 0 & 1 & 0 \\ \sin \varphi & 0 & \cos \varphi \end{bmatrix} \begin{bmatrix} 1 & 0 & 0 \\ 0 & \cos \omega & \sin \omega \\ 0 & -\sin \omega & \cos \omega \end{bmatrix} \quad (3.1)$$

which also discloses probably the most convenient method for forming the values of the a terms on an electronic computer. This is shown specifically in section 8 wherein the resulting matrix appears in a large table designated as

$$\begin{bmatrix} a_{18,1} & a_{18,2} & a_{18,3} \\ a_{19,1} & a_{19,2} & a_{19,3} \\ a_{20,1} & a_{20,2} & a_{20,3} \end{bmatrix} \quad (3.2)$$

This matrix allows one to transform (rectify) co-ordinate values measured on a tilted photograph, and vice versa:

$$\begin{aligned} x &= x^* \cos \theta_{11} + y^* \cos \theta_{12} + z^* \cos \theta_{13} \\ y &= x^* \cos \theta_{21} + y^* \cos \theta_{22} + z^* \cos \theta_{23} \\ z &= x^* \cos \theta_{31} + y^* \cos \theta_{32} + z^* \cos \theta_{33} \end{aligned}$$

If the letter a is used to designate the term $\cos \theta$, and the matrix notation applied,

$$\begin{bmatrix} x \\ y \\ z \end{bmatrix} = \begin{bmatrix} a_{11} & a_{12} & a_{13} \\ a_{21} & a_{22} & a_{23} \\ a_{31} & a_{32} & a_{33} \end{bmatrix} \begin{bmatrix} x^* \\ y^* \\ z^* \end{bmatrix} \quad (3.3)$$

$$\begin{bmatrix} x^* \\ y^* \\ z^* \end{bmatrix} = \begin{bmatrix} a_{11} & a_{21} & a_{31} \\ a_{12} & a_{22} & a_{32} \\ a_{13} & a_{23} & a_{33} \end{bmatrix} \begin{bmatrix} x \\ y \\ z \end{bmatrix} \quad (3.4)$$

where the asterisk (*) indicates the "rectified" values. These ideas might also have been stated: $X = AX^*$ and $X^* = A^T X$ where A^T is called "A-transpose".

One method for forming the matrix product indicated in equation 3.1 is first to form the intermediate product of the second two matrices, and then to form the product of the first matrix with the intermediate matrix. The intermediate product matrix is:

$$\begin{bmatrix} \cos \varphi & 0 & -\sin \varphi \\ 0 & 1 & 0 \\ \sin \varphi & 0 & \cos \varphi \end{bmatrix} \begin{bmatrix} 1 & 0 & 0 \\ 0 & \cos \omega & \sin \omega \\ 0 & -\sin \omega & \cos \omega \end{bmatrix} = \begin{bmatrix} \cos \varphi & \sin \omega \sin \varphi & -\cos \omega \sin \varphi \\ 0 & \cos \omega & \sin \omega \\ \sin \varphi & -\sin \omega \cos \varphi & \cos \omega \cos \varphi \end{bmatrix} \quad (3.5)$$

The next operation then obtains the complete rotation matrix in terms of $\omega, \varphi, \varkappa$:

$$A = \begin{bmatrix} a_{11} & a_{12} & a_{13} \\ a_{21} & a_{22} & a_{23} \\ a_{31} & a_{32} & a_{33} \end{bmatrix} = \begin{bmatrix} \cos \varphi \cos \varkappa & \cos \omega \sin \varkappa & \sin \omega \sin \varkappa \\ -\cos \varphi \sin \varkappa & \sin \omega \sin \varphi \cos \varkappa & -\cos \omega \sin \varphi \cos \varkappa \\ \sin \varphi & -\sin \omega \sin \varphi \sin \varkappa & +\cos \omega \sin \varphi \sin \varkappa \\ \sin \varphi & -\sin \omega \cos \varphi & \cos \omega \cos \varphi \end{bmatrix} \quad (3.6)$$

Later it will be convenient to use A_1 to mean the row (vector) of three elements (a_{11}, a_{12}, a_{13}), etc.

(omega, phi and kappa). Otherwise, the geometry is identical.

Rosenfield has shown⁵ that the resultant three-space rotation matrix is formed by the matrix product of the three sequential plane rotations (like Euler rotations):

$$\begin{aligned} a_{12} &= \cos \omega \sin \varkappa + \sin \omega \sin \varphi \cos \varkappa \\ a_{22} &= \cos \omega \cos \varkappa - \sin \omega \sin \varphi \sin \varkappa \\ a_{32} &= -\sin \omega \cos \varphi \end{aligned}$$

4. THE BASIC PROJECTIVE TRANSFORMATION

The derivation contained in *Bulletin 8* is repeated here.

Figure 85 shows the geometric relationships where x^* and z^* are rectified co-ordinates, and y^* is analogous to x^* upon viewing the situation from the side. X, Y, Z and X_0, Y_0, Z_0 are co-ordinates based on a reference (geodetic) earth system. From similar right triangles, the proportions of corresponding sides may be expressed as

$$\begin{aligned} x^* / z^* &= (X - X_0) / (Z - Z_0) \\ y^* / z^* &= (Y - Y_0) / (Z - Z_0) \end{aligned}$$

Solving for x^* and y^* , and writing z^* as an identity:

$$\begin{aligned} x^* &= (X - X_0) z^* / (Z - Z_0) \\ y^* &= (Y - Y_0) z^* / (Z - Z_0) \\ z^* &= (Z - Z_0) z^* / (Z - Z_0) \end{aligned} \quad (4.1)$$

The expansion of the rotation matrix equation 3.4, may be expressed as

$$\begin{aligned} x &= a_{11} x^* + a_{12} y^* + a_{13} z^* \\ y &= a_{21} x^* + a_{22} y^* + a_{23} z^* \\ z &= a_{31} x^* + a_{32} y^* + a_{33} z^* \end{aligned} \quad (4.2)$$

To collapse several operations, equations 4.1 are substituted into 4.2; then, in 4.2, x is divided by z , and y is divided by z , giving the two equations

$$\begin{aligned} \frac{x}{z} &= \frac{(X - X_0) a_{11} + (Y - Y_0) a_{12} + (Z - Z_0) a_{13}}{(X - X_0) a_{31} + (Y - Y_0) a_{32} + (Z - Z_0) a_{33}} \\ \frac{y}{z} &= \frac{(X - X_0) a_{21} + (Y - Y_0) a_{22} + (Z - Z_0) a_{23}}{(X - X_0) a_{31} + (Y - Y_0) a_{32} + (Z - Z_0) a_{33}} \end{aligned} \quad (4.3a)$$

which, upon clearing of fractions and substituting the elementary rotation angles $\omega, \varphi, \varkappa$ for the a 's, become the equivalent expressions

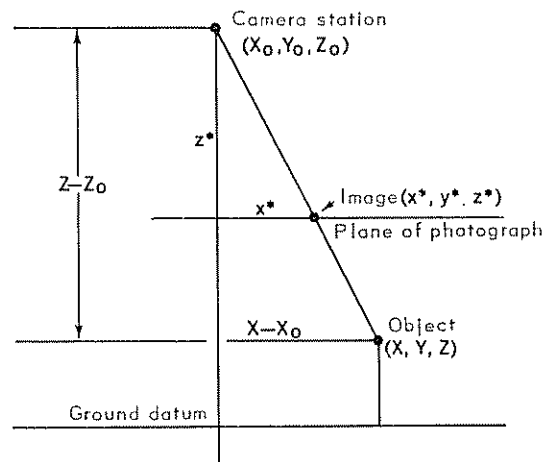

Figure 85. Diagram showing the geometric relationships used in the basic projective transformation

⁵ George H. Rosenfield, "The problem of exterior orientation in photogrammetry", *Photogrammetric Engineering*, v. XXV, No. 4, September 1959, page 536.

$$\begin{aligned}
x [(X - X_0) \sin \varphi + (Y - Y_0) (-\sin \omega \cos \varphi) + (Z - Z_0) \cos \omega \cos \varphi] \\
- z [(X - X_0) \cos \varphi \cos \varkappa \\
+ (Y - Y_0) (\cos \omega \sin \varkappa + \sin \omega \sin \varphi \cos \varkappa) \\
+ (Z - Z_0) (\sin \omega \sin \varkappa - \cos \omega \sin \varphi \cos \varkappa)] = 0 \\
y [(X - X_0) \sin \varphi + (Y - Y_0) (-\sin \omega \cos \varphi) + (Z - Z_0) \cos \omega \cos \varphi] \\
- z [(X - X_0) (-\cos \varphi \sin \varkappa) \\
+ (Y - Y_0) (\cos \omega \cos \varkappa - \sin \omega \sin \varphi \sin \varkappa) \\
+ (Z - Z_0) (\sin \omega \cos \varkappa + \cos \omega \sin \varphi \sin \varkappa)] = 0.
\end{aligned} \tag{4.3 b}$$

For later reference, equations 4.3a are also expressed in matrix notation. If

$$\mathbf{A}_1 = (a_{11} \ a_{12} \ a_{13}), \text{ etc.}, \text{ and } \mathbf{B} = \begin{bmatrix} X - X_0 \\ Y - Y_0 \\ Z - Z_0 \end{bmatrix}, \text{ then}$$

$$x/z = \mathbf{A}_1 \mathbf{B} / \mathbf{A}_3 \mathbf{B}, \quad y/z = \mathbf{A}_2 \mathbf{B} / \mathbf{A}_3 \mathbf{B} \tag{4.3 c}$$

which can be expressed in determinant form:

$$\begin{vmatrix} x & z \\ \mathbf{A}_1 \mathbf{B} & \mathbf{A}_3 \mathbf{B} \end{vmatrix} = 0 \quad \text{and} \quad \begin{vmatrix} y & z \\ \mathbf{A}_2 \mathbf{B} & \mathbf{A}_3 \mathbf{B} \end{vmatrix} = 0. \tag{4.3 d}$$

This pair of equations expresses the condition upon which this entire analytical photogrammetric system is based. These are the equations of a line on which lie three points—a ground object, a camera station and the image. These equations define a projective transformation.

It is noted that z represents the camera focal length which may be considered as a constant; that x and y are observed values; and the $X, Y, Z, X_0, Y_0, Z_0, \omega, \varphi, \varkappa$ are nine unknowns, the last six of which remain constant for all the images on a given photograph, but the first three of which differ for each image.

The problem is to find appropriate values for the unknowns such that the equations are satisfied for all image-lens-object colineations involved in all overlapping photographs simultaneously. To do this, in place of utilizing equations 3 in a direct procedure, approximate values are tried, corrections are computed and applied iteratively until no further corrections are significant. Many images are made use of, and a least squares solution is applied so as to minimize corrections v_x and v_y to the

observed co-ordinates x and y in order to enforce all the colineations implied by the equations.

Equations 3 become both ideal and relatively simple inasmuch as *only one observed quantity appears in each equation.*

5. THE OBSERVATION EQUATIONS

In this procedure of analytic photogrammetry, a set of simultaneous linear observation equations is formed and solved for incremental corrections to approximated parameters. The formation of the coefficients of these equations constitutes the salient operation wherein the basic photogrammetric principles are applied. The coefficients are computed using formulas which are derived from equations 4.3 (perspective colineation) through the use of elementary rules of partial differential calculus. We shall now derive these formulas using determinant and matrix notation so as to indicate as vividly as possible the orderliness of the formulas.

To be more specific, the observation equations are of the form

$$\begin{aligned}
v_x &= p_{11} + p_{12}d\omega + p_{13}d\varphi + p_{14}d\varkappa - p_{15}dX_0 - p_{16}dY_0 - p_{17}dZ_0 + p_{18}dX + p_{19}dY + p_{17}dZ \\
v_y &= p_{21} + p_{22}d\omega + p_{23}d\varphi + p_{24}d\varkappa - p_{25}dX_0 - p_{26}dY_0 - p_{27}dZ_0 + p_{28}dX + p_{29}dY + p_{27}dZ
\end{aligned} \tag{5.1}$$

where two equations arise from each image utilized on each of two overlapping photographs. (See also equation 7.17.) We are considering the formulas for the computation of the fourteen terms $p_{11} \dots p_{27}$

Equations 4.3c are recalled

$$\begin{vmatrix} x & z \\ \mathbf{A}_1 \mathbf{B} & \mathbf{A}_3 \mathbf{B} \end{vmatrix} = 0, \quad \begin{vmatrix} y & z \\ \mathbf{A}_2 \mathbf{B} & \mathbf{A}_3 \mathbf{B} \end{vmatrix} = 0 \tag{5.2}$$

The term z is considered to be a constant—the focal length of the aerial camera, regarded as negative (minus) or downward. Although x and y are observed quantities, they too are considered as variables in the sense that they are subject to adjustment for small random uncorrectable errors which may and do persist from many known and unknown sources. The \mathbf{A} -terms contain the three angles $\omega, \varphi, \varkappa$, all of which are variables. Also the \mathbf{B} -terms contain the six variables, the X, Y, Z co-ordinates of an object point on the ground, and the X_0, Y_0, Z_0 co-ordinates of the camera lens at the moment of exposure.

If all the variables have correct values, equations 5.2 are satisfied. If the values are not correct, this condition is indicated by the fact that these determinants are *not*

equal to zero, in which case we wish to determine incremental corrections to the ten variables so as to regain the zero value. Let F_x and F_y be the non-zero values. Using only the first equation for the time being

$$F = \begin{vmatrix} x & z \\ \mathbf{A}_1 \mathbf{B} & \mathbf{A}_3 \mathbf{B} \end{vmatrix}. \tag{5.3}$$

Inasmuch as F ought to be zero, we wish to create a change- ΔF . Moreover, because of the fact that it is always possible to approximate the ten parameters very closely, F is relatively small, whereupon it can be considered as an incremental change dF in the sense of calculus. Differentiating both sides of 5.3,

$$-dF = \frac{\partial F}{\partial x} dx + \frac{\partial F}{\partial \omega} d\omega + \dots + \frac{\partial F}{\partial X_0} dX_0 +$$

which begins to resemble 5.1. If this is now solved for dx , using the residual notation v_x to mean the same as dx , and noting that dF is none other than F ,

$$-\frac{\partial F}{\partial x} v_x = F + \frac{\partial F}{\partial \omega} d\omega + \dots + \frac{\partial F}{\partial X_0} dX_0$$

Inasmuch as (1) the v_x and v_y coefficients are equal to $-\delta F/\delta x$, and (2) the numerical value of this term is approximately equal in practice for all images, the term can be neglected entirely. It does mean, however, that the value of v_x will appear to be much larger than one would expect, by the photo scale factor, and also to be of opposite algebraic sign, neither of which is of any significance. Consequently, this form of equation 5.1 is established.

Obviously, the terms $\delta F/\delta x$, $\delta F/\delta \omega$, ... $\delta F/\delta Z_0$ need to be evaluated. Utilizing the calculus,

$$\frac{\delta F}{\delta X} = \frac{\delta}{\delta x} \begin{vmatrix} x & z \\ A_1 B & A_3 B \end{vmatrix} = \begin{vmatrix} 1 & 0 \\ A_1 B & A_3 B \end{vmatrix} = A_3 B$$

For the term $\delta F/\delta \omega$, the variable ω occurs only in the A_1 and A_3 terms, or

$$\frac{\delta A}{\delta \omega} = \begin{bmatrix} 0 & -\sin \omega \sin \kappa & \cos \omega \sin \kappa \\ +\cos \omega \sin \varphi \cos \kappa & +\sin \omega \sin \varphi \cos \kappa & \\ 0 & -\sin \omega \cos \kappa & \cos \omega \cos \kappa \\ -\cos \omega \sin \varphi \sin \kappa & -\sin \omega \sin \varphi \sin \kappa & \\ 0 & -\cos \omega \cos \varphi & -\sin \omega \cos \varphi \end{bmatrix} = \begin{bmatrix} 0 & -a_{13} & a_{12} \\ 0 & -a_{23} & a_{22} \\ 0 & -a_{33} & a_{32} \end{bmatrix} \quad (5.4)$$

It is evident that $\delta A/\delta \omega$ is formed directly from A by simply a transfer of numbers without any further computation. Also,

$$\frac{\delta A}{\delta \varphi} = \begin{bmatrix} -\sin \varphi \cos \kappa & \sin \omega \cos \varphi \cos \kappa & -\cos \omega \cos \varphi \cos \kappa \\ \sin \varphi \sin \kappa & -\sin \omega \cos \varphi \sin \kappa & \cos \omega \cos \varphi \sin \kappa \\ \cos \varphi & \sin \omega \sin \varphi & -\cos \omega \sin \varphi \end{bmatrix} \quad (5.5)$$

This does not seem as simple as 5.4, but it is noteworthy that equation 3.5, the intermediate matrix product, bears significant resemblance. The third row of 5.5 is identical to the first row of 3.5; the elements of the first row of 5.5

are the products of the corresponding elements of the third row of 3.5 times ($-\cos \kappa$); and the elements of the second row 5.5 are the products of the corresponding elements of the third row of 3.5 times ($+\sin \kappa$). Next,

$$\frac{\delta A}{\delta \kappa} = \begin{bmatrix} -\cos \varphi \sin \kappa & \cos \omega \cos \kappa & \sin \omega \cos \kappa \\ -\cos \varphi \cos \kappa & -\sin \omega \sin \varphi \sin \kappa & +\cos \omega \sin \varphi \sin \kappa \\ 0 & -\sin \omega \sin \varphi \cos \kappa & +\cos \omega \sin \varphi \cos \kappa \end{bmatrix} = \begin{bmatrix} a_{21} & a_{22} & a_{23} \\ -a_{11} & -a_{12} & -a_{13} \\ 0 & 0 & 0 \end{bmatrix} \quad (5.6)$$

Thus we have seen how one can compute numerically the values of all the 36 elements, including the A -matrix (in section 3), and now all its partial derivatives. Moreover, based on the definitions leading to equation 4.3c, all the AB -matrix products and all the derivative

forms can be numerically computed and stored in preparation for the following equations, where it is noted that p_{11} is none other than F given by 5.2 and 5.3 (see equation 5.1):

$$\begin{aligned} p_{11} &= \begin{vmatrix} x & z \\ A_1 B & A_3 B \end{vmatrix} & p_{21} &= \begin{vmatrix} y & z \\ A_2 B & A_3 B \end{vmatrix} \\ p_{12} &= \begin{vmatrix} x & z \\ \frac{\delta A_1}{\delta \omega} B & \frac{\delta A_3}{\delta \omega} B \end{vmatrix} & p_{22} &= \begin{vmatrix} y & z \\ \frac{\delta A_2}{\delta \omega} B & \frac{\delta A_3}{\delta \omega} B \end{vmatrix} \\ p_{13} &= \begin{vmatrix} x & z \\ \frac{\delta A_1}{\delta \varphi} B & \frac{\delta A_3}{\delta \varphi} B \end{vmatrix} & p_{23} &= \begin{vmatrix} y & z \\ \frac{\delta A_2}{\delta \varphi} B & \frac{\delta A_3}{\delta \varphi} B \end{vmatrix} \\ p_{14} &= \begin{vmatrix} x & z \\ \frac{\delta A_1}{\delta \kappa} B & \frac{\delta A_3}{\delta \kappa} B \end{vmatrix} & p_{24} &= \begin{vmatrix} y & z \\ \frac{\delta A_2}{\delta \kappa} B & \frac{\delta A_3}{\delta \kappa} B \end{vmatrix} \\ p_{15} &= \begin{vmatrix} x & z \\ a_{11} & a_{31} \end{vmatrix} & p_{25} &= \begin{vmatrix} y & z \\ a_{21} & a_{31} \end{vmatrix} \\ p_{16} &= \begin{vmatrix} x & z \\ a_{12} & a_{32} \end{vmatrix} & p_{26} &= \begin{vmatrix} y & z \\ a_{22} & a_{32} \end{vmatrix} \\ p_{17} &= \begin{vmatrix} x & z \\ a_{13} & a_{33} \end{vmatrix} & p_{27} &= \begin{vmatrix} y & z \\ a_{23} & a_{33} \end{vmatrix} \end{aligned} \quad (5.7)$$

However, these are only preliminary values of the coefficients. The next section derives corrections so that the X, Y, Z object co-ordinates terms in equation 5.1 can be eliminated (equation 7.17).

6. MODEL CO-ORDINATES

In conventional photogrammetry, a three-dimensional model of a portion of the earth is represented by the common area of two overlapping photographs. Two such photographs can be viewed with a stereoscope whereupon one visually perceives a 3-D earth replica in surprisingly realistic, if not exotic form. The analytic model co-ordinates comprise computed three-dimensional co-ordinate values of model points corresponding to pairs of images, one from each photograph. Consequently, "model" implies two photographs. By "relative orientation" is meant the orientation of one photograph relative to an overlapping one.

The following equation was derived in *Bulletin 8* for the elevation Z of an "object" in a model:

$$Z = \frac{(X_0'' - X_0') z^{*'} z^{*''} + Z_0' x^{*'} z^{*''} - Z_0'' x^{*''} z^{*'}}{x^{*'} z^{*''} - x^{*''} z^{*'}}$$

in which the single and double primes refer to the first and second photographs and the asterisks refer to rectified co-ordinates.

In relative orientation it is appropriate to regard the first photograph as untilted ($\omega = \varphi = \kappa = 0$) whereupon the rectified co-ordinates are equal respectively to the observed co-ordinates so the $x^{*'}$ and $z^{*'}$ can be replaced simply by x and z . Also it is convenient to regard the first camera station to be at the origin of the earth system, or $X_0' = Z_0' = 0$. It is also permissible to assign any constant value whatsoever to X_0'' (air base), whence $X_0'' = 1$. Thus the equation for Z can be reduced to

$$Z = \frac{Z_0 x^* - z^*}{x^* - (x/z) z^*}$$

where the starred (*) terms are rectified image co-ordinates from the second photograph and x and y are unrectified co-ordinates of the corresponding image on the first photograph.

This allows (1) an approximate Z to be computed for each model point in terms of the four other approximate parameters $Z_0, \omega, \varphi, \kappa$, and the observed image co-ordinates; and (2) the other two horizontal co-ordinates X, Y of the object to be evaluated. Upon subsequent iterative modifications of the approximations, Z, X and Y eventually become valid model co-ordinates.

Once Z is determined, the X and Y model co-ordinates can be determined by virtue of the similar right triangles used in developing the projective transformation (equation 4.1), and based on image co-ordinates of the first photograph:

$$X = (x/z) Z; \quad Y = (y/z) Z \quad (6.3)$$

Four auxiliary u -values are defined, based on equations 6.2 and 6.3:

$$u_3 = x/z; \quad u_4 = y/z; \quad u_1 = \frac{Z_0 x^* - z^*}{x^* - u_3 z^*} \quad (\text{numerator}) \\ u_2 = \frac{x^* - u_3 z^*}{x^* - u_3 z^*} \quad (\text{denominator}) \quad (6.4)$$

Then,

$$Z = u_1/u_2, \quad X = u_3 Z, \quad Y = u_4 Z \quad (6.5)$$

7. ELIMINATION OF THE MODEL CO-ORDINATE TERMS

The two observation equations 5.1 each contain three terms in dX, dY, dZ , corrections to the approximate model co-ordinates. These cannot be dealt with very well because of the increase in the number of unknowns with each added image. However, equations 6.2 and 6.3 now allow these terms to be expressed in terms of other terms $\omega, \varphi, \kappa, Z_0$. Inasmuch as this topic is not considered in *Bulletin 8*, it is derived here in detail. Moreover it was purposely omitted from initial computations with the idea that the terms were insignificant, but, as a result, the iterative solution failed to converge: their inclusion restored convergence.

Equation 6.2 is written to include the term u_3 :

$$Z = \frac{Z_0 x^* - z^*}{x^* - u_3 z^*} = \frac{u_1}{u_2} \quad (7.1)$$

From the calculus,

$$dZ = \frac{u_2 du_1 - u_1 du_2}{u_2^2} = (1/u_2) (du_1 - Z du_2), \quad (7.2)$$

recognizing that $u_1/u_2 = Z$. But

$$du_1 = d(Z_0 x^* - z^*) = x^* dZ_0 + Z_0 dx^* - dz^* \quad (7.3)$$

$$du_2 = d(x^* - u_3 z^*) = dx^* - u_3 dz^* \quad (7.4)$$

Substituting 7.3 and 7.4 into 7.2, and noting that $u_3 Z = X$,

$$dZ = (1/u_2) x^* dZ_0 - (Z - Z_0) dx^* + (X - 1) dz^* \quad (7.5)$$

Recalling that x^* and z^* are rectified co-ordinates, we need to express dx^* and dz^* in terms of the angles ω, φ and κ . From equation 3.4, the rectified co-ordinates can be expressed in terms of the observed co-ordinates:

$$x^* = (x_2 \ y_2 \ z_2) \begin{bmatrix} a_{11} \\ a_{21} \\ a_{31} \end{bmatrix} \quad (= C A_1)$$

$$z^* = (x_2 \ y_2 \ z_2) \begin{bmatrix} a_{12} \\ a_{22} \\ a_{32} \end{bmatrix} \quad (= C A_2)$$

where the subscript in x_2 refers to the image co-ordinate on the second photograph. The y^* -term is not needed. More generally,

$$(x^* \ y^* \ z^*) = (x_2 \ y_2 \ z_2) \begin{bmatrix} a_{11} & a_{12} & a_{13} \\ a_{21} & a_{22} & a_{23} \\ a_{31} & a_{32} & a_{33} \end{bmatrix} \quad (= C A)$$

Using the abbreviated notation,

$$dx^* = C \delta A_1 / \delta \omega d\omega + C \delta A_1 / \delta \varphi d\varphi + C \delta A_1 / \delta \kappa d\kappa \\ dz^* = C \delta A_2 / \delta \omega d\omega + C \delta A_2 / \delta \varphi d\varphi + C \delta A_2 / \delta \kappa d\kappa \quad (7.8)$$

Substituting 7.8 into 7.5,

$$dZ = (1/u_2) x^* dZ_0 \\ + [- (Z - Z_0) C \delta A_1 / \delta \omega + (X - 1) C \delta A_2 / \delta \omega] d\omega \\ + [- (Z - Z_0) C \delta A_1 / \delta \varphi + (X - 1) C \delta A_2 / \delta \varphi] d\varphi \\ + [- (Z - Z_0) C \delta A_1 / \delta \kappa + (X - 1) C \delta A_2 / \delta \kappa] d\kappa \quad (7.9)$$

If the bracketed terms are expressed as determinants,

$$dZ = (1/u_2) \left\{ x^* dZ_0 \right. \\ + \left. \begin{vmatrix} X - 1 & Z - Z_0 \\ C \delta A_1 / \delta \omega & C \delta A_2 / \delta \omega \end{vmatrix} d\omega \right. \\ + \left. \begin{vmatrix} X - 1 & Z - Z_0 \\ C \delta A_1 / \delta \varphi & C \delta A_2 / \delta \varphi \end{vmatrix} d\varphi \right. \\ + \left. \begin{vmatrix} X - 1 & Z - Z_0 \\ C \delta A_1 / \delta \kappa & C \delta A_2 / \delta \kappa \end{vmatrix} d\kappa \right\} \quad (7.10)$$

The letter T is now used to symbolize the determinants:

$$dZ = (1/u_2) (T_2 d\omega + T_3 d\phi + T_4 dx + T_7 dZ_0) \quad (7.11)$$

in which the subscripts refer to the corresponding subscripts of p in equation 5.1. But

$$dX = u_3 dZ \quad \text{and} \quad dY = u_4 dZ. \quad (7.12)$$

The model co-ordinate terms in equation 5.1 are

$$\dots + p_{15} dX + p_{16} dY + p_{17} dZ \\ \dots + p_{25} dX + p_{26} dY + p_{27} dZ \quad (7.13)$$

$$p_{15} dX + p_{16} dY + p_{17} dZ = S_1 T_2 d\omega + S_1 T_3 d\phi + S_1 T_4 dx + S_1 T_7 dZ_0 \\ p_{25} dX + p_{26} dY + p_{27} dZ = S_2 T_2 d\omega + S_2 T_3 d\phi + S_2 T_4 dx + S_2 T_7 dZ_0 \quad (7.16)$$

Then if 7.16 is substituted into 5.1, noting that in relative orientation $dX_0 = 0$,

$$v_x + p_{11} + (p_{12} + S_1 T_2) d\omega + (p_{13} + S_1 T_3) d\phi + (p_{14} + S_1 T_4) dx - p_{10} dY_0 - (p_{17} - S_1 T_7) dZ_0 \\ v_y + p_{21} + (p_{22} + S_2 T_2) d\omega + (p_{23} + S_2 T_3) d\phi + (p_{24} + S_2 T_4) dx - p_{20} dY_0 - (p_{27} - S_2 T_7) dZ_0 \quad (7.17)$$

It is noted that in equation 7.10, each of the terms like $c \delta A_1 / \mu \omega$ can be computed and stored inasmuch as $\delta A_1 / \delta \omega$ represents the three terms in the third column of equation 5.4 which are already evaluated.

This completes the derivation of the formulas for the coefficients of the observation equations. A routine for their evaluation has also been suggested.

8. PROCEDURE FOR FORMING COEFFICIENTS FOR THE OBSERVATION EQUATIONS

This procedure is specific, brief and offers no explanations. To organize the presentation, it is considered that five tables of values are formed as indicated in figure 86. The tables are designated A, U, P, T, S . The tabular values are determined in the order:

- A_1 to A_{33}
- U
- A_{34} to A_{39}
- P (preliminary)
- T
- S
- P (final)

The P 's are the wanted coefficients. However, preliminary values are first determined (equation 5.7), after which some of them are corrected, which completes the procedure. Subsequent steps, not included in this paper, solve the set of simultaneous equations and modify the approximations for a further iteration. A step is also required for terminating the iterations. After termination, the read-out data consist of a set of model co-ordinates for each image (row A_{34}), the orientations matrix (rows $A_{19}, 10, 20$), and a list of residuals (P_{11}, P_{21}).

The procedure follows.

1. The given data (table A, rows 1, 2, 3, 4 on page 223) consist of the image co-ordinates of corresponding images on the two photographs where the third z -co-ordinates of the camera station ($X_0 = 1$ irrevocably; $Y_0 = Z_0 = 0$ subject to modification); and the three sines of the elements (row 4) of the angular orientation of the camera (ordinarily these will all be zeros initially and will be modified through the course of the computation; if one or more of them is estimated to be different from zero, then the sine of the estimated angle is entered).

2. Row 5 consists of the cosines of the angles whose sines appear in the previous row. The cosines are computed using the familiar trigonometric relationship $\cos \theta = (1 - \sin^2 \theta)^{1/2}$.

3. Rows 6 through 14 are formed by transferring the appropriate elements of rows 4 and 5. It is probably expedient to load the entire balance of the table with

Substituting 7.12 into 7.13,

$$\dots + (p_{15} u_3 + p_{16} u_4 + p_{17}) dZ \\ \dots + (p_{25} u_3 + p_{26} u_4 + p_{27}) dZ \quad (7.14)$$

If S is defined as

$$S_1 = (1/u_2) (p_{15} u_3 + p_{16} u_4 + p_{17}) \\ S_2 = (1/u_2) (p_{25} u_3 + p_{26} u_4 + p_{27}), \quad (7.15)$$

and if 7.11, 7.14 and 7.15 are substituted into 7.13,

zeros to begin with, and then to load the ones in rows 6, 10 and 14. (Compare equation 3.1.)

4. Rows 15, 16 and 17 consist of the ϕ - ω intermediate matrix product (equation 3.5) of the matrix of rows 9, 10 and 11 and of rows 6, 7 and 8. Equation 2.4 is the formula needed in this operation, which can be programmed as follows in Fortran notation:

```

27   IA = 15
28   IB = 17
29   IC = 3
30 5  D0 6 I = IA, IB
31   D0 6 J = I, 3
32   D0 6 K = 1, 3
33   L = K + IC
34   M = I - 6
35 6  A (I, J) = A (I, J) + A (M, K)*A (L, J)

```

Other steps may also be included in order to use this same formula for subsequent matrix products by changing the limiting values and indices.

5. Rows 18, 19 and 20 (the primary rotation matrix) are formed by the matrix product of the κ -matrix times the intermediate ϕ - ω -matrix (equation 3.1), using the same modifying formula programmed for the intermediate matrix by modifying the values of its indices.

6. Rows 21, 22, 23, 27, 28 and 29 are formed by the transfer of elements of the primary matrix. Row 26 is a transfer of row 15.

7. The elements of row 24 are those of 17 multiplied by $(-\cos \kappa)$, which is a_{53} ; for row 25 those of 17 are multiplied by $(\sin \kappa)$, which is element a_{13} . Rows 21 through 29 are the partial derivatives of the primary matrix represented by rows 18, 19 and 20.

8. Rows 30 through 33 are the matrix products (equations 7.6 and 7.7) of the vector of row 2 and each of the matrices of rows 18 through 29. It may be evident that row 30 constitutes the "rectified" image co-ordinates for the second photograph (whereas the other terms are auxiliary products needed later on). Again these terms are conveniently formed using a single formula with modified indices.

9. The elements of the U table are formed by means of equations 6.4. (See page 221.)

10. The model co-ordinates of row 34 are formed by means of equations 6.5.

11. Row 35 is the co-ordinate differences between the respective elements of row 34 and row 3: $X - X_0, Y - Y_0, Z - Z_0$;

$$X_{35, j} = X_{34, j} - X_{3, j};$$

which is B of equation 4.3c.

12. The last four rows are the matrix products of rows 18 through 29 and row 35, but in reverse order to that accomplished above in step 8 (equation 4.3c). The term $a_{36,1}$ is an indicator of "scale" inasmuch as it represents an air base length whereas the model base length is assumed to be unity.

13. The preliminary elements of the P table (page 224) are formed by means of equations 5.7, which consist essentially of only two different formulas having different indices and subscripts.

14. The four non-zero elements of the T table are formed using equation 7.10, which again comprises a single formula having different subscripts.

15. The two values of the S table are evaluated by means of equation 7.15, again using a single formula for both values.

16. Finally, the resultant coefficients of the P table are determined as shown by equation 7.17, again using a single equation for all 14 P 's.

9. OTHER PHOTOGRAMMETRIC PROBLEMS

Here an attempt is made to indicate how the relative orientation problem fits into the broader system of photogrammetric mapping. Figure 86 illustrates these ideas. Needless to say, certain elements of the picture may undergo significant if not drastic change in relatively few years in view of some rather important developments now in progress. The numbered elements of the figure are each discussed briefly.

Preliminary operations

1. A relatively few geodetic ground control stations are required in any area being mapped in order to reference the results to an earth datum. It is assumed that the control data consist of three-dimensional rectangular co-ordinates in some appropriate system. The elevations of horizontal stations may not be known; also the positions of vertical stations may not be known. As an example of the frequency of control, there may be one horizontal station per six photographs, and a pair of vertical stations on each fourth photograph, both distributed more or less evenly throughout the photographed area.

The A table

1	x	y	z	Image co-ordinates, first photograph
2	x_2	y_2	z_2	Image co-ordinates, second photograph
3	X_{0-1}	Y_0	Z_0	Co-ordinates of second camera station
4	ω	φ	κ	Sines of camera orientation angles
5	ω'	φ'	κ'	Cosines = $(1 - \sin^2 \theta)^{1/2}$
6	1	0	0	ω -rotation matrix
7	0	ω'	ω	
8	0	$-\omega$	ω'	
9	φ'	0	$-\varphi$	φ -rotation matrix
10	0	1	0	
11	φ	0	φ'	
12	κ'	κ	0	κ -rotation matrix
13	$-\kappa$	κ'	0	
14	0	0	1	
15	φ'	$\omega\varphi$	$-\omega'\varphi$	Intermediate matrix product: $b_{ij} = \varphi_{ik} \omega_{kj}$
16	0	ω'	ω	
17	φ	$-\omega\varphi'$	$\omega'\varphi'$	
18	a_{11}	a_{12}	a_{13}	Resultant matrix product; primary rotation $a_{ij} = \kappa_{ik} b_{kj}$
19	a_{21}	a_{22}	a_{23}	
20	a_{31}	a_{32}	a_{33}	
21	0	$-a_{13}$	a_{12}	
22	0	$-a_{23}$	a_{22}	
23	0	$-a_{33}$	a_{32}	
24	Row 17. ($-\kappa'$)			Partial derivatives of primary matrix relative to φ $\delta a_{ij}/\delta \varphi$
25	Row 17. (κ)			
26	Row 15			
27	a_{21}	a_{22}	a_{23}	Partial derivatives of primary matrix relative to κ $\delta a_{ij}/\delta \kappa$
28	$-a_{11}$	$-a_{12}$	$-a_{13}$	
29	0	0	0	
30	x^*	y^*	z^*	Rectified co-ordinates, second photograph.
31				Auxiliary products row 2 and rows 21 through 29
32	C	$\frac{\delta A}{\delta \omega, \varphi, \kappa}$		
34	X	Y	Z	Model co-ordinates of the object
35	$X - X_0$	$Y - Y_0$	$Z - Z_0$	Co-ordinate differences—second camera station
36	X^*	Y^*	Z^*	"Rectified" model co-ordinates
37				Auxiliary products—rows 18-29 and row 35
38		$\frac{\delta A}{\delta \omega, \varphi, \kappa}$ B		
39				

U_1	U_2	U_3	U_4
-------	-------	-------	-------

$$u_3 = x_1/z_1 \quad u_4 = y_1/z_1$$

$$u_1 = Z_0 x^* - z^* \\ u_2 = x^* - u_3 z^*$$

P_{11}	P_{12}	P_{13}	P_{14}	P_{15}	P_{16}	P_{17}
P_{21}	P_{22}	P_{23}	P_{24}	P_{25}	P_{26}	P_{27}

$$P_{i,j} = \begin{vmatrix} A_{2,i} & A_{2,j} \\ A_{i+36,i} & A_{j+36,j} \end{vmatrix} \quad P_{i,j} = \begin{vmatrix} A_{2,i} & A_{2,j} \\ A_{i,j-21} & A_{j,j-21} \end{vmatrix} \\ i = 1, 2 \quad i = 1, 2 \\ j = 1, 2, 3, 4 \quad j = 5, 6, 7$$

(A is an element of the A table)

$T_1 = 0$	T_2	T_3	T_4	$T_5 = 0$	$T_6 = 0$	T_7
-----------	-------	-------	-------	-----------	-----------	-------

$$T_i = \begin{vmatrix} (A_{31,i} - 1) & A_{32,i} \\ A_{33+i,i} & A_{33+i,i} \end{vmatrix} \quad i = 2, 3, 4 \\ T_1 = T_5 = T_6 = T_7 = 0$$

$$T_7 = A_{30,1} \\ \begin{matrix} S_1 \\ S_2 \end{matrix}$$

$$S_i = (P_{i5} \cdot U_3 + P_{i6} \cdot U_4 + P_{i7}) / U_2 \quad i = 1, 2$$

$$P_{i,i} = P_{i,i} + S_i T_i \quad i = 1, 2 \quad i = 1 \dots 4 \\ P_{i,7} = P_{i,7} - S_i T_7 \quad i = 1, 2$$

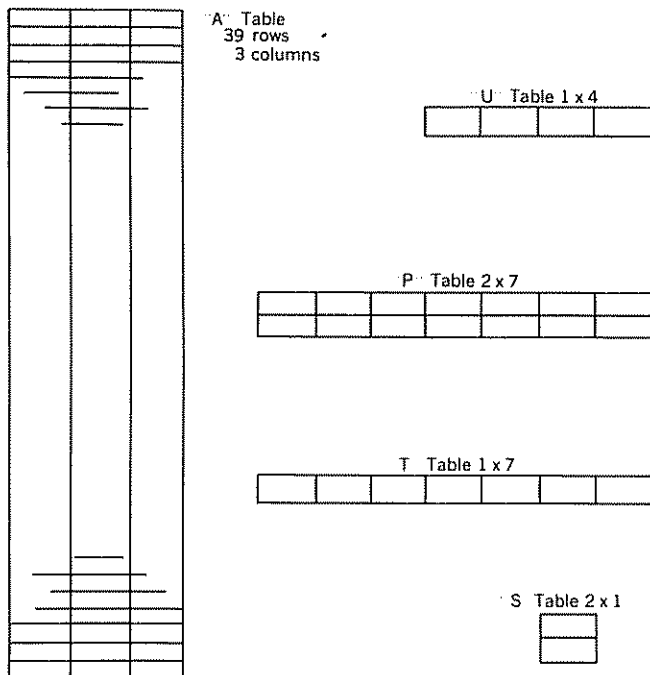

Figure 86. Diagrams of the five tables

2. For purposes of accuracy and the reduction of mistakes in control identification, the control stations should be marked in an appropriate manner prior to aerial photography. Erroneous control identification is probably the largest source of error in the aerotriangulation procedure.

3. Aerial photography is considered to be accomplished with a calibrated camera using film whose dimensional characteristics are satisfactory. The altitude of photography depends on (1) the accuracy required and (2) the eventual use of the photographs. In some instances it may be appropriate to use a high altitude for triangulation and a second photographic coverage of the same area at a lower altitude for purposes of compilation.

4. Carefully controlled dark-room operations are needed, resulting in a lantern slide (diapositive) of each photograph on thick, flat glass plates.

Analytic aerotriangulation

5. Common images need to be marked in the triple overlap areas (where the overlap is 60 per cent) on the diapositives at three uniform locations across the centre of each. Several images (perhaps three) are needed in each location for statistical reasons. The accuracy of marking should be at the limit of image resolution, or with a standard error within about 3 microns. This is done with the Wild PUG-2 point transfer device.

6. The rectangular co-ordinates of each marked image needs to be measured within a standard error of about 2 microns. The reference axes are immaterial. In addition

to images, co-ordinates are also needed of each of the fiducial marks on the diapositive so that the co-ordinates can be referred to the camera axes. The Mann comparator is used for this task. The instrument is digitized to read out the co-ordinates on punch paper tape.

7. The computer operation is composed of several short operations appropriate for an IBM-650.

7.1 Tape-to-card conversion is required of the comparator data. This step will not be necessary if the IBM-1620 is used.

7.2 A "clean-up" programme is needed to (a) average multiple readings, (b) compensate for film distortion, lens distortion and atmospheric refraction. (These systematic errors are allowed to remain in contemporary, classical, conventional and instrumental [analogue] methods.)

7.3 A "housekeeping" or sorting is needed to arrange the data in an appropriate sequence for the computer.

7.4 A series of computer programmes is devised to improve the initial approximations of the six unknown parameters of each photograph preparatory to a photogrammetric adjustment programme.

7.41 The relative orientation of each photo-pair is computed independently from all others, reading out residual discrepancies and model co-ordinates of each image and control point. The residuals become criteria for rejecting or correcting erroneous data and blunders. If data are rejected, the programme is repeated.

7.42 The models are connected in a cantilever fashion, attaching the second to the first, the third to the second, etc., without utilizing geodetic data, using only the linear transformations rotation, dilation and translation.

7.43 The geodetic control needs to be transformed in such a manner as to recognize earth curvature, referring to a geocentric co-ordinate system. The inverse transformation is used later in step 7.6.

7.44 The cantilever can then be adjusted or transformed to fit the control data in a least squares manner, using polynomials of third degree (a) horizontally and (b) vertically. Blunders in control data and control identification can be detected and eliminated. (At this stage, the standard deviation, indicated by the residual fit to the control points, may show that any further adjustments are unnecessary to meet the accuracy requirements of the project, whereupon the computation may terminate with the read-out of the adjusted model co-ordinates. It is expected that the errors at this stage may be significantly smaller than in conventional instrumental methods.)

7.45 "Resection" is the name given to the problem of determining the six parameters of each camera station to fit the adjusted model co-ordinates. One photograph at a time is analysed. The computation is an iterative one using a minimum of three model points. The condition equations are identical to those of relative orientation of step 7.41. Moreover, the coefficients of the observation

equations are the same ones needed in the next operation and deserve storage.

7.5 A grand adjustment of the strip or block of aerial photographs is made by solving all the observation equations simultaneously, together with the control data, for all the unknown parameters (equation 5.1). Due to the close approximations anticipated in step 7.4, it is expected that the grand adjustment will need but a single solution (iteration). The corrections are expected to be small enough for the observation equations to be essentially linear. The output will be adjusted model co-ordinates.

7.6 The model co-ordinates then need to be transformed back into the appropriate geodetic system, which is the inverse transformation of step 7.43. This completes the computation, resulting in a list of co-ordinates of all the model points identified in step 5.

Compilation

8. Topographic mapping (compilation) is then accomplished using stereoscopic instruments such as the Kelsh plotter. The models are formed using the original diapositives and orienting them to fit the marked images to the adjusted model co-ordinates in six locations in each model.

9. Draftsmen are required to put the topographic plots into publishable form.

It is significant that the problem of relative orientation constitutes an important key to the greater problem. It is here that the geometric principles of photogrammetry are utilized, and this is perhaps the only place where any new or obscure mathematical treatment is introduced. Also, the same treatment is utilized again in step 7.45, resection, and in step 7.5, which forms the coefficients of the observation equations for the simultaneous adjustment of a strip or block of photographs.

Moreover, even this problem of relative orientation is not dealt with completely herein. As already mentioned, there are numerous details which also must be considered, such as (1) the formation of the normal equations, (2) the solution of the normal equations, (3) a test for termination of the solution (convergence), (4) modification of parameters, (5) determining the residuals, (6) printing out data needed later, including (a) model co-ordinates, (b) the rotation matrix, (c) the residuals, etc.

The *absolute* orientation of the relatively oriented model is not considered per se in any of these discussions although the problem is solved in the adjustment processes. For a single model it has not been spelled out, although a need may very well exist, particularly in construction and cadastral applications. The problem was recently treated as a special study by the writer in connexion with another programme. The product of such a solution is a list of adjusted geodetic co-ordinates of a large number of objects where the model co-ordinates had been transformed so as to relate properly to those of a few geodetic control points within the model area. This may well be the subject of a subsequent paper.

REPORT ON ANALYTIC AEROTRIANGULATION

Technical paper by Captain L. W. Swanson, United States Coast and Geodetic Survey

It is my pleasure to announce that analytic aerotriangulation is now in productive use in the United States Coast and Geodetic Survey (C & GS), after study and development over a period of four years, and after rigorous testing. Accuracy is very gratifying, as I shall explain presently.

The C & GS method is a variation of the approach developed by Dr. Hellmut H. Schmid¹ of the Ballistic Research Laboratories, Aberdeen Proving Ground, Maryland. The general procedure adapted by C & GS, in which only minor alterations have been made, was described in *Revista Cartográfica* last year². Complete details are in the process of being compiled, but it will be several months before they will be ready for publication.

The C & GS system is perhaps remarkable because of the modest nature of the instruments being used: (1) a stereoscopic image marking device; (2) a monocular comparator, and (3) only a medium-sized electronic computer.

A photogrammetric test area was established in near-by Virginia to aid in the study of the results of analytic and other procedures. The area is 125 kilometres long, essentially in a straight line, and contains many high-order triangulation and elevation points determined recently by the Coast and Geodetic Survey for highway location. The triangulation stations were signalized before the photographs were taken so that errors of control identification would not influence the accuracy of the photogrammetric procedures.

Favourable results are due to several precautions and techniques. The signalization of the horizontal control has already been mentioned. The aerial camera was equipped with an Aviogon lens of 90° angular field. The film was one of the new low-distortion plastic bases. Diapositives were made using an electronic printer on commercial "super-flat" glass. The passpoints and vertical control and test points were identified on a stereoscopic point transfer device and marked by drill holes 65 microns in diameter. (A diameter of 150 microns is being used in practice to facilitate identification later during compilation with a Kelsh plotter.) Four passpoints were used in each of six locations in each model in this test, although only two are being used in practice. Co-ordinate measurement of all the identified control points, passpoints and fiducial marks was accomplished with the monocular comparator having a smallest reading of one micron. The size of the index mark is changed to correspond to the diameter of the drill holes. The data were recorded on punch paper tape as well as by a typewritten record. A tape-to-card converter was used to change the form of the data record so that it would be acceptable to the electronic computer. A card-sorter was used to arrange the cards in proper sequence.

Several different computer programmes were employed for processing the data. (1) The image co-ordinates were transformed so that the origin was at the perspective centre and the co-ordinates were adjusted for film shrink-

age based on the fiducial marks. (2) The image co-ordinates were also corrected for lens distortion and atmospheric refraction. (3) The relative orientation of each model was computed independently, and residual errors and the model co-ordinates for all objects were determined. The residuals were inspected visually and mistaken points were eliminated. (4) The model co-ordinate systems were joined together into a cantilever extension independent of ground control, based only on the initial model. (5) The geodetic control co-ordinates were transformed into a local cartesian co-ordinate system. (6) The cantilever was then adjusted to fit horizontal control and (7) vertical control using separate but related former computer programmes.

Before proceeding any further, I wish to report on the results of the accuracy tests. The root mean square horizontal error was 1:5,400 of the flight altitude and the vertical error was similarly 1:8,000. These test data were obtained from two independent triangulations of sixteen models, each using control and test points as shown in figure 87. A comparative test using a conventional aerotriangulation plotter resulted in errors three times as great.

Specifically, the flight altitude was 6,100 metres; focal length, 153 millimetres; scale, 1:40,000; horizontal *rms* error, ± 1.25 metres; vertical ± 0.75 metre. The horizontal error was based on four control and twelve test points, the vertical on seven control and eleven test points. All the test points were located in those places where the errors were expected to be large, namely, midway between the control points. All the horizontal control and test points were premarked (signalized); the vertical points were not. It should be noted that in each of the two tests the largest span was eight models without horizontal control and five models without vertical control. The adjustment of the aerotriangulation was only the "preliminary" kind which we have been using for several years with instrumental aerotriangulation—the complete "grand" photogrammetric strip and block adjustment was not yet completely programmed. It is expected that this preliminary adjustment may be sufficient for many of our practical applications.

The standard deviation in residual *y*-parallax after relative orientation was less than 5 microns, and subsequent practice has yielded less than 4. It seems that these values are noteworthy inasmuch as they include errors due to image identification and marking, residual film distortion, comparator measurement, etc.

The analytic method already appears to have some distinctive application because of its flexibility. No restriction exists with regard to the focal length or the angular field of the aerial camera, so that essentially any kind of camera may be used. Different lens distortion constants are used with every camera, so that aerotriangulation with the super-wide-angle lenses imposes no variation from the regular procedure.

There is also less restriction with regard to photographic overlap, so that the only difference in 60 per cent, 67 per

¹ H. H. Schmid, "An analytical treatment of the problem of triangulation by stereophotogrammetry", Report No 961, Ballistic Research Laboratories, Aberdeen Proving Ground, Maryland, 1955, and other papers.

² G. C. Tewinkel, "Analytic photogrammetry", *Revista Cartográfica*, v 8, No. 8 (Buenos Aires), page 139.

ANALYTIC AEROTRIANGULATION TEST

Strip width 4.7 miles length 38 miles

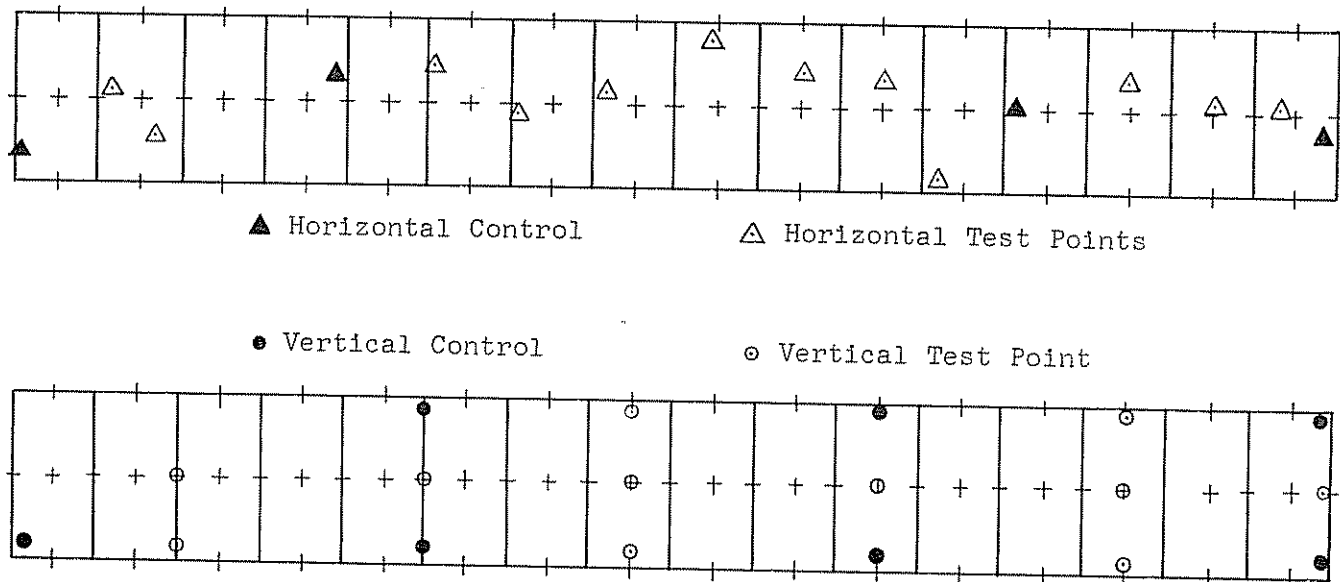

Figure 87. Diagrams of analytic aerotriangulation test for horizontal and vertical control

cent and 80 per cent is the labour involved in the selection of image points. In fact, greater overlap may be utilized to give added geometric rigidity. It is also evident that one can fly the photographs on arcs as well as straight lines, which we are now doing for a special application. A side lap of 60 per cent is both feasible and preferable for more than one strip.

Block adjustment presents no particular problems. The observation equations used in relative orientation also apply unchanged to the problems of resection; strip adjustment and block adjustment and large systems of equations are solved routinely by the computer. Common passpoints are identified on adjoining strips with the point transfer device without difficulty.

Occasionally, because of our work near the ocean, a significant portion of a model is covered by water, imposing an insurmountable problem in instrumental aerotriangulation. Although such occasions always decrease accuracy, relative orientation is nevertheless solvable by the analytic method. The difference of source lies in the fact that, instrumentally, parallax should be removed at points along axes of rotation where some adjustments have a null effect; whereas, analytically, the relative values of the various adjustments are recognized through the coefficients in the observation equations.

The test accuracies indicate that aerotriangulation can now be accomplished using a great flight altitude for the purpose of establishing photogrammetric control to be used in map compilation from photographs taken at a lower altitude. This is particularly applicable if the control is signalized.

The analytic procedure has now been placed in operation alongside of conventional instrumental methods. Through its actual application, we hope to learn more of its possibilities as well as its limitations. Already, improvements in techniques and operations are noted due to our brief experience.

* * *

The first application of analytic aerotriangulation to a mapping project has just been completed. The following summary of results will be of interest.

The analytic aerotriangulation included six parallel strips of photographs taken with a six-inch super Aviogon lens at an altitude of 15,000 feet (scale, 1:30,000). There were an average of nine models per strip and a total of twelve horizontal control stations for the six strips.

The ground control was not premarked but was identified by ground survey after completion of the photography.

Each strip was triangulated separately and the strips joined by holding control and tie points and averaging the differences in position of tie points common to two adjoining strips.

In the adjustment of individual strips to ground control the average residual error at ground control stations for the six strips was 2.0 feet and the maximum error at any ground control station was 8.4 feet.

The average of the differences in positions of tie points between adjoining strips was 4.2 feet and the maximum differences was 7.9 feet.

VERTICAL AERIAL TRIANGULATION BLOCK ADJUSTMENTS

Technical paper¹ by Frank W. Masek, United States Army Map Service

ABSTRACT

An effective method of block adjusting vertical aerial triangulation data mathematically, using high-speed electronic computers, is a desirable but as yet unachieved goal. The author reviews present Army Map Service techniques of vertical block adjustment, analyses the shortcomings of such techniques, and advances a method of adjustment designed to increase the accuracy of the adjusted data. The method involves the establishment of a unified instrument co-ordinate system for a block of strips and the fitting of this co-ordinate block data to the earth's surface. Comprehensive testing of the method will ultimately determine the mathematical finesse required to achieve the desired results.

The United States Army Map Service recently developed a method of block adjusting horizontal aerial triangulation data mathematically, using a high-speed electronic computer (UNIVAC), and has used this method successfully on several map production projects. The block adjustment of vertical aerial triangulation data, using similar techniques, remains an unachieved, although very desirable, goal.

The block adjustment technique, as a tool of the photogrammetrist, is relatively new, and photogrammetric literature generally has little information concerning this important subject.

The method of vertical block adjustment now used at the Army Map Service was first used by the late Charles W. Price and is essentially a modification of a method outlined in a 1956 report by the Mapping and Charting Research Laboratory of the Ohio State University Research Foundation.² Prior to this, a method involving iso-error contours was used. In either case, the adjuster is allowed no margin for error since both methods require a fundamental assumption that all control used in the solution is reliable in all respects.

At the present time, vertical block adjustments are infrequently used at Army Map Service and are totally graphical in nature. Generally, such methods are used in production only in localized areas where adequate vertical ground control is lacking, where logical stream or terrain gradients are indeterminable, and where nothing else seems to work. Categorically, vertical block adjustments have been used, not as basic, but as supplementary, adjustment techniques. To borrow a colloquialism, they have been little more than "gimmicks" which redistribute rather than remove errors which already exist in the original strip solutions.

One of the requirements of such graphical block adjustments is that all strips within the block must first be independently adjusted to the existing vertical control by accepted photogrammetric methods. If the elevation differences of passpoints common to adjoining strips are

within the tolerances for the project, these differences are meaned and no further adjustment beyond meaning is performed. If, however, those elevation differences generally exceed the tolerance, they may be reduced by resorting to a vertical block adjustment.

Characteristically, the passpoint differences are greater in magnitude between the control bands. A thorough analysis is made to remove differences caused by bad control or operator errors, but the remaining differences are more difficult to analyse. More specifically, are these differences caused by datum errors or by lateral tilt errors in the photogrammetric bridge, or by a combination of the two? How do the various types of errors in adjoining strips contribute to the total differences? If it were possible to analyse the passpoint differences and determine the error components for each strip, the problem of removing the differences could easily be solved.

Figure 88 shows a lateral cross-section of a hypothetical area covered by seven strips, all of which were previously adjusted to the available vertical control. Only strips 1 and 7 are considered satisfactorily adjusted to the

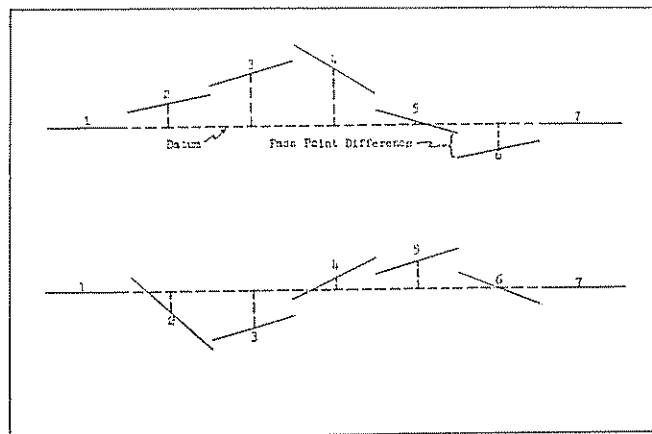

Figure 88. Datum and tilt error possibilities in a typical block of strips

proper datum and free of tilt within the tolerances for the project. Strips 2 to 6, inclusive, require further adjustment. The upper and lower portions of figure 88 indicate only two of an infinite number of possible combinations of datum and lateral tilt errors which could account for the differences shown between strips. Obviously, any method of readjustment which is based on the differences between strips and which assumes the causative factors, will have difficulty removing all the differences.

Reasonable success, however, has been achieved with the present Army Map Service method of vertical block adjustment. In this method, vertical control is required only along the perimeter of the block. The interior strips are, therefore, uncontrolled except at the ends.

The vertical datum of each strip in the block is readjusted in the direction of the mean vertical datum of the block at preselected abscissae along the flight line of each strip by pro-rating the strip and block datum differences as a function of the distance of each strip from the middle strip of the block. Consequently, the percentage change

¹ The information contained herein does not necessarily represent the official views of the Corps of Engineers or the Department of the Army.

² Mapping and Charting Research Laboratory, Ohio State University, "Aerial triangulation by least squares", Third Interim Technical Report, January-March 1956, pages 117 to 145.

will be greatest at the middle of the block. One-half of the adjusted passpoint differences are then used in an auxiliary graphical readjustment of the passpoints along the edges of each strip according to the best mean fit of a flexible spline to the plotted values. Any remaining differences are then meaned.

This method was used on a 13,000-square mile area of a production project, which was completely devoid of vertical control except along the perimeter, as shown in

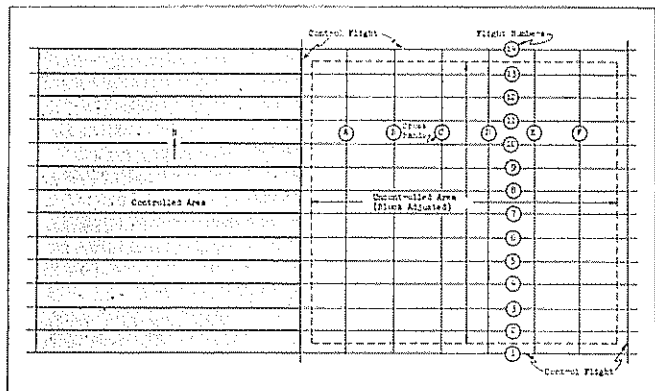

Figure 89. Diagram of production project showing block adjusted area

figure 89. Fourteen east-west flights, flown at 30,000 feet above sea level, and averaging forty-three models each, or a total of 602 models, were involved in the block adjustment. For this project a fifty-metre contour interval with a vertical error tolerance in aerial triangulation of ten metres on control and a difference tolerance of

twenty metres on common passpoints had been established. Six north-south cross bands, each two models wide, the centres of which were approximately six models apart, were used to obtain the data for the vertical block adjustment. These cross bands, A through F, are not aerial photographic missions but narrow bands of terrain along which the elevation differences between adjoining flights were computed.

The entire project was first adjusted to the available geodetic control. The shaded area in figure 89 was not block adjusted because the photo ties between strips were within tolerance after the initial strip adjustment. The area bounded by the dashed line in the figure was block adjusted.

After the normal strip adjustment, the passpoint differences were readjusted mathematically along the cross bands to obtain the plots for the graphical correction curves along the flight line. The best mean fit of a flexible spline to these plotted values determined the corrections to be made to the passpoint elevations.

Figure 90 shows the results of the block adjustment of this area. For example, in the first column when strip 2 was compared with strip 1, after the usual strip adjustment, strip 2 was 30.0 metres higher than strip 1, as indicated by the Δ_z difference shown in cross band A. Correspondingly, after the block adjustment, strip 2 was 24.6 metres higher than strip 1, as shown by the Δ_z' value in cross band A. The maximum difference of 73.9 metres (cross band C) was reduced to 44.1 metres. The standard error of the passpoint differences prior to the block adjustment was 19.3 metres. This was reduced by the block adjustment to 14.1 metres, a reduction of 27.3 per cent in the over-all passpoint differences for the area. Prior to the block adjustment, 16.7 per cent of the passpoint

Strip Nos.	Cross Band Designations											
	A		B		C		D		E		F	
	Δ_z	Δ_z'	Δ_z	Δ_z'	Δ_z	Δ_z'	Δ_z	Δ_z'	Δ_z	Δ_z'	Δ_z	Δ_z'
2-1	+ 30.0	+ 24.6	- 7.3	- 18.9	+ 15.2	+ 0.6	+ 25.7	+ 23.0	- 51.0	- 28.5	- 11.9	- 4.9
3-2	- 3.5	+ 10.9	- 10.5	+ 3.8	- 19.3	- 13.0	- 14.0	- 11.6	+ 20.0	+ 33.5	- 11.9	- 25.0
4-3	- 3.5	+ 5.9	- 1.0	+ 11.9	+ 27.2	- 4.4	- 21.2	- 32.5	+ 72.0	+ 41.7	- 11.9	- 32.1
5-4	+ 11.0	+ 19.7	+ 4.0	+ 14.5	- 73.9	- 44.1	+ 0.8	+ 19.2	- 4.4	- 3.3	- 11.9	- 5.3
6-5	+ 29.0	+ 14.4	- 19.0	- 9.0	+ 22.0	+ 6.9	+ 22.0	- 6.9	- 6.7	- 18.2	- 11.9	- 0.4
7-6	+ 12.0	- 9.5	+ 55.0	+ 16.8	+ 16.2	+ 2.8	+ 6.4	- 14.5	- 0.9	- 7.1	+ 6.4	+ 13.4
8-7	- 10.7	- 4.5	+ 7.0	- 1.2	+ 14.6	+ 9.6	- 3.6	- 11.9	+ 1.7	- 2.2	- 2.0	+ 9.0
9-8	+ 19.0	+ 8.5	- 6.0	- 4.7	- 26.6	- 2.1	+ 4.2	+ 1.4	+ 0.4	- 0.8	+ 7.0	+ 9.0
10-9	- 2.9	- 8.2	+ 5.5	+ 0.7	- 2.9	+ 13.4	- 37.9	- 18.7	+ 3.5	+ 1.6	- 19.5	- 3.5
11-10	+ 19.3	+ 4.2	- 8.5	- 11.6	+ 0.8	+ 7.1	- 9.5	+ 3.0	+ 0.3	- 8.8	- 1.5	+ 7.0
12-11	- 5.6	- 11.8	+ 2.0	- 2.7	- 8.6	- 2.8	+ 10.0	+ 11.0	- 2.3	- 10.9	+ 1.0	+ 4.7
13-12	+ 5.6	+ 0.6	+ 3.7	+ 1.7	- 8.6	- 4.3	- 3.7	+ 0.4	- 11.9	- 10.2	+ 2.0	+ 7.0
14-13	+ 16.6	+ 9.6	+ 0.8	- 8.2	+ 5.2	+ 3.0	- 15.8	- 11.8	+ 1.3	+ 4.0	- 1.5	+ 1.5
RMSE	15.8	11.9	17.0	10.1	25.8	14.0	16.9	15.5	25.4	18.4	9.6	13.0

Note: Δ_z = Pass Point Differences Before Block Adjustment - - Δ_z' = Block Adjusted Pass Point Differences.

Figure 90. Vertical block adjustment passpoint differences (in metres) before and after block adjustment

differences exceeded the prescribed tolerance of 20 metres. After the block adjustment, only 11.5 per cent of the differences were larger than the tolerance. In areas where large differences remained, the error tolerance during the compilation phase of the mapping was necessarily reduced from the norm.

A test of the ITC-Jerie method of vertical block adjustment was recently carried out in Austria with RC-5 photography taken at an altitude of 3,430 metres.³ An area of eight strips averaging twenty models per strip was block adjusted, using control spaced at five, seven and ten-model intervals. Using the ITC-Jerie analogue computer in conjunction with the IBM-650, the Austrians achieved absolute vertical accuracies of 1/4,000th of the flight altitude. This is certainly a commendable achievement.

A somewhat different method of vertical block adjustment is one requiring the use of 60-65 per cent side lap, precision aerial photography. The method, which at present remains untested, involves, in addition, the establishment of a unified instrument co-ordinate system for a block of strips and the fitting of this co-ordinate block data to the earth's surface.

A preliminary horizontal and vertical strip-to-strip transformation adjustment would be made to a single strip selected as the base. Because of the increased side lap, the relative differences of *x*-tilt, *y*-tilt and scale between the several strips could be minimized. This would overcome the difficulties experienced with the previously described Army Map Service method. The result would be a common block of instrument co-ordinates which could then be adjusted to the available ground control.

Figure 91 shows the relationship between the instrument co-ordinate surface of a block of strips and the earth's surface. A sample row of passpoints is shown along both the longitudinal and the transverse axes of the block. The vertical dashed lines from these points to the earth's surface indicate the errors between the instrument co-ordinate system and the geoid. The available control in the area need not be dense but should be well distributed. A minimum of five good vertical control points, one in each of the corners plus one in the centre of the block, would probably suffice for such a rectangular area.

It is difficult to visualize graphical adjustment by this method. Adjustment by high-speed electronic computers would require first of all the establishment of the correct geometrical relationship between the photogrammetric co-ordinates and the geoid. The error surface generated would approach the equation for a surface of revolution, the general nature of which can best be determined by a series of tests.

³ P. Waldhausal, *Photogrammetria*, v. XVI, No. 1, 1959-1960, pages 29 to 37.

One of the disadvantages of such a method would be the increased effort required on the part of the triangulation personnel. The increased number of strips triangulated, however, would be more than offset by the resulting increase in accuracy. Another possible disadvantage is that the compilation phase of a project would be delayed until sizable portions of the project were triangulated and

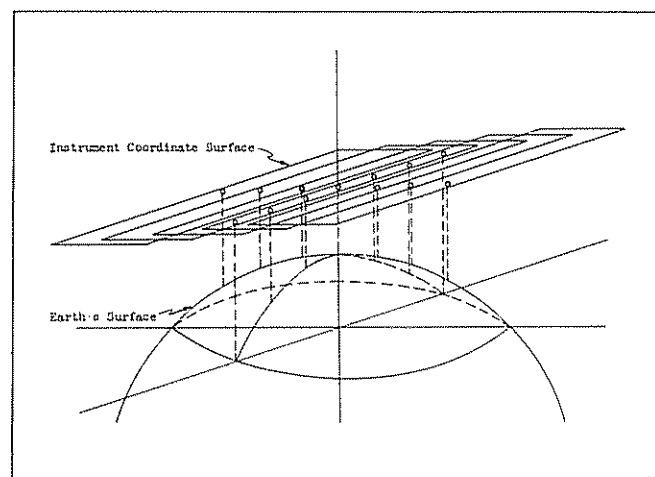

Figure 91. Relationship between the earth's surface and the instrument co-ordinate surface of a block of strips

adjusted. In the preparation of maps by mass production techniques patience sometimes wears thin, but here again increased accuracy should be the paramount consideration.

Another consideration, appropriate at this point, would be the size of the block that could be effectively handled. The numerical and storage capacities of electronic computers vary considerably. The size of the block, therefore, would depend on the type of computer available and the accuracy desired.

The primary advantage of this method is that less ground control than is at present required would be needed to control a given area. The elimination of erroneous control points would be easier and the analysis of photogrammetric errors would be facilitated. Increased accuracy should result, since in most cases a triple check of the passpoint determinations would be made. A programme of comprehensive testing will likewise indicate the mathematical finesse required to achieve the desired results.

The over-all improvement of vertical block adjustment techniques, over those of the strip, should be significant. The specific benefits of this proposed method, however, can only be determined from the results of a series of comprehensive tests.

(b) International standardization of map scales, format, accuracy classification and map symbols

COMPARISON OF STANDARD CARTOGRAPHIC PRACTICES FOR LAND MAPS (SCP)
AND THE SPECIFICATIONS FOR JAPANESE TOPOGRAPHIC MAPS¹

At the Second United Nations Regional Cartographic Conference for Asia and the Far East held in Tokyo in 1958, it was recommended that the Standard Cartographic Practices for Land Maps (SCP),² submitted to the Conference by France, be adopted for new mapping work.

Comparison of the specifications for Japanese topographic maps with SCP prompts the following remarks.

¹ The original text of this paper, submitted by Japan, appeared as document E/CONF.36/L.73.

² See United Nations, *World Cartography*, vol. VI (Sales No.: 60.I.10), pages 19 to 46.

(1) The specifications for Japanese topographic maps correspond to most of the SCP items, as can be seen from the attached table of comparison.

(2) On Japanese topographic maps, place names are inserted only for domestic use.

(3) The standard system of evaluating land maps in SCP is adequate for domestic use.

(4) SCP does not refer to sheetline and sheet numbering systems; a cartographic system should be adopted having as its base the IMW reference system.

Table of comparison between the standard cartographic practices for land maps (SCP) and the specifications for Japanese topographic maps

Item ^a	SCP	Japanese topographic maps
I. Geodetic data	It is desirable that the International spheroid be adopted in the future. If that should be impossible, one of the following spheroids should be used: Clarke 1866; Clarke 1880; Everest; Bessel; International; Krassowsky	Bessel spheroid; IMW series based on International spheroid
Projections	UTM	UTM for new topographic maps (1960). Conformal conic for IMW new edition
Grids	UTM grid system	No grid is printed on the ordinary edition
II. Units of vertical measure	Metric system	Same as SCP
III. Map scales	Standard scales: 1:25,000; 1:50,000; 1:100,000; 1:200,000; 1:250,000; 1:500,000; 1:1,000,000	The scales are as follows: maps of partial areas, 1:25,000; maps covering the whole country, 1:50,000; 1:200,000; 1:500,000; 1:800,000; 1:1,000,000
IV. Edition designation	In the right half of the upper margin of the sheet, for example: Edition I In addition, the month and year may be added, for example: <i>Edition 3—May 1954</i> The coded initials of the mapping agency responsible for that edition may also be added if desired: <i>Edition 7—IGNF—1957</i>	The edition designation is not printed
V. Specifications for vertical aerial cartographic photography	[Specifications not reproduced in the present paper; see <i>World Cartography</i> , vol. VI]	It is possible to adopt these specifications
VI. Evaluation of land maps	In order to make the best use of topographic land maps it is necessary to establish the criteria for planimetric accuracy, for relief accuracy, for completeness and state of revision, etc.	There is no fixed system for the evaluation of maps. It is possible to adopt this system as a standard for evaluation of sources and judgement of revision

Table of comparison between the standard cartographic practices
for land maps (SCP) and the specifications for Japanese topographic maps (continued)

Item ^a	SCP	Japanese topographic maps
VII. Marginal information on topographic land maps	<p>Essential items:</p> <p>(a) Sheet name or title</p> <p>(b) Sheet number and identification</p> <p>(c) Edition designation</p> <p>(d) Series title</p> <p>(e) Numerical scale</p> <p>(f) Graphic scales</p> <p>(g) Index to adjoining sheets</p> <p>(h) Conventional signs legend</p> <p>(i) Contour interval</p> <p>(j) A brief history of sheet</p> <p>(k) Meridian convergence and declination diagram or note</p> <p>(l) Ellipsoid of reference, geodetic datum, projection used and levelling datum</p> <p>(m) Geographic co-ordinates of sheet corners</p> <p>(n) Copyright restrictions</p> <p>It is considered desirable that the following marginal data should be shown when appropriate and if space permits:</p> <p>(a) Compilation diagram</p> <p>(b) Aerial photographic coverage diagram</p> <p>(c) Abbreviations and glossary</p> <p>(d) Administrative boundaries diagram</p> <p>(e) Conversion diagram, feet/metres</p> <p>Marginal information in the space adjacent to neat line:</p> <p>(a) The destination of roads or railways</p> <p>(b) That portion of a name which overlaps into the next sheet</p> <p>(c) Sheet corner co-ordinates</p> <p>(d) The values of the graticule lines</p> <p>(e) Grid figures, if a rectangular grid is printed on the map</p>	<p>Most items coincide with SCP. The following items are not shown:</p> <p>(a) Edition designation</p> <p>(b) Meridian convergence</p> <p>(c) Ellipsoid of reference</p> <p>(d) Abbreviations and glossary</p> <p>(e) Conversion diagram, feet/metres</p> <p>(f) Sheet corner co-ordinates</p> <p>(g) The values of the graticule lines</p>
VIII. Conventional signs	<p>This item is for guidance only. It is desirable to unify the shapes of symbols</p>	
Road classification	<p>(1) All weather hard surface</p> <p>(2) All weather light or loose surface road</p> <p>(3) Fair weather road</p> <p>(4) Roads for one way traffic</p> <p>(5) Roads for two way traffic or more</p>	<p>Road classification for the 1:50,000 and 1:25,000 series</p> <p>(1) Paved road</p> <p>(2) Road having broken parts</p> <p>(3) Dry weather road</p> <p>(4) Other road</p> <p>(5) Roads for three way traffic or more</p> <p>(6) Road for one-two way traffic</p> <p>(7) Roads for light cars</p> <p>(8) Cart track</p> <p>(9) Footpath</p>
Coastal hydrography	<p>The indications are as follows:</p> <p>(1) Foreshore features</p> <p>(2) Bathymetric contours (depth curves)</p>	<p>The indication of bathymetric contours is given only on the 1:200,000 maps</p>

Table of comparison between the standard cartographic practices for land maps (SCP) and the specifications for Japanese topographic maps (continued)

Item ^a	SCP	Japanese topographic maps
<i>Part I. Conventional signs to be used on maps on scales of 1:25,000 and 1:50,000</i>		
Railroads	Broad gauge railroads; normal gauge railroads; narrow gauge railroads; tracks not in operation (under construction, abandoned, etc.); other lines, e.g., aerial cableway, funicular, etc. (These symbols coincide with ICAO WAC)	(1) Railroads with normal or broad gauge are classified as: national railroads; private railroads. They are symbolized by interrupted lines with both side-lines (2) The classification of other lines is like that of SCP, but the symbols are different
Roads	All weather, hard surface roads—overprint in solid red; all weather, loose or light surface, roads—interrupted overprint in red; fair or dry weather, loose surface, roads—no colour filling. The width of roads to be distinguished by the gauge of the symbol	Classified as follows: paved roads—overprint in brown dotting; broken part of roads—oblique brown cross; dry weather roads—couple of one-side interrupted lines; other roads—no colour filling. The width of roads to be distinguished by the gauge and the line weight of the symbol
Waterways	Canals which, as a minimum, are fifteen metres wide and approximately two and one-half metres in depth, should be marked "NAVIGABLE" in addition to the conventional sign	The course of regular ship service is indicated, but no other "navigable" sign is used
Built-up areas	Outline—black; inside area—solid half-tone red	Inside area—sloped parallel lines Classified as follows: permanent building; greenhouse; livestock-house
<i>Part II. Conventional signs to be used on maps on scale of 1:100,000</i>		
[Specifications not reproduced in the present paper; see World Cartography, vol. VI]		
<i>Part III. Conventional signs to be used on maps on scales of 1:200,000 and 1:250,000</i>		
Matching of colours	Black—culture, annotations, sheet lines, latitude and longitude lines; blue—hydrography; brown—terrain, distorted surface area; red—road classification, international boundary (half-tone belt); green—forest	Black—same as SCP and forest on flat land, and falls; blue hydrography, rice fields; brown—distorted surface area, roads, rural settlements; red—urban areas; green—contours, shading, farms
Other	As for part I above	
<i>Part IV. Conventional signs to be used on maps on scale of 1:500,000</i>		
Roads	(a) Dual highway (b) Main road (c) Secondary road (d) Other road (e) Track and path (f) Road under construction	Roads classified as follows: (a) First class national road (b) Second-class national road (c) Main provincial road (d) Other road (e) Track and path

Table of comparison between the standard cartographic practices for land maps (SCP) and the specifications for Japanese topographic maps (continued)

Item ^a	SCP	Japanese topographic maps
Other	As for part III above	<p>Matching of colour</p> <p>Black—culture (except roads), annotations, sheet lines, latitude and longitude lines; blue—hydrography; brown—roads; red—urban areas, symbols for aerodromes, lighthouses and volcanoes; green—contours, hachures. Others are approximately the same as 1:200,000 series</p>
<p>Part V. Conventional signs to be used on maps on scale of 1:1,000,000</p>	As for IMW	Same as SCP
<p>IX. Spelling of geographical names</p>	<p>The Roman alphabet should be used on all maps and charts produced for international use. In non-Roman alphabet areas the transliteration should accord with the systems agreed jointly by the United States Board on Geographical Names (BGN) and the British Permanent Committee on Geographical Names (PCGN). In cases of varying romanized form and spelling, the form and spelling used in the principal romanized maps should be adopted. Romanized names obtained by transliteration may appear in brackets in such cases. Other conventional names should appear in brackets after the official Roman or transliterated form of the name</p>	<p>There is no international edition except IMW. The governmental system of romanization is adopted for IMW</p>
<p>X. Trig lists (lists of geodetic data)</p>	<p>In the normal way, the area covered by a trig list should correspond to one or more sheets in the main maps series for the area. Detailed information should be given in a separate pamphlet. [Other specifications not included in the present paper]</p>	<p>Trig lists prepared for each map of the 1:50,000 series. The items of the list are like those in the SCP</p>
<p>XI. Indexes of names on land maps (map gazetteers)</p>	<p>All names and terms which identify features or places on the map should be indexed. The following data should be given in successive columns:</p> <p>(a) The name as it appears on the map;</p> <p>(b) Abbreviated designation of the object to which the name refers, using a group of four letters or less;</p> <p>(c) The reference to the name in grid co-ordinates, if a grid is used;</p>	<p>All names on the basic maps are indexed and correspond to the 1:50,000 series (or the 1:25,000 series in some areas). The location of each name is indicated by the cardinal number in each map. The pronunciation of the name is explained by "Kana" letters and not by romanization or other transliterations</p>

Table of comparison between the standard cartographic practices for land maps (SCP) and the specifications for Japanese topographic maps (continued)

Item ^a	SCP	Japanese topographic maps
	<p>(d) Sheet numbers (when the name appears in more than one sheet or in sheets of more than one series, sheet numbers of each should be shown, if possible);</p> <p>(e) Latitude;</p> <p>(f) Longitude</p> <p>It is desirable that the names on maps should be listed in the indexes of names on land maps (map gazetteers) in alphabetical order</p>	

^a The numbers and categories listed in this column correspond to those in "Standard cartographic practices for land maps", *World Cartography*, vol. VI.

(c) Co-operation in mapping of frontier areas

PROPOSAL SUBMITTED BY THAILAND¹

Since the use of aerial photography has proved to be the most rapid and most economical way of mapping, many countries in Asia and the Far East have undertaken projects for the aerial photography of their areas. In Thailand, such a project began seven years ago. During the course of implementation, many problems were encountered in dealing with border areas adjoining neighbouring countries. The main problems were related to:

(a) The provision of data on the adjoining areas in neighbouring countries appearing on the sheets;

(b) Overflights of the border areas by photographing planes;

(c) The execution of ground controls and classification surveys in border areas.

As a rule, in the making of maps covering the border areas of one country, it is impossible to avoid any overlap with the adjoining areas of other countries. To ascertain accurate cartographic details for these areas requires the co-operation of the neighbouring country concerned.

Several cases may be considered.

(1) *The neighbouring country has in its possession data useful for compiling the maps over that area.*

(a) It would be desirable to provide the mapping country with maps as up to date as possible and on a scale as close as possible to that of the projected maps, together with the geographical names appearing on maps. In case the vernacular language is used, the romanized equivalent should also be given.

(b) The neighbouring country has not available up-to-date maps covering the area. In such a case, vertical (or near vertical) aerial photographs suitable for map making constitute a good substitute. It is also desirable to include the following data:

- (i) Photo control points needed for stereotriangulation;
- (ii) Passpoints for control between models in cases where stereotriangulation has been carried out.

All these data should be compiled clearly in the form of a list of geographical co-ordinates or rectangular co-ordinates specifying the horizontal and vertical data and the spheroid employed.

(2) *The country does not have the data referred to in (1) above. It would be necessary to make arrangements to permit the mapping country to overfly the border areas in order to take the required photographs.*

In the case of field work over the border area by the mapping country, such as ground control or classification survey operations, local conditions may necessitate occasional border crossing by surveying teams. It is highly desirable that general arrangements for simple formalities be agreed in advance in order to cope with the urgent situation.

To speed up the solution of the various problems mentioned above, it is suggested that a committee be set up, composed of interested countries, to draft:

- (a) An agreement on overflights of border areas—
 - (i) Aerial photographs taken by the personnel of the mapping country;
 - (ii) Aerial photographs taken by contracting enterprises or by a third country;
- (b) An agreement on the border crossing of surveying teams—
 - (i) Survey operations performed by the mapping country;
 - (ii) Survey operations performed by a contracting enterprise;
- (c) An agreement on the exchange of data for map making of border areas.

¹ The original text of this paper appeared as document E/CONF. 36/L.10.

(d) Organization and operation of a national map information office

THE FUNCTION OF A NATIONAL MAP INFORMATION OFFICE¹

Background paper by J. O. Kilmartin, United States Geological Survey

In the United States there are several agencies engaged in programmes of basic surveys and maps, and they produce many different kinds of maps and charts, geodetic control and aerial photography. For these reasons there was formed, more than forty years ago, a national office located within the Geological Survey for disseminating surveying and mapping information to other agencies at all levels of government throughout the entire country, and to the general public as well. It should be emphasized that the primary purpose of the Map Information Office is not actually to sell or distribute maps, aerial photography or geodetic control lists, but only to disseminate information on what is available, where it can be located and how to order it.

The Map Information Office of the US Geological Survey began in 1919 as a one-man organization. It now includes about thirty people, who annually process more than 100,000 requests for information about surveys or maps. Most of the requests are made by mail, but many important and urgent requests are made by telegraph or telephone. Much of the work of the Map Information Office is carried on by three groups of specialists. One group specializes in information regarding topographic maps, another deals with aerial photographs and the third handles information regarding geodetic control surveys.

The specialists for topographic maps keep continuously informed regarding all topographic surveys and maps of any part of the United States, produced by any government agency. The results are then shown on the widely distributed 1:5,000,000-scale index map entitled *Status of Topographic Mapping in the United States*, which is annually revised and republished. This status map shows by colours and patterns the areas covered by existing topographic maps produced by agencies of the Federal Government, and the scales of the maps. Also, for each map scale the status map indicates in which of four grades of quality each map is classified, beginning with the highest grade, the newer, up-to-date maps produced from standard-accuracy surveys, and ending with the lowest grade of old, obsolete, reconnaissance-type maps. In addition, the status map shows where new topographic surveys are in progress, as well as those areas where no topographic quadrangle maps of the national series are yet available.

The specialists for topographic maps also maintain historical files of all topographic maps produced by any of the government agencies. The magnitude of this task can be better appreciated when it is realized that the Geological Survey last year (1960) published nearly 1,400 new topographic quadrangle maps, as compared to about 140 in 1940, and that the total number of topographic maps now published and available to the public is more than 20,000 and in another ten years it may be nearly 40,000.

As a special service to map users, the Map Information Office arranges to furnish, for a small charge, copies of new topographic maps prior to publication. These are one-colour photographic copies of the photogrammetrically compiled map sheets, either before or after field survey inspection, which are available as much as two years prior to publication of the final multicolour map. Such advance copies are much in demand by geologists, engineers and other professional people.

The specialists in aerial photography continuously assemble information on all new photography of any part of the United States, whether obtained by agencies of the Federal Government or the states, or by commercial organizations. Their records, the most complete and authoritative in existence, show the name of the agency or organization holding the negative film, date of photography, flight altitude, approximate scale of the photographs, focal length of the camera lens and the type of camera used. The immensity of this task of record keeping and dissemination of information becomes clear when it is realized that recently in one year aerial photography was procured for a number of areas totalling about one million square miles, and that the cumulative records of this group account for more than eleven million square miles of photography, enough photographic coverage to cover all parts of the United States more than three times.

The photography that is available is made known to the public by means of a published index map, at a scale of 1:5 million, entitled *Status of Aerial Photography in the United States*, which is revised about every two years. This status index shows by colour and patterns the photography available for each area and the address where copies of the photographs may be obtained.

The specialists on information regarding geodetic control data continuously maintain complete records of all control survey results, both horizontal and vertical, of the Coast and Geodetic Survey, the Geological Survey, and certain other agencies of the Federal Government, as well as a few agencies of state governments. These records now contain the descriptions with positions and (or) elevations of about six million points, ranging from monumented first-order stations or bench-marks to the fourth-order picture points which are used for control of topographic maps prepared by photogrammetric procedures. Complete information for all control points within each fifteen-minute quadrangle area, revised as frequently as may be warranted by new work, is published and distributed as one list. The lists are available to the public for a small charge.

Published multicoloured diagrams showing the location of all geodetic control resulting from the work of the Coast and Geodetic Survey and the Geological Survey are being prepared and issued as rapidly as possible. The base sheets for the diagrams are the sectional maps of the 1:250,000-scale series. Each sheet covers 1° of latitude by 2° of longitude, and a total of 468 sheets will

¹ The original text of this paper, submitted by the United States of America, appeared as document E/CONF.35/L.51.

be required to cover the entire area of the United States. Although this type of location diagram, or map index, for control surveys was started only a year ago, the first edition of the entire set of sheets should be available by about 1963. Revised editions will then be published when needed to show the locations of new control surveys.

It is hoped that this brief résumé concerning the purpose and activities of the Map Information Office in the United States may be helpful to those who might wish to consider establishing information centres in other countries. Additional information will be supplied to anyone who is interested in exploring the subject.



AGENDA ITEM 14

Photo-interpretation

(a) Review of new techniques and developments

LAND USE AND FOREST RESOURCE SURVEY IN TAIWAN¹

GENERAL DESCRIPTION

Over 1,969,500 hectares of land area in Taiwan are forested, of which about 80 per cent, or 1,409,900 hectares, are government land. For management purposes, the government forests are divided into forty-one working circles. Of the non-forest areas of Taiwan, over 600,000 hectares are undergoing severe to extremely severe soil erosion. Rapid land use changes were found to be taking place during the post-war years from brush, grassland and hardwood forest to upland dry farming; from tidal flats or sand beaches to fish ponds or crop fields, and from cultivated field to urban or industrial uses. As part of the continuing efforts on the part of Government and the farmers to produce more food and develop resources, emphasis is laid on the regulation and inventory of natural resources in the four-year economic development plans. Some forest, land use and natural resources reconnaissance projects are carried out using aerial survey methods.

In order to meet the needs of economic reconstruction, the Government of the Republic of China in Taiwan has completed aerial photography covering the whole island on a scale of 1:40,000 for land use, forest and agricultural rehabilitation projects. In some critical areas air photos were taken on large scales for construction of the maps on scales of 1:10,000 and 1:5,000 required for economic development planning.

The following aerial surveys for resource development have been or are being done in Taiwan.

LAND USE AND FOREST RESOURCES SURVEY OF TAIWAN

The objectives of the survey of forest resources are (1) to yield reliable data on forested land area and timber volume, including current growth and mortality, and other data needed to formulate a forest policy which would ensure proper management of the forest resources of Taiwan with a view to a sustained yield, and (2) to furnish information and suggestions on forestry establishment to various forest agencies.

In the survey, the aerial photogrammetric technique was applied. Twenty-four strips were flown in an east-west direction at right angles to the general topography to take aerial photos. These photographs were taken with lens of twenty-four-inch focal length, minus blue filter and infra-red film on scales of 1:10,000 to 1:8,000.

A double stratified sampling method was applied to this survey. Photo sample plots, totalling 37,495, were selected at random on the sample strips. They were first classified as forested and non-forested land and stratified by volume class and conservation problem area class for these two major land use types. A total of 545 ground plots were chosen at random from the photo plots in each stratum. The photo plot was the basic sample for obtaining forested and non-forested areas and timber volume, and ground plot was used to control the photo plots, as well as to obtain ground information.

Each forested photo plot was carefully studied in three dimensions by the photo interpreter. Forest types were identified; tree height was measured with parallex wedge; crown density with density scale; crown diameter with a micrometer. Stand volume class was thus determined. Forest types are classified as follows:

Conifer types: Spruce and fir;
Hemlock;
Cypress;
Pine;
Other conifers.

Conifer: Hardwood types.

Hardwood types: Tropical hardwoods;
Sub-tropical hardwoods;
Temperate hardwoods.

Bamboo types

Stand density classes are classified as:

Poorly stocked: Crown density, 10 to 39 per cent.
Medium stocked: Crown density, 40 to 69 per cent.
Well stocked: Crown density, 70 to 100 per cent.

Volume classes are shown in the following table, by average volume per hectare, in cubic metres:

Code of volume class	Cubic metres per hectare
00	00—49
05	50—99
10	100—149
15	150—199
20	200—299
30	300—399
40	400—499
50	500—749
75	750+

The sampling errors of the total forested land area and the total volume in Taiwan are given as a percentage of their respective totals for forested land area and volume, namely, ± 1.5 and ± 1.6 .

¹ The original text of this paper, submitted by China, appeared as document E/CONF.36/L.63.

INTENSIVE FOREST MANAGEMENT PLAN SURVEYS

Intensive forest management plan surveys were made for national forest working circles or other specific areas. Their objective was to provide necessary information for the compilation of forest management plans. Surveys were carried out using aerial photographs taken by the Chinese Air Force at scales of 1:10,000 to 1:20,000 with panchromatic or infra-red film and sometimes with minus blue filter.

The stratified sampling method was applied to these surveys. The total forested land area of each working circle or specific area was classified by volume class or stand size class. Ground plots were chosen at random from each class, with an average area of one square kilometre for each plot.

Within each plot, the merchantable length, d. b. h., rough and rotten cull of each sample tree were measured. Reproduction was tallied on specified plot sheets; the stand size, stand density and forest type were also recorded for each plot.

TA-SHUI-SHAN LOGGING AREA FOREST RESOURCES SURVEY

The objectives of this survey were to prepare a topographic map of the Ta-shui-shan logging area at a scale of 1:10,000, to yield reliable timber volumes and their location and to ensure proper management of forest resources.

The aerial photographs were taken with a six-inch focal length lens, minus blue filter and panchromatic film, on scales of 1:18,000 to 1:26,000. Contour maps with five-metre contour intervals were prepared and the forest types delineated. Type data and timber volumes were obtained from 784 field sample plots taken at random in an area of 59,864 hectares. The sampling error was approximately ± 9.11 per cent.

WINDBREAK AERIAL SURVEY

The objectives of this survey were (1) to obtain an accurate inventory of the coastal windbreaks as a necessary basis for management planning, and (2) to determine the amount of windbreak planting still required, and the amount of land that may be reclaimed from the beaches by progressive planting.

The photographs were taken with a lens having a six-inch focal length, minus blue filter and panchromatic film, on scales of 1:25,000 to 1:20,000. The photos cover an area ten kilometres wide along the west coast of the main island.

The photos were carefully studied, and from them land use types were identified and stand height of windbreak and crown density were measured by use of the parallax wedge and density scale. Age classes were checked in the field, and all the information was then transferred to the basic contour map and printed on tracing paper. The area of each forest type will be calculated by the "dot count" method.

TAIWAN "7 AUGUST" FLOODED AREA DAMAGE SURVEY

On 7 August 1959, intensive rainfall caused a disastrous flood in west-central Taiwan. Huge areas of cropland were damaged. To facilitate and expedite the rehabilita-

tion works, a reliable survey of the flooded area was found imperative. The Joint Commission on Rural Reconstruction secured the co-operation of the Agricultural and Forestry Aerial Survey Team, the Chinese Society of Photogrammetry, the Taiwan Provincial Hydraulic Bureau and the Taiwan Forest Administration in conducting this aerial agricultural survey of the flooded area.

The survey started in early October. Photographs were taken by the Chinese Air Force at scales of 1:20,000 with six-inch lens, panchromatic film and minus blue filter.

Damage and land use conditions were first interpreted by comparing the aerial photographs taken after the flood with those taken before it. The damage boundaries were tentatively delineated on the photographs and were then firmed by field examination of the flooded areas.

Damage and land use conditions data were transferred from the photographs to tracing paper by use of radial planimetric plotters and sketchmasters.

Areas were determined from the maps by the "dot count" method.

Control mosaics were made for major watersheds which show the land use conditions before and after the flood.

This project was completed in December 1959.

SEA COAST TIDAL LAND RECLAMATION SURVEY

Along the west coast of Taiwan there are about 600 square kilometres of tidal land which may be reclaimed for settlement. Part of the tidal land was mapped by the aerial photogrammetric method in 1958. Observations were made on the difference of high-tide and low-tide locations. Aerial photographs at scales of 1:10,000 are taken in the spring and winter of each year to make a record of changing conditions of the tidal land. These data are essential for planning drainage systems, dike constructions and forest plantations, which are essential in tidal land development. In the compilation of data, much time, manpower and material expense have been saved by the use of aerial survey methods. Completion of this survey project is expected in 1963.

WATER RESOURCE RECONNAISSANCE

In Taiwan, coal resources are not abundant and their distribution is restricted to the northern part of the island. River and streams, however, are numerous and have steep gradients. Therefore, the development of hydroelectric power remains the main source of energy for the future. Since most of the mountainous region in Taiwan is covered with dense forest, aerial surveying has proved to be the best method of mapping the watershed areas. At present, the greater part of the main watersheds on the east and west sides of the island have been photographed at scales of 1:10,000 to 1:20,000. Some stereograms have also been derived in these areas. Many hydraulic engineers now accept air photos as indispensable tools for their field work. The sites of some reservoirs have been mapped from air photos at scales of 1:5,000 to 1:10,000. It is estimated that the aerial reconnaissance of the water resources of Taiwan will be completed within the next three years.

LIMITATIONS ON THE APPLICATION OF PHOTO-INTERPRETATION¹

Background paper submitted by Thailand

Comparison of different ground objects, whether natural or cultural features, with the aid of aerial photographs is a relatively recent innovation in such fields as agriculture and geology, as well as other technical endeavours. Most of the aerial photographs in Thailand have been taken within the past ten to fifteen years; but aerial photographs have come into general use only within the past three to five years. Judging from the use of aerial photographs by the different branches of the Government, it seems that the need for them is sharply increasing. The government departments which are actively using aerial photographs at present are the Mapping Department of the Ministry of Defence, the Forestry, Rice, Irrigations and Agriculture Department of the Ministry of Agriculture, the Department of Lands of the Ministry of Interior, and several others.

In spite of the many government offices which wish to have their work facilitated with the aid of aerial photographs, there are a number of difficulties encountered by many of the users.

(1) There are still many sections of the country where maps have not yet been prepared from aerial photographs.

(2) In making maps from aerial photographs without using control stations, there will be mistakes and aberrations, especially when the area covers several thousand hectares.

(3) Maps have been made from aerial photographs which are ten to fifteen years old, but in a number of places many changes have already taken place since the photographs were taken, such as the construction of roads, the creation of towns and villages, and changes in the forest areas. Ten to fifteen years ago many regions of the country shown on the photographs were extensive expanses of verdant forest. Only a few rice paddies were noted on the photographs. This year, the results of a joint survey of forest reserves showed that only about 30 per cent of the former forest area remained, while the rest had been taken up by farm lands. The farmers have found that the newly opened land gives very high crop yields without any effort put into weeding because for the first two years newly opened lands are usually without weeds. Weeds usually become abundant in the third year and increase in the fourth, and so on, until the

farmers can no longer cope with the weeding operations. Fertility rapidly decreases and the land is unproductive after the fourth year. In this shifting type of cultivation, the fields are usually discarded after the third year and new forest land has to be opened. Thus, a farmer has to clear the forest for fresh farm land every three years. In fifteen years he will have had to abandon his land five times and every time clear forest area for new farm land. On the aerial maps we can see that the land being cleared is advancing into the inner forest, usually from all sides. Only rocky spots or steep slopes may stop the advance of the destruction done to virgin forests. Most of the present cultivated land is located in the forest reserves, but has been subjected to the jurisdiction of the Royal Forestry Department. It is an alarming situation, for the forest reserves, hundreds of years old, have become farm lands within the past fifteen years, as shown by the result of land co-operative surveys. The survey in its six-year programme will undoubtedly show more such changes. The new aerial photographs to be taken for ground survey parties will show a big difference from the aerial photos taken ten to fifteen years ago.

(4) In joining the photographs from contact prints of 1:40,000 scale for making base maps, the edges of the adjacent photographs do not usually match.

(5) In the absence of differences in the shades of colour on the bare ground or of the vegetation in aerial photos, it is difficult to make delineations of soil boundaries.

(6) Since small intermittent streams often follow old cart tracks, some difficulty arises as to which of the two should be represented by a conventional sign.

(7) The present contact prints of aerial photos having a scale of 1:40,000, when used with the 1:50,000 maps, have shortened the time for making a soil survey by about one-third to one-fifth, especially on agricultural lands that have been in existence for the past ten to twenty years.

(8) Complex slopes of from 0 to 5 per cent or from 6 to 10 per cent are not easily discernible on vertical photographs even with the use of pocket stereoscopes.

In spite of some of the limitations in the use of aerial photos for interpretation of land characteristics, it is always satisfying to have them for making ordinary base maps.

¹ The original text of this paper appeared as document E/CONF. 36/L.18.

TOPICAL INTERPRETATION FROM AERIAL PHOTOGRAPHS¹

Background paper submitted by Thailand

The following table gives details of the aerial photographs used in Thailand for soil survey and land use planning.

<i>Scale and purpose of photography</i>	<i>Type of photography</i>	<i>Time</i>	<i>Season</i>	<i>Type of photographic coverage</i>	<i>Type of print</i>	<i>Direction of flight strips</i>
1:40,000 For reconnaissance soil survey	Vertical, taken by multiple-lens camera	<i>On level land:</i> 8:30-10:30 <i>On slopes facing west:</i> 14:00-16:00 <i>On slopes facing east:</i> 8:30-10:00 <i>On slopes facing north or south:</i> 8:30-10:30	January to March	Stereoscopic	Contact	N-S or S-N
1:20,000 For semi-detailed soil survey	—ditto—	—ditto—	January to March	Stereoscopic	Contact or enlargement	N-S or S-N
1:2,000 For soil conservation survey and land use planning	Vertical, taken by single-lens camera	—ditto—	January to March	Single	Enlargement	N-S or S-N

¹ The original text of this paper appeared as document E/CONF.36/L.68.

BASIC TECHNIQUES USED IN PHOTO-INTERPRETATION AND SAMPLING¹

Background paper submitted by Thailand

Compared with temperate forests, tropical forests offer more complicated problems in photo-interpretation because of the variety of forest types and tree species occurring in them. The methods or techniques used in the west cannot be applied directly in dealing with tropical forests. The use of aerial photographs in forestry in Thailand is comparatively recent, having been introduced only about a decade ago.

At present, aerial photographs are being used in forest inventory only on large-scale surveys. It is out of the question to determine the stock of the stand or identify the tree species directly from aerial photographs because even in each particular type of forest, there are numerous tree species which cannot be seen on them. At most, a qualified interpreter can only differentiate the various types of forests and other classes of land use.

On a large-scale forest inventory, for the purpose of assessing the condition of forests, topography and communications, a special method and technique of sampling have been developed. From the statistical as well as the economical viewpoint, it has been found expedient to keep the percentage of cruise as low as possible in order to evaluate the growing stock of the stand per unit area

with a result within the limited standard error. The sampling area is somewhere near 0.1 to 0.5 per cent, which is accepted as a reasonable degree of intensity. In using the minimum sampling area to evaluate the growing stock, the extent of each particular forest type should also be considered. It is obvious that if the terrestrial survey alone were relied on, the extent of the error in forest areas would be above the acceptable limit. Application of the sampling method by the use of aerial photographs proved to be a better means. The combination of aerial photograph sampling and terrestrial sampling, however, would provide the best method and would help save a great deal of time.

Aerial photographs of the country which are produced especially for topographic mapping purposes can be obtained from the Royal Thai Survey Department. There are no photographs taken especially for forestry work, and there has consequently not been much development in the field of photo-interpretation.

The aerial photographs available are on scales and of types which are somewhat inappropriate for use in forestry work. Neither have they been taken in the proper season, when the characteristics of the various forest vegetation would be readily discernible. The scale, for instance, is rather small, being on the order of from 1:40,000 to 1:50,000. The photographs were taken at the

¹ The original text of this paper appeared as document E/CONF.36/L.81.

beginning of the dry season, which is best for general flying, but the teak stands on the photographs taken during the dry season are not discernible; teak could have been recognized easily if the flying had been carried out in the rainy season, when the teak trees are in flower. There is a significant difference between the growing stock of a forest which is of a mixed deciduous type *with teak* and that of a mixed deciduous type *without teak*, which would have shown up if the photographs had been taken at the proper period.

The appropriate scale of aerial photography for use in forestry work should be about 1:15,000 or 1:20,000, so that all details can be seen fairly clearly and the vegetation easily recognized. It would then be possible also to

identify some tree species. More progress in photo-interpretation, as far as forestry is concerned, would be achieved if the photo scale had been given due consideration before flying.

Normally, photo-interpretation is done on vertical photography using stereoscopes. The interpreter has a three-dimensional view of the terrain photographed, from which he records and classifies the forest types and other categories of land use. Sometimes it is rather difficult to determine the forest types correctly, in which case oblique photos may be very helpful in the interpretation. For the time being, however, oblique photographs are not available; it is hoped that steps will be taken in the near future to make good the present deficiency.

PHOTOGRAMMETRIC SURVEYS FOR NAUTICAL CHARTING—USE OF COLOUR AND INFRA-RED PHOTOGRAPHY¹

Background paper by Captain L. W. Swanson, Chief, Photogrammetry Division, United States Coast and Geodetic Survey

ABSTRACT

One of the principal functions of the Coast and Geodetic Survey is to provide nautical charts of the 2.5 million square miles of coastal waters of the United States and its possessions, and the Commonwealth of Puerto Rico. Photogrammetry has become a recognized method of production, maintenance and revision for these charts. Our photogrammetric procedures have been developed over the past thirty-odd years using nine-lens and single-lens photography to perform aerotriangulation, to prepare detailed large-scale maps and to correct the aids, landmarks and land features. Our first colour photography was taken two years ago and exceeded our expectations in the amount of detail available which could not be seen on panchromatic photography. The colour photography is now used to locate aids to navigations, to position channels and shoals, rocks awash and slightly submerged rocks, and small inlets that shift and change with storms. We are looking forward to the time when colour emulsions on low-shrink film base and a means of making colour diapositives will be available. The present plotting equipment is not satisfactory for use with the existing colour transparencies. We are experimenting with improvements for our instruments to enable us to use the colour transparencies and we have prepared black and white diapositives directly from the colour transparencies for use on the Kelsh plotter. Infra-red photography is also in use to give us the strong contrast between water and land areas for more exact determination of shorelines.

Using colour aerial photography for chart making will probably seem a bit strange to the surveyor and downright queer to the mariner—but we are finding that it provides an "all-seeing" eye for the detection of detail and an extremely valuable accessory for the maintenance of up-to-date nautical charts.

The purpose of this paper is to tell briefly about the advantages of colour for certain phases of chart making. However, in order to provide a background for my subject, I must digress a bit to tell you about one of our particular, and perhaps rather unique, charting problems.

¹ The original text of this paper and those of the following three papers were submitted by the United States of America and appeared together as document E/CONF 36/L 52.

One of the principal functions of the Coast and Geodetic Survey is to provide nautical charts of the 2.5 million square miles of coastal waters of the United States and its possessions, and the Commonwealth of Puerto Rico. This requires the publication and maintenance of about 820 individual charts. This is quite a sizable area but size alone is not the principal feature.

We are favoured with many bays and harbours and extensive intra-coastal waterways—particularly along the Atlantic Coast, the Gulf of Mexico and in Alaska; all in all, a shoreline totalling over 100,000 miles and thousands of miles of protected or intra-coastal waterways that require the greater portion of the 16,000 fixed aids (lights and day beacons) and 24,000 buoys that are maintained for the mariner. As a consequence, over 80 per cent, or about 670 of the 820 charts are published at scales of 1:40,000 or larger for navigation in these more or less restricted intra-coastal waters, where the navigator is relatively close to land, where shoals are often extensive and the channels intricate, and where frequent reference must be made to landmarks, to lights and buoys, and to features of the nearby land.

We hold that a nautical chart is an instrument of navigation that must be kept up to date to serve its intended purpose, i. e., to ensure the safety of navigation. The larger part of our charting effort is devoted to maintenance, particularly the maintenance of the considerable number of large-scale charts. For example, in 1960 we published only thirteen new and reconstructed charts but we revised and reprinted 440 charts, or over 50 per cent of the total number of charts on issue.

It is against this background of large-scale charts with their requirement for frequent revision that our photogrammetric procedures have been developed over the past thirty-odd years. We use nine-lens and single-lens photography together with limited ground surveys and stereoscopic plotting instruments:

1. To perform aerotriangulation, to position landmarks and aids to navigation, to provide alongshore control points for inshore hydrography, and to position individual models for map compilation;
2. To prepare detailed large-scale maps showing the shoreline, along-shore rocks and structures, indications of shoals and channels visible in the photographs, and

the land features adjacent to the shore. These are prepared ahead of hydrography for the guidance of the hydrographer and are used together with the hydrographic survey for the construction or revision of the chart;

3. To correct the aids, landmarks and land features on chart drawings directly from new aerial photography to bring this information up to date just prior to reprinting and reissue of the chart.

We took our first experimental colour photography just three years ago, in connexion with an unusual shoreline mapping problem and were amazed and delighted with its ability to record, and to separate details not seen on panchromatic film. The amount of field work required in our photogrammetric mapping is generally in inverse ratio to the clarity with which certain features, such as landmarks, lights and beacons, rocks awash and inlying shoals and channels, can be seen and identified with certainty on aerial photographs.

In this respect, colour photography is saving us time and money and giving us more up-to-date charts. It is already in general use in the Coast Survey as a supplement to our usual panchromatic mapping photography.

We are using and beginning to use colour photography:

1. To identify and locate aids to navigation;
2. To map the topography of uneven bottom in shoal waters to assist the hydrographer in developing and weeping these areas;

3. To map alongshore rocks awash and slightly submerged rocks in places where these are close to traffic lanes and for any reason difficult to develop in detail by sounding;

4. To investigate changes in shoreline and entrance channels at inlets and frequently to revise these features;

5. To assist the Coast Guard in the investigation of accidents involving aids to navigation reported missing or out of position.

One of the principal uses of colour aerial photography is to locate lights, day beacons and buoys moved by storms or collisions, so that the charted positions can be corrected. The charts can also be kept up to date by showing cultural changes from the colour photographs without the necessity of a field examination.

The virtue of colour photography lies in the fact that it is usually possible to identify and locate the aid by office examination of the photographs and office plotting without a trip to the field. Formerly, we had to locate these by ground survey, or visit the area to identify them on panchromatic photography, or target the aids prior to panchromatic photography, each a costly and time-consuming task.

As I mentioned before, there are some 40,000 aids—most of them in the bays, harbours and intra-coastal waters—and a large proportion of them are subject to change: buoys and single-pile structures are moved by ice, or,

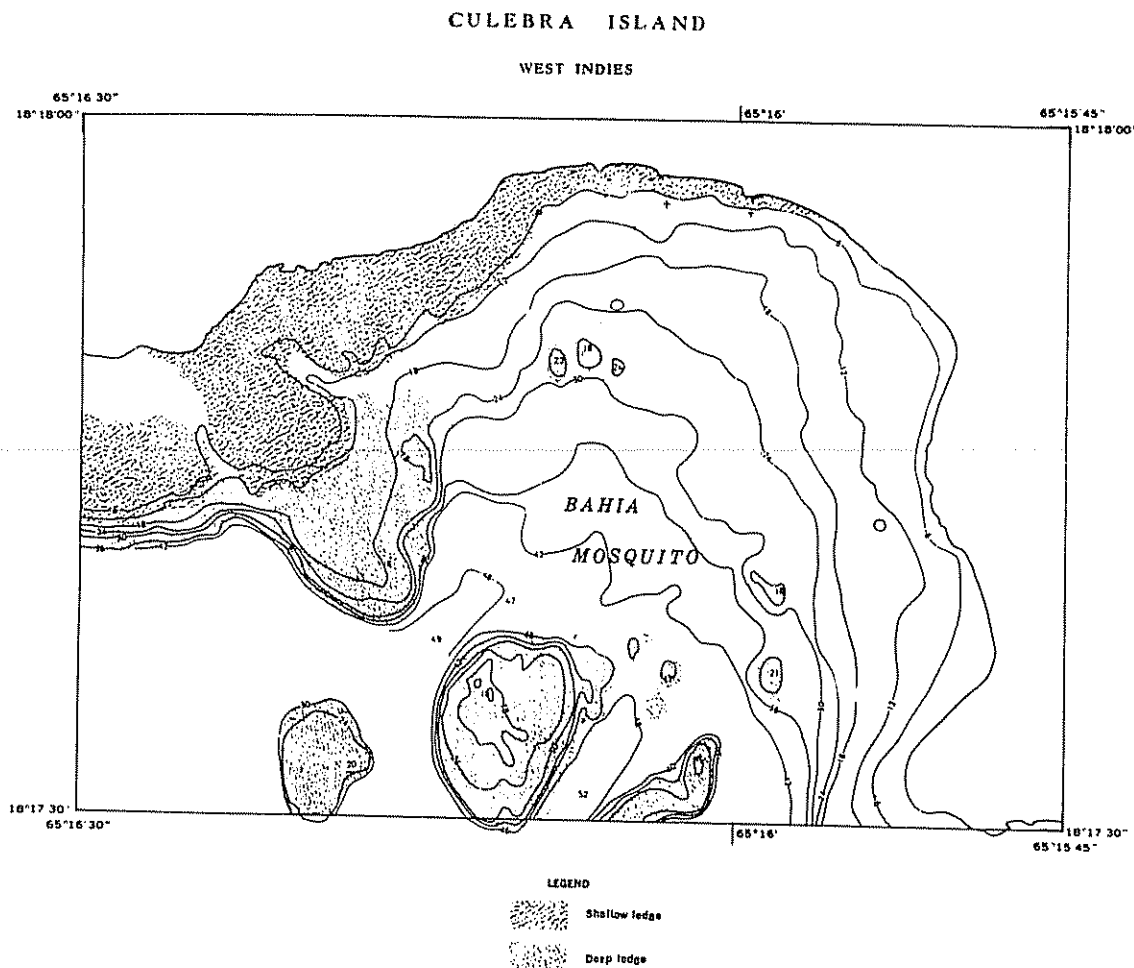

Figure 92. Bottom topography drawn from colour photographs by Kelsh plotter

not too infrequently, knocked out by passing vessels; and channels and shoals are changed by the work of both man and weather.

We have been able to see the bottom, that is, to penetrate the water, with colour photography to depths ranging from eight to ten feet in Alaska to sixty and even seventy feet over the coral bottom in certain parts of the Caribbean. At this time, we are compiling bottom topography of an area off the coast of Puerto Rico and the Virgin Islands preparatory to hydrography. Bottom features are clearly visible on the colour photography of this area. Depths measured on the Kelsh plotter and corrected for refraction, when compared to prior hydrography, appear to be correct to plus or minus 5 per cent to maximum depths of seventy feet.

Figure 92 shows the bottom topography drawn from the colour photographs by Kelsh plotter. This is a section of a preliminary or reconnaissance map prepared as a guide for the hydrographer. Depths are approximate but the relative positioning of shoals, channels and other submarine features is quite good. This information will be transferred to the boat sheet, or hydrographic work sheet, prior to hydrography and will indicate to the hydrographer the bottom features that require special development and also the maximum settings of the wire drag or sweep, in any given area.

This same information and the colour photographs will also assist in the shaping of depth curves during the smooth

plotting of the hydrography. In fact, the colour photography will sometimes permit us to complete depth curves in shoal waters that were not completed by the hydrography. As an example, figure 93 A shows an area between Great St. James Island and Little St. James Island where during prior surveys no hydrography was done because of the difficulty of entry. The depth curves in this passage shown on figure 93 B were completed solely from colour photography.

Along much of our coastline the depth of penetration by colour photography will not be so great as in the area just illustrated. However, there will be many instances where colour photography of bottom features to depths of but a few feet will be extremely helpful.

It is always helpful to position channels and shoals on the boat sheet prior to hydrography. We have always done this in so far as practicable on the maps that we prepare for the hydrography, but our panchromatic photography left much to be desired. Colour photography clearly shows the limits of channels and the extent of shoals.

Rocks awash and those slightly submerged at low waters are particularly important when close to traffic lanes and it is not always easy to locate these features either by photogrammetry with panchromatic photography or by sounding. Colour photography providing some penetration of the water is extremely helpful for this purpose.

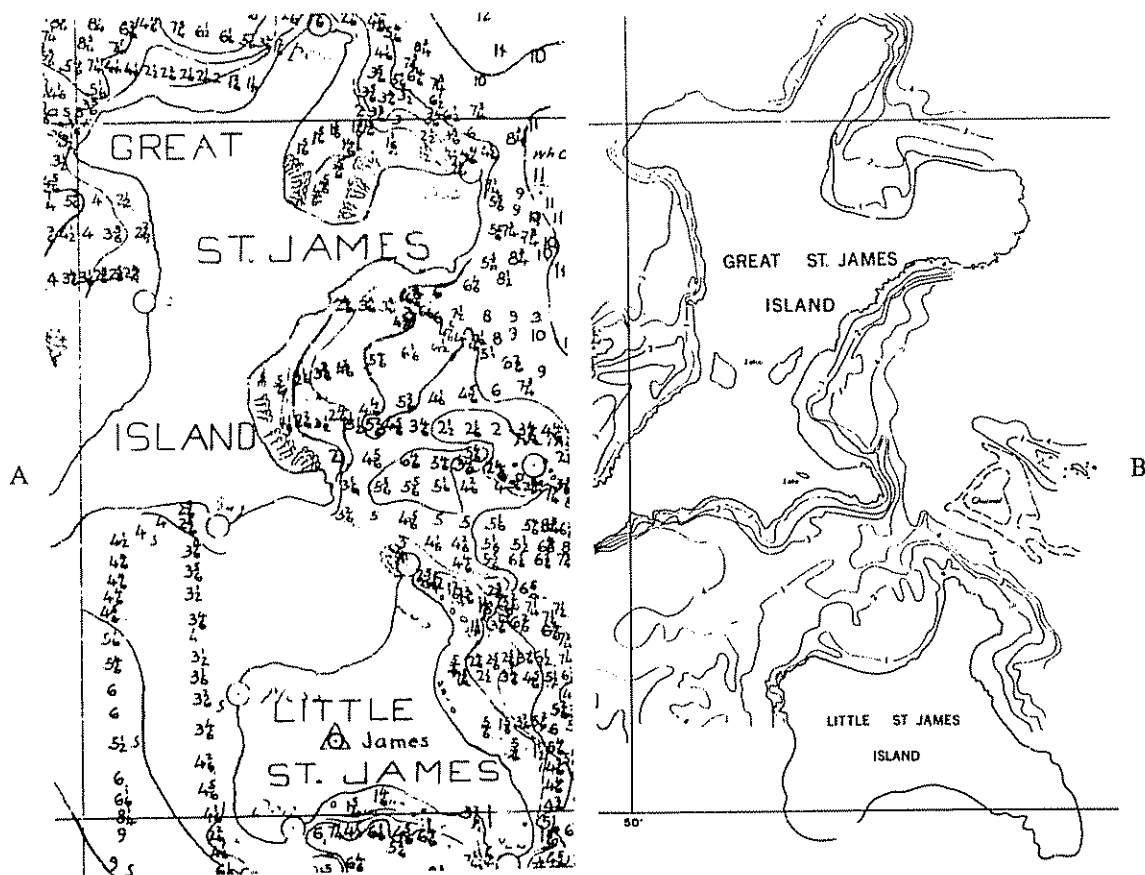

Figure 93. Sketch maps showing the difference in the hydrography of an area before (A, left) and after (B, right) the use of colour photography

We have many small inlets that shift and change with storms. We customarily revise the shoreline after such changes from panchromatic photography, and this is done quickly and readily. However, hydrography to detect changes in the channels at such inlets is a slower, more tedious job. Colour photography will often detect the fact that a channel has changed position and show the new position even though it can give us, thus far, only approximate information about the depth.

Our methods of plotting with colour photography are thus far quite crude. We are using colour transparencies. These are cut to individual photographs for stereoscopic viewing on a light table. When locating aids to navigation, radial templates are made on a light table and plotted to passpoints located by photogrammetric bridging with higher-altitude panchromatic photography.

Colour emulsions are not yet available on glass plates for plotting instruments. Consequently, we had to adopt an expedient that works quite well. We make contact prints from the colour transparencies on to glass plates using the same emulsions ordinarily used for black and white diapositives. The result is a black and white diapositive with reversed tone. These emulsions happen to be blue sensitive and since the water areas are predominantly blue in tone they retain the depth penetration quality of the original colour transparencies and are

quite satisfactory for compilation of bottom topography on the Kelsh plotter.

We look forward to the time when we will have colour emulsions on a low-shrink aerial film base and means of making colour diapositives for use in stereoscopic plotting instruments, but we have not yet received much encouragement from industry and this seems to lie well in the future.

In closing, I want to mention our use of infra-red photography. For some years now we have found it to be an extremely helpful adjunct for mapping the shoreline. This is particularly true when we want an exact mean low-water, or mean high-water line or for that matter any shoreline contour. For charting purposes, the shoreline is the approximate mean high-water line which we customarily map using panchromatic photography which has been taken in the field to identify the shoreline by examination on the ground. However, a more exact delineation of the shoreline contour is occasionally necessary, and in such cases, we co-ordinate the photography with tide staffs and take infra-red photographs at, or very nearly at, the exact stage of the tide. The contrast between land and water is strong, so that the shoreline (high-water line, low-water line or any shoreline contour) can be accurately mapped with little or no field examination.

PRELIMINARY REPORT ON THE USE OF AERIAL PHOTOGRAPHS IN FOREST INVENTORIES¹

Background paper by the Forest Service, United States Department of Agriculture

INTRODUCTION

In 1959, a committee was formed under section 25 of the International Union of Forest Research Organizations with the purpose of studying the use of aerial photographs in forest inventories and recommending standard applications and further research in techniques. This paper covers part of the progress report made by that committee in September 1961 to the Thirteenth Congress of the International Union of Forest Research Organizations in Vienna, Austria. It gives the committee's preliminary list of useful applications of aerial photography to forest inventories. Another part of the progress report gave a preliminary list of current research studies to increase the efficiency of applying aerial photography to forest inventories.

PRELIMINARY LIST OF AERIAL PHOTO APPLICATIONS TO FOREST INVENTORIES

A. *Aerial photographic techniques*

1. For compiling forest base maps (planimetric or topographic), photo scales of 1:30,000 to 1:50,000 taken with a focal length of six inches are generally preferred.

2. For classification and mapping of such area classes as cover type, stand volume, stand size, crown close danur physiographic site, photo specifications vary with forest regions.

(a) In temperate forests of North and Central America and Europe, stereoscopic vertical photography (with 60

per cent forward lap and 30 per cent side lap) using panchromatic film and minus blue filter, taken in summer (e. g., in North America, May through September) within two or three hours of noon is generally used. A negative size of 9 × 9 inches, negative scale of approximately 1:15,840 to 1:20,000 and a focal length of 8¼ inches are also generally used;

(b) In mixed spruce-fir and aspen-birch forests of North America, the application in (a) is sometimes varied by using an infra-red film and minus blue filter (to give contrasts between softwoods and hardwoods and between well-drained and poorly-drained sites);

(c) In western parts of North America (where tall timber and steep topography is common), application as in (a) is recommended but with use of a negative scale of about 1:12,000 to 1:14,400 and a twelve-inch focal length (to avoid parallax of such proportions as to be annoying when viewing stereoscopic images of tall timber);

(d) In Australia, application as in (a) is recommended, but with summer photography at a scale of 1:15,840 and focal lengths of ten or twelve inches preferable. More care is also taken in orienting flights to avoid shadow point (hot spot) (1) (2);²

(e) In Great Britain, application as in (a) has been used but with scales of 1:10,000 or 1:20,000 and focal length of from six to thirty-six inches;

(f) In central Europe, application as in (a) has been used. A scale of photography of 1:10,000 is generally preferred and necessary where large-scale forest base maps (e. g., 1:5,000 or 1:2,500) are required;

¹ This paper has been adapted from a report to the International Union of Forest Research Organizations (IUFRO) made by a committee listed at the end of this paper.

² The figures in parentheses relate to the references at the end of this paper.

(g) In tropical regions (e.g., India, Pakistan, Thailand, Ceylon, Federation of Malaya and parts of Africa), photos at scales between 1:30,000 and 1:50,000 with focal lengths of six inches have been used, although limited coverage at 1:15,000 has been used (3), (4), (5), (6).

3. For interpreting such details of forest or tree conditions as incidence of attacks by tree insects and diseases and for species identification in the United States, several photo specifications have been used.

(a) Stereoscopic vertical colour photography taken at a season varying with the incidence of the particular pest (generally summer) within two hours of noon is recommended generally. Negative sizes appreciably smaller than 9×9 inches and negative scales larger than approximately 1:8,000 (up to 1:1,000 or larger) are useful;

(b) Black and white (generally panchromatic) vertical photography is useful but less so than colour is;

(c) Low-altitude oblique photography is also useful, particularly as a supplement to applications in (a) and (b).

B. Photo-interpretation equipment and aids

1. Direct vision stereoscopes are used most for interpreting general forest conditions. Greater use of scanning stereoscopes (such as the Old Delft) is recommended for detailed interpretation.

2. Aerial stand volume tables are used to some extent in Canada and the United States and are in more limited use in Australia as aids in stratifying forest by gross volume classes. Total measurable height and crown closure are generally recognized as the most useful variables in stand volume tables. From tropical rain forests the most useful tables may be those based only on crown closure.

3. Keys for identifying tree species or other forest details have been used in Australia and to a less degree in North America. They have proved most useful where photography has been taken to uniform specifications over rather large areas.

4. Relatively simple and inexpensive devices are used for making most photo measurements or estimates needed for forest photo-interpretation. For example, parallax wedges and parallax bars (or stereometers) used under lens stereoscopes serve essentially as well as elaborate stereo plotters for making measurements of images of tree or stand heights. Other commonly used aids for interpretation of temperate forests are dot grids for estimating areas, and scales for estimating crown coverage or density and crown diameter. Crown diameter scales are also used to some degree for photo-interpretation of tropical forests.

C. Photo-interpretation and associated techniques

1. Sampling designs involving photo plots may be systematic (used in most inventories in the United States and in management inventories in Canada) or random (generally used in Australia and in regional inventories in Canada). Usually templates indicating the desired spacing of plots and desired shape and size of each plot are overlaid on photos.

Interpretation of photo plots provides forest classification which may be used to stratify field plots by gross volume (often used in North America) or by another significant variable such as broad cover type classes [used in Thailand (5)].

Sequential photo sampling (i.e., repeated photo coverages of the same plots) is used in Canada and in the United States on some continuous inventories (re-inventories at rather frequent intervals) together with re-measurements of permanent field plots. This procedure, giving direct comparisons of photo images taken several years apart, is particularly useful in determining changes in the forest due to growth and drain.

Double sampling (paired observations and measurements made on photo and field plots centred over the same ground area) is an efficient procedure for adjusting and refining estimates made by a large number of photo plots and is used in several regional inventories in North America.

The usual size of photo plot is such as to cover no more than one acre of ground area. When scale of photography is fairly large—in excess of 1:10,000—photo plots may be used covering a ground area as small as one-fifth acre. A circular plot has generally been the most convenient shape to use. In all inventory applications where field estimates are used to adjust photo estimates, the photo and field plots should be designed to sample approximately the same ground area. For example, with photography of large timber at a scale of 1:15,840, the smallest desirable photo plot might be one representing one-half acre. If variable-radius circular field plots (angle-gauge or point samples) are desired, one of these may be centred on the point forming the centre of a one-half-acre circular photo plot or a cluster of several field plots may be centred around the same point.

Field plots generally used to sample stand classes stratified by photo-interpretation are: in Canada, one-fifth or three-tenths-acre rectangular plots or clusters of four one-tenth-acre circular plots; in Australia, one-acre rectangular plots for indigenous forests and one-tenth or one-fifth-acre plots or angle-gauge samples for exotic plantations; in the United States, one-quarter or one-fifth-acre circular plots or angle-gauge samples of the basal area factor appropriate to the forest type. In some inventories of tropical forests, clusters of small circular plots (of less than one-fifth acre) have been recommended. For example, in an inventory of Thailand, concentric plots of 0.01 ha and 0.05 ha arranged along lines forming a large rectangle, or "tract", were used (5). In other surveys in the tropics, sampling strips (with 100 per cent enumeration of most valuable stands) have been used (4).

2. Photo-interpretation of the following information is done with accuracies that vary with the quality of the photography, the complexity of the forests and the experiences of the interpreter: land use class, tree species, forest cover type, physiographic site, stand volume and stand age classes and damage or infestation classes (caused by such agents as forest insects, diseases and fires). Interpretation of such items is generally proving to be more difficult on photos of tropical forests than on photos of temperate forests.

3. Photo measurements or estimates of the following items of information are feasible using the techniques indicated.

Distances are measured using engineer's scales graduated either in 50ths or 100ths of an inch. Short distances are also measured with micrometer line wedges graduated in 100ths of an inch. Transparent conversion scales or wedges are also used. These permit readings on photos directly in equivalent ground survey units (e.g., in chains or feet) for each scale in a range of scales of photography.

Angles are measured between images on photos (to determine directions between objects on the ground) by using transparent photo protractors graduated in degrees. To minimize error caused by relief displacements in mountainous areas, a base line for turning an angle is selected that lies essentially in the same datum as that of the point to which a bearing is sought. The base line is also preferably chosen to be reasonably close to the point in question and near the centre of the photograph.

Areas of forest classes are measured generally by intensive dot counts, square counts or line transects, using templets overlaid on photos or on maps to which boundaries of areas delineated on photos have been transferred. Although the polar planimeter is also used for measuring areas shown on maps, the relatively small gains in accuracy by this laborious method over methods mentioned above are not considered sufficient to justify its use for most forestry purposes. Sampling with photo plot templets directly on photographs is also used for estimating areas when forest classes are not delineated. This procedure gives reasonably accurate results even on photos of areas of high relief when precautions are taken to minimize bias due to variations in scale of photography.

Slopes of terrain are usually determined by measuring parallax differences with a parallax wedge, stereometer or stereoplotting instrument. Sometimes a slope percentage scale is used to convert elevation differences into slope percentage without computation.

Crown closure is generally estimated ocularly in percentage classes with occasional checks made by comparing images of stands with crown density scales (estimating guides). Greater use of measurements of crown closure by such devices as intensive dot grids and line transects is recommended.

Tree and stand heights are determined generally by parallax measurements made with parallax wedges, stereometers or parallax bars; occasionally they are determined from measurements of shadows or displacements of single images made with micrometer wedges.

Tree crown diameters are measured either with micrometer (line) wedges or dot-type wedges.

4. Transfer of delineations from photos to base maps is usually by such instruments as sketchmaster, microscope, stereotope, stereomicrometer or radial-line plotter.

D. Photo-interpreters

(a) Selection of interpreters is generally on an informal basis although increasing numbers of recruits are selected from forest school graduates who have had courses in photo interpretation. Some agencies (including government departments in Australia) give stereovision tests and related tests of PI aptitude as a partial basis for selection (7), (8);

(b) Training of most interpreters is on-the-job although a number of forest schools—in Canada, the United States and Australia—give regular courses and intensive short courses in photo-interpretation and photogrammetry. The International Training Centre for Aerial Survey at Delft, the Netherlands, also gives a course in forest photo-interpretation.

E. Visual reconnaissance to check PI

Field observations to verify or correct forest photo-interpretation are generally made on the ground, often

during the course of travel between field plots. Visual checks from low-flying and slow-moving aircraft have also been effective in Canada and other areas, particularly to check land use class, cover type and species composition. Visual checks of stand sizes or tree sizes are not as effective from moving aircraft. Careful planning is essential for efficient visual checking regardless of the mode of travel.

F. *General inventory designs using aerial applications to aid in determining areas of forest classes and volumes, growth and drain of timber*

1. *Double sampling by photo and field plots to estimate all statistics*

(1) Photo plots systematically located over aerial photos are interpreted to provide area estimates of land use and forest condition classes and to provide a basis for stratifying field plots by gross volume or other class. (2) A relatively small number of field plots is randomly or systematically selected from the photo plots falling on forest land. Estimates are made on all field plots to determine details of forest classes and timber and these data are used to adjust estimates made by photo plots and to provide estimates of other items such as detail on quality, defect and mortality of the timber not obtainable by photo-interpretation.

Double sampling as applied to human populations was described by Neyman in 1938 (9). The application to tree populations was described by Bickford in 1952 (10). The method as applied to forest inventories is described in several books. *The Manual of Photo Interpretation* (11) gives procedures for determining optimum relative numbers of photo and field plots to be taken. Procedures for adjusting photo estimates by field estimates are also given in the same publication, and are discussed briefly in section 19 of the *Forestry Handbook* (12) and in chapter 26 of Spurr's *Forest Inventory* (13). The design permits rapid inventories at reasonable costs and computation of confidence limits for statistics, although the planning and computing phases are rather complicated. It is used in parts of the United States and Canada on regional inventories.

2. *Triple sampling by photo and field plots to estimate all statistics*

(1) Photo plots (located as in double sampling) are interpreted to provide area estimates of land use classes. (2) A portion of those photo plots falling on forest land is interpreted to provide estimates of forest condition classes and to stratify field plots. (3) Field plots are selected from the photo plots interpreted in step 2, and data from these are used as in double sampling.

References for and utility of this design are the same as those for double sampling. The design is used in parts of the United States on regional inventories.

3. *Photo sampling to estimate land use classes and field sampling to estimate all other statistics*

(1) As in triple sampling, numerous photo plots are taken to obtain a preliminary estimate of land use classes. (2) Field plots are taken in a random or systematic manner from the photo plots falling on forest land, and these are used to adjust photo estimates of land use classes and provide estimates of all other statistics.

References are the *Forestry Handbook* (12), *Manual of Photo Interpretation* (11) and *Forest Inventory* (13). The

design is relatively simple, reasonably flexible and dependable. It tends to be somewhat more costly and slower in operation than the double and triple sampling designs. It is used on some regional and management inventories in the United States.

4. Photo mapping to determine areas of forest classes and sampling to estimate other statistics

(1) Forest condition classes are interpreted and delineated on aerial photos and are checked in the field as necessary. Delineations are transferred to base maps and areas of forest classes are determined by planimetry of all mapped units (or by other method of determining areas on maps, such as intensive dot counts). (2) Field plots are generally taken in a random or systematic manner to provide representative samples of each forest class. The data from field plots are the bases for estimating such statistics as species composition, volume and mortality in each forest class. Variations of the design include the empirical selection of locations for field plots, or ocular estimates of "average" statistics for each class and estimates of "averages" derived by photo-interpretation.

The design is referred to in various articles and books, including the *Manual of Photo Interpretation* (11), the *Forestry Handbook* (12), *Forest Inventory* (13) and *Photogrammetry and Photo-interpretation*. It produces a useful map of forest conditions as an integral part of the procedures, but is more costly than the previous designs. Confidence limits cannot be computed as easily as under the previous designs; accuracy of delineation varies with subjective decisions of photo-interpreters and field mappers as they judge the "average" of rather wide ranges in conditions over rather large areas. This contrasts with the greater accuracy of determinations made in classifying small sample plots where the range in conditions is more limited. The design is used on management inventories in North America and in the tropics. A variation used in central Europe is aimed primarily at producing a forest map by photo-interpretation and field checking for use in management planning. Ocular estimates of timber volume are made, which are checked by angle-gauge samples occasionally.

CONCLUSIONS

A major purpose of preparing and distributing this preliminary progress report is to invite suggestions for additions to these lists. In a subsequent report the committee plans to evaluate its findings and present recommendations (or at least separate listings) for procedures which apparently have rather widespread, if not universal, applications. At the same time, attention will be directed to those procedures which appear to be considerably more limited in application—perhaps to some which may be very effective in particular situations and ineffective in most if not all other situations. As an example, on the basis of evidence now available to the committee, it appears that some of the applications of aerial photography and photo-interpretation which have proved successful for inventories of forests in temperate zones do not appear to be effective for inventories of tropical rain forests. Thus, the committee invites comments which will help to appraise the relative suitability of an application in certain geographic areas or for certain inventory purposes, such as for reconnaissance, regional planning or management planning on individual proper-

ties. Suggestions are also invited for needed research studies to increase the efficiency of applying aerial photography to forest inventories. Suggestions and comments may be sent to any member of the IUFRO Committee on the use of aerial photographs in forest inventories listed below:

- | | |
|---|---|
| Dr. D. A. Boon
International Training Centre
for Aerial Survey
Kanaalweg, Delft 3, Holland | Mr. Robert G. Miller
Forestry and Land Use Section
Directorate of Overseas
Surveys
Kingston Road
Tolworth, Surbiton
Surrey, England |
| Ing. Vladimir Cermak
Forest Research Institute
Banska Stiavnica Sub-office
Michalska 24/11, Bratislava
Czechoslovakia | Mr. H. Reichardt
Forestry Division
Food and Agriculture
Organization of the United
Nations
Viale delle Terme di Caracalla
Rome, Italy |
| Dr. D. A. N. Cromer
Division of Forest Manage-
ment Research
Forestry and Timber Bureau
Canberra, Australia | Professor J. H. G. Smith
The University of British
Columbia
Faculty of Forestry
Vancouver 8, B.C., Canada |
| Dr. F. Loetsch
Federal Forest Research
Institute
Reinbek, Lindenstrasse 21,
Hamburg, Federal Republic
of Germany | Mr. R. C. Wilson
(Chairman of the Committee)
Forest Survey Branch
US Forest Service
Washington 25, D.C., USA |

REFERENCES

- (1) W. G. Sims, *Shadow Point*, Leaflet 67, Forestry and Timber Bureau (Canberra A. C. T., 1954)
- (2) Anon., *The Avoidance of "Shadow Point" on Aerial Photographs*, Leaflet 74, Forestry and Timber Bureau (Canberra A. C. T., 1955)
- (3) R. A. DeRosayro, "The application of aerial photography to stockmapping and inventories on an ecological basis in rain forest in Ceylon", *Empire Forestry Review*, 38 (2) No. 96, June 1959
- (4) D. A. Francis, "The use of aerial photography in tropical forests", *Unasylva*, 11 (3), 1957
- (5) F. Loetsch, "A forest inventory in Thailand", *Unasylva*, 11 (4), 1957
- (6) R. G. Miller, "The use of aerial photographs in forestry in British Colonies", Paper to the Seventh British Commonwealth Forestry Conference, 1957
- (7) W. G. Sims and N. Hall, *The Testing of Candidates for Training as Air Photo Interpreters*, Forestry and Timber Bureau (Canberra A. C. T., 1956)
- (8) P. R. Lawrence, "Testing the efficiency of photo-interpretation as an aid to forest inventory", Paper to the Seventh British Commonwealth Forestry Conference, 1957
- (9) J. Neyman, "Contributions to theory of sampling human populations", *Journal of American Statistical Association*, 33:101-116, 1938
- (10) C. A. Bickford, "The sampling design used in the forest survey of the northeast", *Journal of Forestry*, 50:290-292, 1952
- (11) American Society of Photogrammetry, *Manual of Photo Interpretation* (George Banta Publishing Company, Menasha, Wisconsin, 1960)
- (12) Society of American Foresters, *Forestry Handbook* (The Ronald Press Company, New York, 1955)
- (13) Stephen H. Spurr, *Forest Inventory* (The Ronald Press Company, New York, 1952).

AIR PHOTO ANALYSIS IN LAND UTILIZATION RESEARCH

*Background paper by H. W. Dill, Jr., Farm Economics Division, Economic Research Service,
United States Department of Agriculture*

Rapid progress has taken place in recent years in the application of air photo analysis to assist in carrying out land utilization research. Use of air photo-interpretation to aid in the solution of the basic data problem was started in 1955 in the Farm Economics Division, Economic Research Service, United States Department of Agriculture. Since that time, use of air photo analysis has increased in the number of subject matter fields to which it has been applied and also in the development of methods to solve various types of problems. The purpose of this paper will be to review the problem, discuss briefly the subject matter fields and describe the methods developed. Some of the material covered has been described in detail in separate papers over a period of time, but it is hoped that this summary may be useful to those considering the use of air photo analysis in land utilization problems in Asia and the Far East.

THE BASIC DATA PROBLEM

Economic analysis in the field of land utilization depends upon many types of data which are lacking for many areas. Ideally, an up-to-date map showing detailed land use, soil type, topography and many other items would be the best source of data. However, for most areas this type of information is not available and for many studies sufficient time and money are not available to allow for field mapping.

In land utilization research there are three main areas where use of air photo analysis is most appropriate as a source of basic data. The first area of application is in providing data on major uses of land either as compiled data measured from the air photo or as a map showing location and pattern of land use developed from study of air photos. A second is in the study of an area to isolate land use problem situations. For example, a large area can be covered to identify places where land is being cleared, urban development taking place, and so on. Detailed study can then be concentrated on these areas of interest. The third major area where use of analysis can provide data is in the study of changes in use of land. Comparison studies of recent air photos with earlier coverage can provide many kinds of data on changes and trends in land utilization.

The use of air photo analysis in the general fields described above has usually been limited to considering major uses of land or studies of items with distinctive characteristics that can be identified on the 1:20,000-scale contact air photos which are most readily available for use. To provide more detailed information on such items as row crops or grains, large-scale photographs taken at critical periods during the growing season would be needed.

Before describing the air photo analysis methods developed to provide information, specific problem situations in the several subject matter fields where air photo analysis has been used will be discussed briefly.

SUBJECT MATTER FIELDS FOR AIR PHOTO ANALYSIS

Air photo analysis has been used in several fields of land utilization research. The data problem has varied considerably and is illustrated by the problem situations described below. In each of the situations, air photo

analysis supplied acceptable data for economic analysis within the time and fund limitations imposed for the particular situation. The references cited describe the details of the procedure followed.

Flood plain delineation and land use

To study the economic effect of a flood control dam, it was necessary to delineate the boundary of the flood plain and measure the acreage of the different types of land use included. It was also necessary to determine the acreage and types of land use affected by different flood stages, both for the natural conditions and for those prevailing with a flood control dam in operation.¹

Land development

The first use of air photo comparison analysis in the Farm Economics Division was made in a study of the coastal plain in North Carolina. Forest land was being cleared and drained for cropland. Data were needed on the total acreage and type of forest land being cleared, to determine the significance of this development. Information was also needed on the location and size of tracts cleared so that these areas could be visited in the field to study types of equipment used, methods of carrying out work, and the costs and benefits of this type of land development. The study was made for two time periods since three air photo coverages taken at intervals were available.²

Shifts in use of land

Data on changes in use of land were needed for large river basins where agricultural use was changing to urban use and for other areas where farmland was reverting through stages of idle land and brushland to forest.³

Highway construction impact on use of land

A study of the "before and after" situation was needed with reference to changes in land use taking place where major highways had been constructed, particularly on the area around interchanges.

Recreation site location

Data were needed on the number of potential recreation sites and the prospects for future hunting areas in the north-eastern United States. Information was needed on the occurrence of several basic types of recreation sites.

For the above situations, time and funds were limited and the methods described below were developed to provide the best data for economic analysis within the limitations for each problem.

AIR PHOTO ANALYSIS PROCEDURES

The methods used to provide data from air photo analysis include two basic approaches—direct identification from one coverage and comparison analysis using two or more successive coverages taken at intervals.

¹ H. W. Dill, Jr., "Photo interpretation in flood control appraisal," *Photogrammetric Engineering*, v. 21, No. 1, 1955.

² J. R. Anderson and H. W. Dill, Jr., "Land clearing and drainage in eastern North Carolina," United States Agricultural Research Service, ARS 43-127, 1961.

³ H. W. Dill, Jr., "Use of the comparison method in agricultural airphoto interpretation," *Photogrammetric Engineering*, v. 25, No. 1, 1959.

Either of these approaches can be used in three different ways. These include stereo interpretation of contact prints, use of air photo index sheets, or controlled mosaics, and air photo analysis of sample plots.

Direct identification

Our use of direct identification has ranged from studies to delineate flood plain limits to making counts of conventional items, such as houses and barns, and mapping major land use to "best estimates" of less characteristic items. Such items would include land use-soil combinations, potential recreation pond sites and other items where the only source of data is the air photo.

Air photo comparison analysis

For many problems data are needed on the amount and trend of changes in use of land. Where more than one air photo coverage is available, changes in use can be identified by comparing successive coverages flown at intervals. Areas of change can be identified, located, measured and studied in the field to provide data on costs, benefits and so on.

Both basic approaches have been used on three different "scales" depending on the problem. We began our work by using stereo analysis of 1:20,000 contact prints to study flood plain areas. To determine land use changes, land clearing and drainage, we used stereo analysis of 1:20,000 contact prints to study townships averaging about 50,000 acres. While we were able to provide useful data within a relatively short time and save money, there was still need for faster means of providing data for larger areas, such as counties, river basins and other areas delineated for special study. Stereo analysis of contact prints required placing match lines on each alternate print to avoid duplication or missing portions of the study area, both for the analysis and measurement of data.

Use of air photo index sheets

To study larger areas we have used air photo index sheets (1:63,360) to provide many types of data. While these are not controlled mosaics, they are readily available, very reasonable in cost, and, after analysis has been completed, provide a map for field study of changes identified. In some studies we have used photo index sheets to study large areas to locate "possible" areas of land use change to be studied in greater detail by larger-scale stereo analysis. This procedure aids greatly in reducing the area of consideration and concentrates time and funds for purchase of larger-scale air photos on the areas of greatest interest.

Air photo analysis of samples

A third method has been developed recently in which we use air photo analysis on sample plots. Recently in the United States a national sample was designed for the Department of Agriculture for the National Inventory of Soil and Water Conservation Needs.⁴ Co-operative agreements were made by the Department with the Statistical Laboratory at Iowa State University and the Biometrics Unit at Cornell University to select a national sample of land use and soil conditions.

A basic area sampling rate of 2 per cent was determined to be statistically reliable at the county level.

⁴ H. W. Dill, Jr. and K. C. Nobe, "New resource planning data from the national inventory of conservation needs". *Journal of Soil and Water Conservation*, v. 15, No. 5, 1960.

For most of the country, the sample plot size was 160 acres, except for the thirteen north-eastern states, where a unit of 100 acres was used.

The sample plots were identified on individual county maps and the plot boundaries transferred to an air photo base for field mapping and measuring of data. In the field, Soil Conservation Service technicians mapped cropland, pasture and range, forest and woodland, other land use (farmsteads, idle agricultural land, wildlife areas and other non-agricultural) and urban use. In addition, the soil type, percentage of slope and degree of erosion were carefully mapped and annotated on the air photo by appropriate symbols. The field data were measured and tabulated to show the acreage of each combination of land use with soil type, slope and erosion and the land use capability class in which this combination would be included. A separate plot summary was prepared for each sample; the data was expanded to prepare county estimates and then combined into estimates for each state. For the most part, the computing was carried out by using punch cards prepared from the summary sheets and rapid data machine processing. These data are unique because, for the first time, land use information in combination with soil and other information is available on a uniform basis for the whole country. The data can be assembled to make estimates for any area by selecting and summarizing the sample plots included.

In addition to making compilations of the data, however, the sample plots themselves provide a statistical sample already drawn for making many types of studies by means of air photo analysis. In a project recently completed, air photo analysis of the sample plots was used to determine the potential for recreation sites and hunting areas for the north-eastern United States. In the time available it was impossible to study the entire sample (about 18,000 plots), so a random sub-sample of 4,500 was drawn for air photo analysis. The plots were examined to identify five basic types of recreation sites and each sample plot was classified as to the game species it would support. Data on the number of potential sites, as determined by air photo analysis, were applied to the total acreage of forest, idle or pasture land in the sample universe to compute the rate at which the potential sites occurred. For example, we found that at least one in five basic types of site occurred for each 129 acres of forest.

Using air photo analysis with this sample enabled us, in the year, to make this estimate for ten states available for the study. Even with use of a sample, we found that handling and accounting for a large number of plots presented a problem. The original operation plan was to borrow copies of the sample plots on air photos from county field offices and to return them after the recreation study had been completed. We soon realized that copies of the sample plots would be useful for other studies, and that microfilming was the most economical way to copy and retain the material. The county sample location maps were copies on 35-mm microfilm, and for the sample field plots and summary sheets 16-mm microfilm was used. We now have a convenient file of 400 county maps and 18,000 sample plots for the north-eastern United States for use in future research studies.

CONCLUSION

Use of air photo analysis in land utilization research has provided acceptable data for economic analysis within

time limitations imposed and with minimum expense. The three methods developed present a choice of procedure in using air photo analysis depending on problem requirements. When appropriate they can be used singly or in combination as a substitute for field mapping, partic-

ularly where data are needed for large areas. Air photo analysis is not a substitute for detailed field study, but we are getting suitable data in relatively short time, at low cost and with a minimum number of experienced workers.

APPLICATION OF AERIAL PHOTOGRAPHY TO THE ECONOMIC ANALYSIS OF LAND USE FOR URBAN PLANNING

Background paper by Matthew M. Witenstein, Capitol Research Associates, Land Economists and Planners, Rockville, Maryland

ABSTRACT

This report presents an item-by-item tabulation, for the major components of urban analysis, of the uses and limitations of aerial photography. It describes the application of techniques for urban land study in the sequence of inventory, analysis and plan. Its development should provide a guide to city and country administrators and photogrammetric engineers alike in planning surveys based on aerial photography and should encourage the more extensive use of aerial survey methods in day-to-day administration.

This report considers techniques for analysing the dynamic economic forces of urban growth and change which underlie engineering considerations in urban land use. The dynamics of growth and directions for future development can thereby be systematically studied to provide reasonable predictions of future urban growth and future land use requirements. These techniques have been developed as part of a continuing investigation into methods for using aerial photography to supply data on land use for urban planning and real estate development.

The great advantage in using aerial photography lies in its ability to provide the analyst with a powerful tool which is at once an over-all perspective of the city, an historical record of its growth, a means for comparative analysis of various uses of the land, and a means for gathering statistical data not otherwise available for any area he wishes to consider.

Techniques for extracting useful statistical data about the urban area from aerial photography are based on delineating various sections of the city according to the functional use of the land, the structural arrangement of buildings and the built-up area density, and then determining the mathematical relationships among these features.

Over the past ten years the author has presented reports on a continuing investigation on systematic methodology for applying aerial photography to various problems in urban planning. These and similar techniques have now become widely accepted and find application in all phases of urban planning related to zoning, utility service areas, trade areas, civil defence, subdivision layout, industrial location, traffic flow and other administrative activities. Data of this type have been especially useful in real estate development.

To determine the applicability of various methods for urban analysis, a small town was selected as a test area in which various problems could be readily isolated and studied over a period of several years.

The area selected for testing was the city of Rockville, Maryland, a typical small town caught up in the rapid suburban expansion of a large metropolitan area. The town exhibited all the basic problems of administration and planning engendered by rapid growth, traffic congestion, inadequate facilities, small staff and, above all, lack of adequate data to meet the changing events. In the seven years during which this town has been studied, the population has grown from 13,000 to almost 30,000 at the beginning of 1961. In 1953, the town was thinking mainly in terms of its traditional role as a rural county seat. Since then, new elements, largely urbanites from Washington seeking a suburban way of life and interested in improving the local community, have become the moving force in its development.

The first report in this investigation¹ discussed the basic methodological concepts of photosociometrics, a measurement technique for the study of land use in aerial photography.

These techniques are predicated on the concept that urban patterns are the physical manifestations of complex cultural and economic events, as well as the results of specific adjustments to climate and terrain.

The study of land use therefore consists of organizing the physical features of each area of the city into distinct patterns which are readily determined in aerial photography. These are the patterns of function, structure type and density of roof cover.

The function pattern represents the major land use categories, such as industrial, commercial, governmental, institutional, recreational, port, railway or residential.

The structure type pattern consists of the categories of warehouses, storage yards, factories, commercial buildings, schools, churches and various residential—apartment, row and single—dwellings.

The density of roof coverage pattern indicates the arrangement, organization and limits of dense, moderate and sparsely built-up areas.

The characteristics of each area are easily determined from aerial photography because specific types of construction are required for each function. Types of construction in industrial, port or railway areas reflect the needs and capacity of the industrial production or of the transport media. Types of construction in residential areas reflect the ability of different classes of people to command various categories of housing and living space.

The three forms of distribution bear the following relationship to each other. *Function* is the major com-

¹ *Photogrammetric Engineering*, v. 20, No. 3, 1954, page 419.

COMMERCIAL-INDUSTRIAL LAND-USE

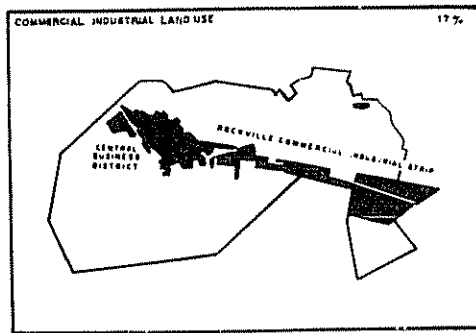

DATA OBTAINED

- * Location and classification of all commercial industrial, parking, non-conforming and vacant areas zoned commercial-industrial
- * Measurement of size of commercial and industrial floor areas, parking lot spaces, and vacant space.
- * Ratios of:
Zoned commercial/ Total urban area
Occupied and Vacant/ Zoned
Parking/ commercial

APPLICATION AND ACCURACY

- * Supplied basic statistics well within required accuracy for planning of zoning changes, acquisition of parking lots, street improvement.
- * Ground-check was required to locate non-conforming dwellings used for commercial. This class comprised less than 4% of area.

RESIDENTIAL LAND-USE

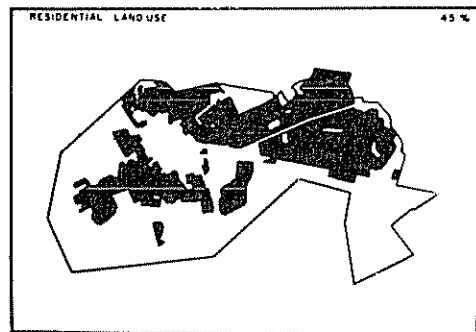

DATA OBTAINED

- * Location and classification of all residential areas by density, structure-type, and lot size.
- * Measurement of zoned areas occupied, number and type of dwellings, floor area per dwelling and percent of zoned area built up.
- * Computation of population by dwelling type and area.

APPLICATION AND ACCURACY

- * Accuracy of dwelling count, size and type of lot within 2% of ground checked sample area.
- * Basis for changes in zoning, acquisition of school and recreation sites, trade areas, utility requirements, tax assessment among many others.

STREETS AND TRANSPORTATION LAND-USE

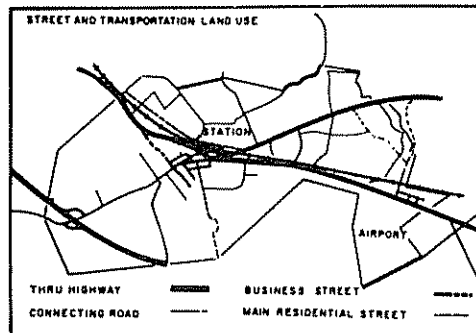

DATA OBTAINED

- * Location and classification of all streets by use as through highways, primary and secondary connecting roads, business and residential streets.
- * Location and classification of railroad, bus, and airport facilities.
- * Measurement of streets by total length, width and use type.
- * Traffic potential according to adjacent land-use, pattern of streets, and number of dwellings, served by each street.

APPLICATION AND ACCURACY

- * Data used for right of way acquisition street improvement, traffic flow analysis. Adequacy of railroad facilities equated to needs for proposed commuter railroad traffic.
- * Use classification based on photo study of surrounding land use and general familiarity with the area.
- * Street dimensions and mileage within 2% of city engineer's ground survey.

Figure 94. Aerial photography applied to urban land use inventory

Figure 94 (continued)

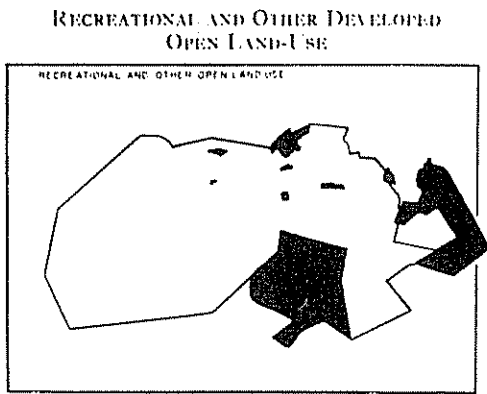

DATA OBTAINED

- * Location and classification of all parks, golf clubs, and cemeteries.
- * Measurement of area occupied, number type and capacity of buildings and other outdoor facilities.
- * Ratios of available facilities to requirements per thousand inhabitants.

APPLICATION AND ACCURACY

- * Basis for zoning changes, acquisition of new parks and facilities to meet needs of growing population.
- * Data well within range of accuracy required for planning.

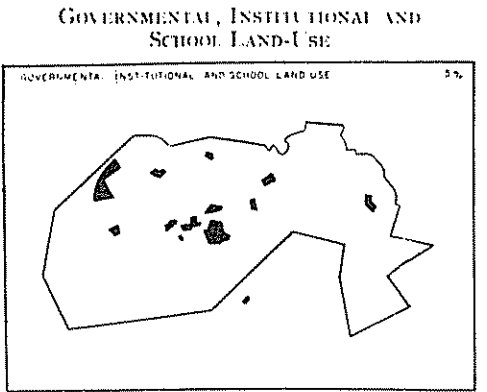

DATA OBTAINED

- * Location and classification by type and area.
- * Measurement of land occupied, number and type of structures and outdoor facilities.

APPLICATION AND ACCURACY

- * Basis for school district planning particularly for new subdivisions.
- * Ground check to determine denominations of churches, purpose of institutions and indoor facilities.

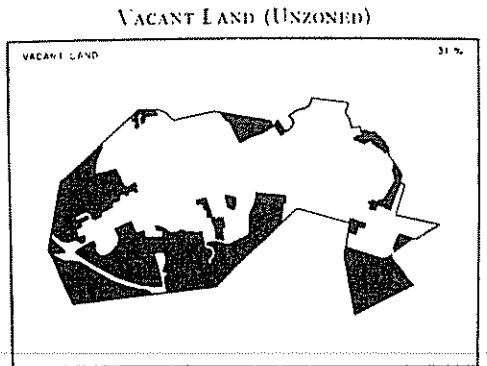

DATA OBTAINED

- * Location and classification of farm, fallow and wooded areas
- * Measurement of size: description of terrain in each area.

APPLICATION AND ACCURACY

- * Basis for planning new zoned areas
- * Measurements well within required accuracy for planning.

ponent, which is subdivided into its *structure types*; in turn these are modified by degree of *density* of roof cover.

Ground sampling of small areas within each area, supported by documentary information, supplies the basic data by which the spacial extent of area, measured in air photos, provides useful urban data.

These techniques were also tested on cities outside the United States, in areas where the pattern of urban development had an entirely different utilization of urban land.

A report published in the International Archives of Photogrammetry² describes the analysis of a city in India where two different cultures in juxtaposition for a long period of time could be studied. The specific prob-

lem selected was to determine water requirements from the patterns of land use in the city of Kanpur. The various residential, industrial and other functional areas of the city were identified and delineated in aerial photographs and their extent translated into amount of population or size of industrial plant. Such data could be used to estimate requirements for water facilities.

The second report on Rockville³ covered the development of photo techniques to aid detailed ground sampling of small areas. This sampling in turn provided the air photo study criteria for city-wide and county-wide evaluations based on aerial photography. The method was applied to the consideration of availability of vehicles for evacuation of home population in the event of a civil defence emergency and also to various patterns of movement under changing conditions of possible radioactive

² International Archives of Photogrammetry, *Proceedings of the Seventh International Congress of Photogrammetry, Washington, D.C., September 1952*, v. 11, part 3, 1954, page 710.

³ *Photogrammetric Engineering*, v. 21, No. 4, 1955, page 566.

fallout. These data were developed by traffic drainage sheds for which the air photo was used to relate dwellings and vehicles to means of egress.

The third report on Rockville⁴ detailed the general application of photosociometrics to the study of land use in a systematic sequence of (1) land inventory, (2) analysis and (3) plan, and is presented here briefly because the methodology is basic in urban planning.

Only slight additional cost is entailed in projecting the use of aerial photography from mapping to analysis and planning.

In each of the three main aspects of urban study indicated in figure 94 the application of aerial survey permits:

Inventory. A complete inventory of the physical features of the urban area; the topography of its site and surrounding area, the drainage pattern, built-up and open areas, the road pattern and other means of communication and the location and identification of individual installations;

Analysis. The classification of the features of the urban area as land use patterns of function, structure type and built-up area density, so as to characterize the population distribution, industry, commerce, community services and facilities, and the movement of people and goods;

Planning. The relating of engineering standards to land use features, in order to plan the size, capacity and location of facilities, and to estimate the amount of work entailed in preparation of site.

INVENTORY

Inventory is the first step in land use study. It permits a town to take stock of its resources and to gain an overall appreciation of its problems.

From the air photo, data are assembled by area, by delineation of the built-up area, road system, functional areas, structure types and vacant land. These are classified by number and type and assembled as patterns which characterize the distribution of population, commerce and industry, community facilities and means for movement of people and goods.

Three principal categories of information are considered in the inventory:

- (1) Location and classification of all features, as distribution patterns;
- (2) Measurement of size and capacity, to develop basic statistical data assemblies;
- (3) Computation of ratios of land use and land zoned, service availability and facility accessibility to residential, commercial and industrial needs.

Beyond meeting the need for over-all planning data, the air photo has surprising accuracy and capability for developing detailed statistical data. Figure 94 presents a series of panels which summarizes for each land use category the scope, applicability and accuracy of inventory data obtained from aerial photography with some ground check.

ANALYSIS

Analysis is made by combining the inventoried data (such as number of inhabitants per dwelling unit obtained

by ground sampling, number of cars per dwelling unit, daily water use per capita) with planning multiplier factors, such as road capacity per thousand vehicles, school rooms and acres of recreational land per thousand people, commercial floor area per thousand dollars of sales. Detailed ground sampling and constant checking of literature improve the accuracy of the multipliers. By this means, pertinent data can be assembled for almost any analytic purpose.

With these data a second reading of the air photos is made to locate the reasons for outstanding existing and potential planning problems. As an example of the application of the analytic phase of the study, one facet of the land use inventory and its succeeding analytic and planning considerations are illustrated.

The central business district was laid out originally to serve the older western portion of the city—which was the entire city prior to 1949 but which now includes only one-seventh of the total population. The business community had failed to appreciate how large and rapid the expansion would be in the eastern portion of the city, which now includes six-sevenths of the population. Adequate provision was not made for this trade; merchants were content with a modest increase in sales. However, even this modest increase resulted in a considerable traffic congestion because roads and parking facilities were inadequate for accommodating this new trade.

Figures 95A and 95B illustrate the problem and the method for solution of central business district traffic problems.

PLANNING

Study of the photos also suggested a programme for long-range development of a larger and more adequate business district (figure 95C).

The objective was to take advantage of Rockville's superb central position in the expansion of the surrounding county, where new science industry was developing on a large scale because of the proximity to the national capital. When the city expands through annexation to the maximum expansion limits proposed in the master plan, there will be 14.1 square miles (9,049 acres) within the city, 5.5 square miles (3,520 acres) of which will be served by the new sanitary sewer system (figure 95D).

The western portion of the city is at present (1961) also growing rapidly. This is bringing the business district back into a central position once again. A huge new shopping district is under development to take advantage of this new situation, thus generally following the originally suggested plan. One of the new facilities in this centre is a huge home furnishing mart, which is a unique facility designed to attract trade to Rockville from a wide surrounding area.

An urban renewal programme is also under way to rebuild the older commercial areas so that they can be combined with the newer commercial development into one huge new central business district.

The changing situation for the central business district of Rockville from a central to a peripheral position and back to a central position within a period of ten years points up the necessity for considering the effects of time as a dynamic economic force in the analysis of land use.

We have learned that land use planning, to have any long-term validity, must closely consider the complex economic forces which constantly change the utility of various areas of the city.

⁴ *Photogrammetric Engineering*, v 22, No. 4, 1956, page 656.

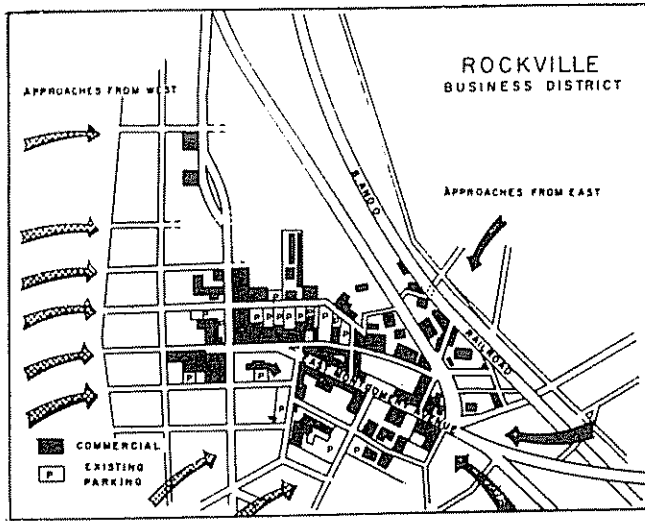

A

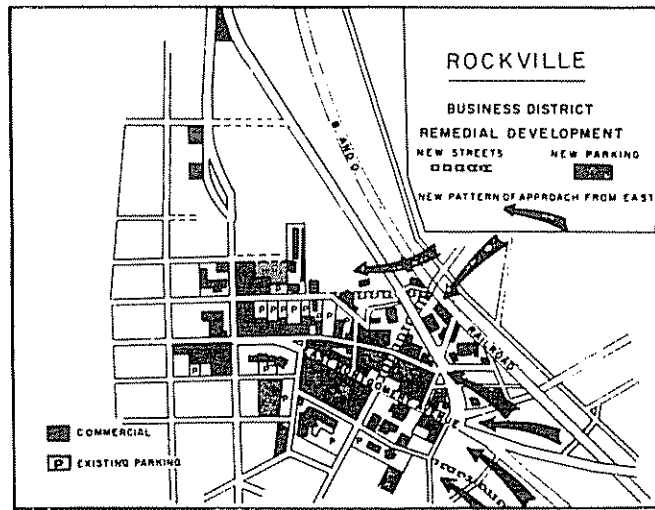

B

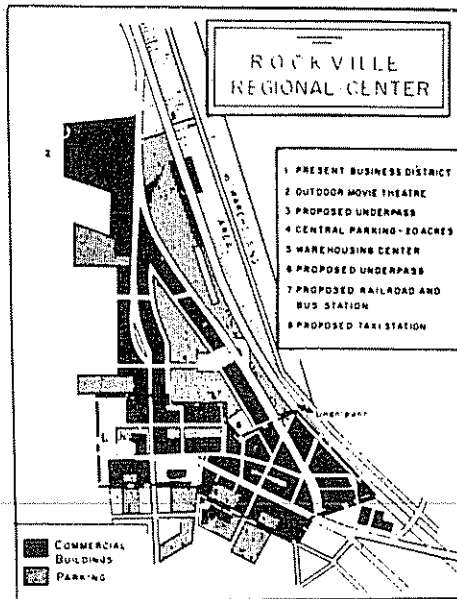

C

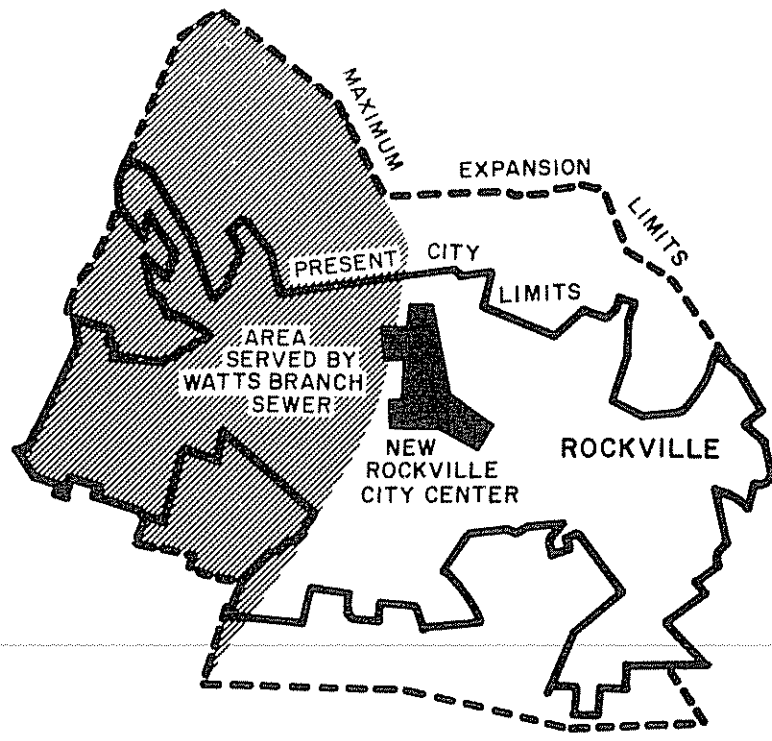

D

Figure 95. Aerial photography applied to urban land use analysis (A and B) and planning (C and D)

A—Traffic patterns in central business district. The eight routes of approach to the central business district serve one-seventh of all the families. Two routes of approach from the east serve six-sevenths of all the families as well as heavy through traffic. The majority of this traffic uses the narrow main business street, going and coming. The other route from the east serves only a small section of the town; B—Remedial traffic and parking development. Improvement in traffic circulation is possible by creating new routes of approach and proper placement of new parking lots. The air photos revealed that present parking capacity could be more than doubled by using wasted backyards, alleys and vacant lots in the business district and that new streets could be constructed without dislocating existing occupants. The new pattern of approach from the east would reduce movement on the main street yet provide equal or greater access to shops; C—Future growth. Suggested expansion of present business district on to vacant land lying to the north. The large central parking area, underpass approach, and additional parking provided by the commuter parking lot adjoining the railroad would provide an attractive centre with adequate parking and access routes; D—This drawing shows a huge area just opened up for development in the western part of the city through completion of the Watts Branch Sewer

APPLICATION OF AERIAL PHOTOGRAPHS AND REGRESSION TECHNIQUES FOR SURVEYING THE CASPIAN FORESTS OF IRAN¹

Background paper by Earl J. Rogers, Research Forester, Forest Survey Branch, United States Forest Service

ABSTRACT

A forest survey project for the Caspian forests was started in 1958. United States technicians were selected to help in the operations of this project which covered 3,420,000 hectares. Forest area, volumes and growth were determined using new applications of photo-interpretation and ground techniques. A new scheme for determining photo scale was used for the first time on a large project. The photo plot measurements, ground plot volumes and ground plot growth were compiled using a multiple regression. The sampling errors and the source of sampling error were shown and presented in a compact package. This report is limited to 98,000 hectares where the survey was completed. The methods used proved satisfactory and are recommended for other forest survey projects. The material presented was drawn from the Programme Instructions of the Caspian Forest Survey, which is a project of the Iranian Forest Service, Tehran, Iran.

INTRODUCTION

Iran with its 20 million people is starving for forest products while just a few miles from Tehran, the capital city, are virgin hardwood forests. These forests are located on the northern slopes of the rugged Elburz Mountains facing the Caspian Sea. The major objective is to place these forests under intensive management and increase the supply of forest products on a sustained yield basis as soon as possible. A secondary objective is to produce maps at 1:50,000 scale for this forest area.

The Plan Organization of Iran (the agency responsible for financing the economic development of Iran using oil revenues) recognized this forestry problem and allotted funds to the Iranian Forest Service to conduct the Caspian Forest Survey. The Iranian Forest Service enlisted five United States forest technicians to develop, train, organize and furnish advice to this programme which encompassed 3,420,000 hectares comprising the Caspian Forest region. The programme was started in 1958; completion of the over-all programme is expected in about two years. The results of applying aerial photographs and regression techniques together are given in this report for a portion of the area recently completed.

The design applied to this forest survey was published in *Photogrammetric Engineering* in June 1960. This report, however, is limited to 98,000 hectares of land, known as the Tavalesh Forest, located about eighteen miles west of Rasht, Iran (see figure 96). All the details for conducting such a programme cannot be covered, but those relating to new developments will be emphasized—especially those pertaining to the use of aerial photographs.

In applying this design to the Tavalesh Forest, three intensities of sampling were used. These included

2,831 photo points, 2,308 photo plots and fifty-four ground plots. Briefly, the photo points are classified for forest and non-forest land, the photo plots are the locations for making stand measurements on aerial photos and the ground plots are locations for collecting the ground forest data. The photo points were the basis for estimating forest area. The photo plots and ground plots were the basis for the construction of a regression of photo measurements to ground values. This regression is an important key to measure gains made through photo-interpretation.

This programme was administered by the Iranian Forest Service in Tehran, Iran, and the author is grateful to the Iranian Forest Service for the use of their data.

AERIAL PHOTOGRAPHS AND MAPS

Aerial photographs of four types and maps at scale of 1:250,000 were available for this programme. These are discussed separately.

Vertical aerial photographs at 1:50,000 scale completely cover the project area. The photos were delineated to show four forest types, beech, oak, mixed hardwoods and cypress; three density classes, poor, medium and well stocked, and four stand height classes corresponding to seedling and sapling trees, pole trees, young sawtimber trees and old sawtimber trees. These aerial photographs were also used for field delineation of map features and for field completion of geographic names, road classifications, trails, etc. These photographs also served as map substitutes in the absence of detailed maps. The present 1:250,000 maps were not satisfactory for field planning and guidance. But the 1:50,000-scale photos were very useful for this purpose and were part of the field parties' equipment.

The coverage by 1:25,000 oblique panchromatic aerial photography was incomplete. This was only used to assist in the delineation, planning and field operations. In addition, it served to supplement the coverage of 1:50,000-scale photos.

The 1:10,000-scale vertical panchromatic aerial photography completely covered the Tavalesh Forest. On the Tavalesh area these photos were used in place of the 1:50,000-scale photos for the forest delineations. Also, these photos were used for classifying and measuring the photo plots, which consisted of an area of 0.1 hectare. The three tallest trees were measured here and the crown density was estimated for the dominant and co-dominant trees.

Tree heights were determined with the help of a parallax wedge. The principles used in applying the wedge were not new but the method of determining scale of the photo at the plot was unique. A further comment on this is desirable. Since the 1:250,000-scale maps were of little value for determining photo plot scales it was necessary to develop another technique. The technique developed applies radial line triangulation, the basis for map com-

¹ The original text of this paper and those of the following two papers were submitted by the United States of America and appeared together as document E/CONF 36/L.60.

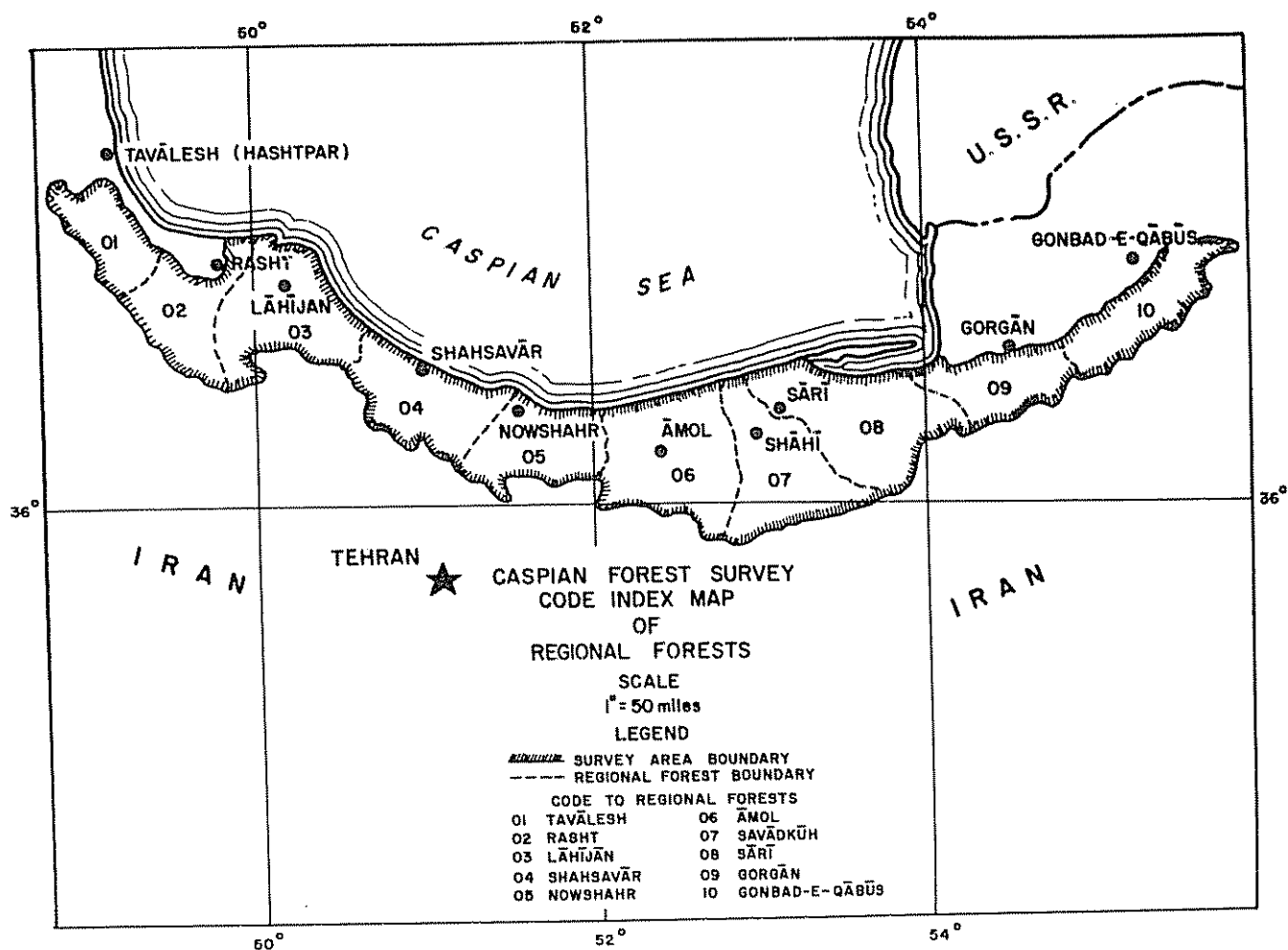

Figure 96. Caspian Forest Survey Code Index Map of Regional Forests

pilation. All that was wanted from this triangulation network was the location of photo centres to a known scale. This gave the ground distance (B) between photo centres. By dividing this ground distance by the parallax at the photo plot, the photo scale for the plot was determined. This is the formula:

$$PSR = \frac{B}{P} \text{ where:}$$

PSR = reciprocal of photo scale in representative fraction;

B = ground distance in metres between photo centres;

P = parallax in metres at photo plot.

Having solved for photo scale, the measurement of tree heights, crown diameters, slopes and distances became routine. Crown density was estimated using a crown density guide. The photo plots were marked with ink and located so as to get a complete systematic sample of the area. The mark consisted of four straight lines, all heading towards the plot centre but stopping short so that the plot area (0.1 hectare) was not marked. Photos were viewed stereoscopically, using a pocket stereoscope, and data were placed on a photo-interpretation record form.

Strip scale of 1:5,000 panchromatic aerial photographs were taken at about ten mile intervals across the project area. These were used for photo plot measurements and for the selection of ground plots in those areas outside the Tavalesh Forest.

The only maps available for the entire project were 1:250,000 scale; these were useful for planning purposes but of very little value to the field crews as the scale was too small. The aerial photographs were more useful for this purpose, as pointed out above. For forest management purposes these maps were also of very little value.

PROCEDURES FOR FOREST AREA ESTIMATE

The 1:250,000 maps were used to determine the project area. The project boundaries were marked on these maps. Then a dot grid was laid over the maps and a dot count was made of those dots in or out of the project. A ratio of project dots inside the project to total dots was next obtained. The area of the map was determined from the US Geological Survey standard quadrangle area tables. The area in the project equalled the portion of the dots in the project area times the map area. This information was obtained for each map sheet covering the project, as shown in table 1.

Table 1. Caspian Forest survey area: summary of gross area, by map quad

Map quad number (1)	Total area of quad (hectares) (2)	Total dots in quad (3)	Dots in project area (4)	Ratio project dots to total dots (4 ÷ 3) (5)	Caspian Forest survey area (2 × 5) (hectares) (6)
NJ39-9	1,472,166	5,854	1,373	0.2345	345,223
39-10	1,472,166	5,854	1,223	0.2089	307,535
39-13	1,491,218	5,950	224	0.0376	56,070
39-14	1,491,218	5,950	1,498	0.2518	375,489
39-15	1,491,218	5,950	2,754	0.4629	690,285
39-16	1,491,218	5,950	4,197	0.7054	1,051,905
NI40-9	1,720,194	6,830	305	0.0447	76,893
40-10	1,472,166	5,854	388	0.0663	97,605
40-13	1,491,218	5,950	1,574	0.2645	394,427
40-14	1,491,218	5,950	21	0.0035	5,219
1-39-E	1,006,847	3,933	78	0.0198	19,936
TOTAL					3,420,487

By this procedure it was determined that 3,420,000 hectares of gross land area were in the Caspian Forest Survey project and 98,000 hectares of gross land area were in the Tavalesh area.

The forest area within the project area was estimated using aerial photographs. The 1:50,000 aerial photographs were used for this purpose for all the project except the Tavalesh area, where the 1:10,000-scale aerial photographs were used. The boundary line of the project was marked on the aerial photographs. Then, on every alternate print a dot grid (sixteen dots per inch) was laid over the photo. The dots actually observed and recorded are only those within the net area of the photo, so as to prevent duplication or gaps in covering the project area. Each dot was studied to determine whether it fell on a forest or a non-forest area. A careful record was made by each photo of the number of dots falling on forest or on non-forest in the project area. For this purpose, 338,580 points were classified. Only 2,831 of these points were classified on the Tavalesh area and 2,308 of these were forest. The portion of forest area was obtained by dividing 2,308 by 2,831, which is 0.8151. The area in forest was 0.8151 times 98,000 hectares, or 79,880 hectares. Other information was noted for each dot falling in Tavalesh Forest, such as forest region, watershed, political division, ownership and commercial forest. This information was used for breakdown area estimates of the forest land (see table 2).

Table 2. Tavalesh Forest: commercial forest land area, by major forest type

Forest type	Hectares	Percentage of total
Beech	21,489	26.9
Oak	19,891	24.9
Mixed	38,423	48.1
Cypress	80	0.1
TOTAL, all types	79,883	100.0

PROCEDURES FOR VOLUME ESTIMATES

The following formula is the basis for computing the average volume per hectare:

- $\bar{V}_i = P_i(a + b_1\bar{X}_1 + b_2\bar{X}_2)$ where:
- \bar{V}_i = mean volume per hectare of gross land area;
- P_i = portion of forest land to gross land area interpreted from photo points;
- a = constant, computed by method of least squares;
- b_1 = regression coefficient for heights computed by method of least squares;
- b_2 = regression coefficient for crown density computed by method of least squares;
- \bar{X}_1 = average total height of three tallest trees measured on all forest photo plots;
- \bar{X}_2 = average crown density measured on all forest photo plots.

The regression constant and coefficients were computed from the data collected from fifty-four ground plots and the corresponding photo plots using a method of least squares. For each ground plot the field data was reduced to a net volume per hectare by usual procedures used in forest survey compilation. The ground plots were mechanically selected as every forty-third photo plot. The data produced the following regression formula:

$$\bar{V}_i = 0.8151 (21.8297 + 3.6506\bar{X}_1 + 1.3565\bar{X}_2)$$

The 2,308 photo plots furnished the average stand height ($\bar{X}_1 = 18.7$) and the average density ($\bar{X}_2 = 63.0$). Applying these average values to the formula, the average volume per hectare of gross land area (\bar{V}_i) equals 143.0952 cubic metres. The product of the average volume per hectare times the gross area (98,000 hectares) gave a total cubic metre volume of 14,023,300.

This total volume was distributed by types or other classes using volume portions obtained from ground plots as shown in table 3.

Table 3. Tavalesh Forest: net volume of growing stock on commercial forest land, by stand volume class

Stand volume class (cubic metres per hectare)	Cubic metres	Percentage of total volume
0—49	252,000	1.8
50—99	1,447,000	10.3
100—149	729,000	5.2
150—199	1,528,000	10.9
200—299	5,778,000	41.2
300—399	1,541,000	11.0
400—499	1,900,000	13.5
500—749	848,000	6.1
750 or more	—	—
TOTAL	14,023,000	100.0

The variance of the mean volume per hectare of gross land area included the contribution independent of the regression, contributions from photo measurements of height and crown density, contribution from forest area and the contribution from regression coefficients (see table 4). The variance of the mean volume per hectare of gross land area was 173.3. The standard error was 13.17, or 9.2 per cent of the mean volume.

PROCEDURES FOR GROWTH ESTIMATES

The estimate of total net growth followed the same procedures used for volume. A regression was used similar to volume except that growth per hectare replaced volume per hectare and only crown density was used for photo measurements, since tests showed that height was not significant for growth. Data for the regression were based on the same plots as were used for volume. Growth

Table 4. Distribution of volume variance based on cubic metres

Source	Population variance	Number of samples	Variance of mean
Independent of regression	9,122	54	168.9
Photo measurements	1,635	2,380	0.7
Forest area	4,647	2,831	1.6
Regression coefficients	2.1	—	2.1
TOTAL	15,406		173.3

Standard error = $\sqrt{173.3} = 13.17$

Percentage standard error = $\frac{\text{standard error}}{\text{mean}} = \frac{13.17}{143.09} (100) = 9.2$

was determined from measurements of annual rings, which were reduced to growth per hectare (\bar{G}_t) by the usual forest survey procedures. The growth regression formula was as follows:

$$G_t = 0.8151 (0.8997 + 0.331 \bar{X}_2)$$

By applying the average crown density ($\bar{X}_2 = 63.0$) to this formula, average net cubic metre growth per hectare proved to be 2.4331. The product of growth per hectare times gross area was the total cubic metre net growth, which equals 238,443.

Like volume, the distribution of growth is made in proportion to the ground plot growth, as illustrated in table 5. The volume for trees having died during the past year was mortality volume. This volume was deducted from the computed net annual growth.

Table 5. Tavalesh Forest: net annual growth, mortality and commodity drain of live sawtimber and growing stock on commercial forest land

Item	Sawtimber		Growing stock	
	Cubic metres	Percentage	Cubic metres	Percentage
Total net annual growth	202,936	100.0	238,442	100.0
Sound trees	180,012	88.7	207,247	86.9
Sound cull trees	12,935	6.4	20,382	8.6
Rotten cull trees	9,989	4.9	10,813	4.5
Annual mortality	26,119		26,119	
Adjusted net annual growth	176,817		212,323	

The variance of the mean growth per hectare of gross land area included the same sources as those for volume.

This variance was 0.0588. The standard error was 0.2421 or 9.9 per cent of the mean value.

Table 6. Distribution of growth variance based on cubic metres

Source	Population variance	Number of samples	Variance of mean
Independent of regression	3.1360	54	0.0581
Photo measurement	0.3946	2,380	0.0002
Forest area	1.3429	2,831	0.0005
Regression coefficients	0.0000	—	—
TOTAL	4.8735		0.0588

Standard error = $\sqrt{0.0588} = 0.24$

Percentage standard error = $\frac{0.24}{2.43} (100) = 9.9$

The only maps available (1:250,000 scale) are not satisfactory for forest management purposes. As a minimum, maps at 1:50,000 scale are needed. In order to fulfil this need a programme was designed to furnish these maps. The Iranian Forest Service assumed responsibility for the delineation and field completion part of the programme while the compilation and printing were to be contracted to private firms or other government agencies.

The delineation consisted of two parts, forest delineation and map features delineation. The forest delineations included land use, forest type, stand density and stand height classes. The 1:10,000-scale photos were used for this work on the Tavalesh area and 1:50,000 photos were used for the remaining area. The map features delineation followed the general procedures established by the US Army Map Service and adapted by the Geographic Department of the Iranian Imperial Army. This part of the programme has not been completed for the Tavalesh area, so it cannot be reported on at this time.

Gains made by the use of aerial photographs and regression techniques are expressed in the number of ground plots required when these techniques are not used. If these techniques were not used, ninety-two ground plots would be needed to furnish the same sampling error of volume estimate and eighty-seven ground plots for the same sampling error of growth estimate in the Tavalesh area. Cost comparisons should be made if reliable cost data are available. But at this time cost data are not available so this evaluation cannot be shown. Regardless of cost, the same accuracy of forest area would be practically impossible without aerial photographs. Also, without aerial photographs the costs of the mapping programme would be increased. The techniques used in this project performed according to expectancy. As the photo-interpretation improves, the population variance independent of the regression can be expected to decrease, thus further improving the efficiency of the programme.

SOME RECENT DEVELOPMENTS OF BASIC SIGNIFICANCE FOR PHOTO-INTERPRETATION

Background paper by Robert N. Colwell, Professor of Forestry, University of California

Several of the papers presented at this Conference have recounted significant progress being made in photo-interpretation as applied to a specific field, such as forestry, geology, agriculture or urban planning. The purpose of this paper is to summarize recent developments which, because of their very basic nature, are applicable to *all* of these fields of photo-interpretation and to many others as well. Although some of the material presented here may overlap that presented in other papers, it is believed that the fresh approach may justify the small amount of duplication.

The "fresh approach" attempted in this paper is mainly an organizational one. It has been arrived at through consideration of the following facts, which are as basic to photo-interpretation as they are obvious: if aerial photographic interpretation in any of its applied forms is to be employed successfully, four conditions must be satisfied: (1) the aerial photography must provide images of a quality suitable for extracting the type of information that is to be obtained through photo-interpretation; (2) the men performing this photo-interpretation work must have been properly selected and trained; (3) the equipment used in viewing, measuring and interpreting the photographic images must be of suitable quality, and (4) the methods and techniques used by the photo-interpreter must permit him to extract the desired information both efficiently and accurately.

The remainder of the paper attempts to recount recent developments within each of the four categories suggested by the above statement.

RECENT IMPROVEMENTS IN PHOTOGRAPHIC IMAGE QUALITY

This type of progress is best reported in terms of the major factors contributing to photographic image quality. According to one viewpoint (Colwell, 1954)¹, there are

three such factors: (1) the photographic tone or colour contrast between an object and its background; (2) the sharpness characteristics of the photographic image, and (3) the stereoscopic parallax characteristics. Without our having a clear understanding of these terms, it would be fruitless to describe recent progress relative to them. Figure 97 serves to illustrate the meaning of each of these three terms as applied to the images of a tree, as seen on a stereoscopic pair of aerial photos. A tree has been selected for this illustration, not only because it is the basic unit of interest to those making forest inventories from aerial photos (as reported in some of the other papers), but also because it is illustrative of many other three-dimensional objects in which photo-interpreters are interested.

By photographic *tone contrast* is meant the difference in brightness between an image and its background. Thus, in the black-and-white photography of figure 97, tone contrast is exemplified by the difference in brightness between points A and B of the photograph. Similarly, in colour photography, the term "colour contrast" pertains to the resultant of all the hue, value and chroma differences between an image and its background. If there were appreciably less tone contrast on the photos at the top of figure 97, the tree images would blend with the background and would be imperceptible.

By *sharpness* is meant the abruptness with which the tone or colour contrast appears to take place on the photograph. Thus, in figure 97, sharpness is indicated by the distance on the photograph over which the change from tone A to tone B appears to take place. If there were appreciably less sharpness on the photos at the top of the figure, the tree images would be merely unidentifiable blobs.

Often, in times past, photo-interpreters have considered that the only means by which they could see finer details on photographs was by obtaining photographs of larger scale. The relation of sharpness to photographic scale

¹ The references in parentheses are to the names of authors and the dates of publication of the books and articles listed at the end of this paper.

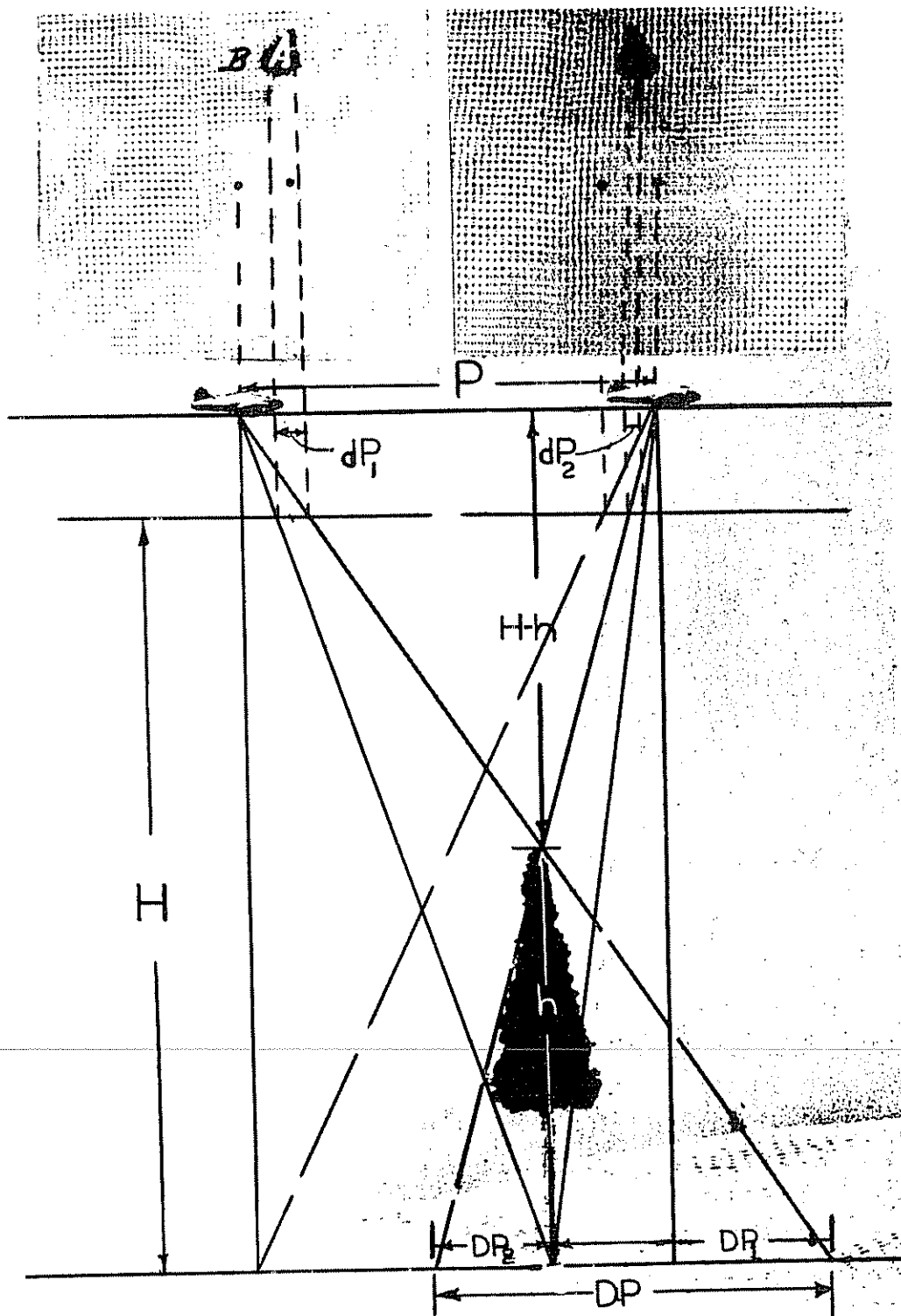

Figure 97. Three-dimensional model of a tree illustrating terms relating to photographic image quality

is apparent when we consider the resolution, or resolving power, of photography in terms of discernible lines per millimetre. The sharper the photography, the more lines per millimetre are discernible and the finer is the discernible detail. Thus, if a certain number of lines per object are required in order to be sure that a certain blob is a tree, this number of lines can be obtained by either (a) increasing the photographic sharpness (in lines per milli-

metre) at a given scale, or (b) increasing the photographic scale at a given sharpness. Since the cost of aerial photography, as well as much of the work done with it, increases roughly as the *square* of the scale, it often is more fruitful to consider means of increasing photographic sharpness, rather than photographic scale, when the objective is to see more detail on the photographs. Progress in this aspect of image quality will be cited presently.

Stereoscopic parallax is the displacement of the apparent position of a body with respect to a reference point or system caused by a shift in the point of observation. Thus, in figure 97, if camera stations 1 and 2 (indicated by the two positions of the aircraft) are the two points of observation, the stereoscopic parallax of the top of the tree with respect to its base is the ground distance, DP . The photo equivalent of DP is dP (the arithmetical sum of dP_1 and dP_2), which is the shift in the apparent position of the top of the tree with respect to its base as seen on the stereoscopic pair of photographs. If this shift is too *slight* it will not be clearly perceptible when two overlapping photos are viewed stereoscopically; consequently, tree height, a factor of great importance to the forest inventory expert, will not be clearly perceived on such photography. Likewise, if this shift is too *great*, it again will not be clearly perceptible when two overlapping photos are viewed stereoscopically. This is because human eyes are unable to fuse simultaneously two sets of images (one set for the top of the tree, the other for the base of the tree), when the sets require vastly different amounts of convergence of the observer's two lines of sight. Consequently, the requirement is to obtain *optimum*, rather than *maximum*, stereoscopic parallax in aerial photography.

Improvement in the tone or colour contrast characteristics

Recent improvements in this aspect of photo image quality become apparent when we consider that there are four main factors contributing to the tone or colour contrast characteristics of images as seen on aerial photographs. These are: (1) the spectral reflectivity of light from an object and from its background; (2) spectral sensitivity of the photographic film; (3) spectral transmission of the photographic filter, and (4) spectral scattering by atmospheric haze particles. In terms of these factors, the following progress has recently been made.

A greatly improved instrument for measuring the spectral reflectivity of light from an object and from its background has been developed. This is the portable spectrophotometer which permits spectral measurements to be made of sizable "in-place" samples (Dwornik and Orr, 1961). Previously, each sample had to be collected, mounted between two glass plates and placed in front of the small circular window of a laboratory-type spectrophotometer. The smallness of the sample analysed and the disrupted nature of the sample itself often resulted in erroneous values being obtained for the spectral reflectivity of objects. Consequently, serious errors resulted when attempting to select the best combination of photographic film and filter for use in making desired distinctions by virtue of photographic tone or colour contrasts.

Even when accurate spectrophotometric data are available, there is need for rigorous mathematical analyses of the data to determine which part of the spectrum will provide optimum tone or colour contrasts between an object and its background. According to Langley (1961), the computations required to determine, statistically, where this optimum contrast will be found are so involved as to necessitate the use of an electronic computing machine. He appears to be the first to have devised a satisfactory method of programming the raw data so that correct answers will be provided by the computing machine.

A very versatile colour film has been made available for aerial use, at a cost only moderately greater than that of conventional black-and-white film. Known as "Aerial Ektacolor", this film produces a colour negative of excel-

lent quality from which positive colour prints or transparencies as well as positive black-and-white prints or transparencies can be made. The black-and-white prints, when made on a special Eastman Kodak paper known as "Pan Allure", are of fully as good quality as those printable from conventional aerial panchromatic films. Of perhaps greater significance, photo-interpreters have already found that opaque colour prints made from these same negatives on a colour-sensitized paper known as "Printon" greatly facilitate the photo mapping of soil boundaries (Dominguez, 1960), the photo identification and height measurement of trees (Veruette, 1961), and the photo-interpretation of rock types and determination of their orientations and distributions (Fischer, 1958). The colour prints are essentially as adaptable to field use as are black-and-white prints and are prepared, at only moderately greater cost, from the colour negatives. The colour transparencies are even more interpretable than the colour prints, but ordinarily they must be viewed in the laboratory over a light table.

Another colour film, known as "Camouflage Detection Film", although developed nearly twenty years ago, has recently been found to be very valuable as a means of differentiating at an early date between healthy and unhealthy vegetation (American Society of Photogrammetry, 1960). Such distinctions are made only with great difficulty, if at all, on conventional black-and-white or colour photography at this early date.

Technological improvements in the construction of narrow-band-pass filters have made it feasible, for the first time, to exploit tone or colour contrasts between an object and its background. Without this development, many of the findings available through use of improved spectrophotometers and electronic computers, as previously discussed, would remain unexploitable by the photo-interpreter (Langley, 1961).

Greater appreciation of the selective scattering of spectral energy by atmospheric haze particles has resulted in better photo image quality being obtained, particularly on low-altitude, large-scale photography where the objective is to discern the maximum of detail in shaded areas. In one recent experiment of this type (Colwell and Marcus, 1961) the objective was to develop a means of estimating the intensity of recreational use in wildland areas by means of aerial photography. Consistent with Rayleigh's Law, which states that the scattering of light is inversely proportional to the fourth power of the wave-length of the light, these investigators found that far more detail was discernible in shaded areas when the photographs were taken with short wave-lengths of light (380 to 450 microns). This is because only the scattered light illuminates shaded areas, including those in which recreationists most frequently will be found as they occupy the campgrounds of wildland areas. Consequently, the short wave-lengths, being scattered most, are capable of providing the best detail in shaded areas on large-scale, low-altitude photography. This finding is also of significance to the timber inventory expert who wishes to determine the kind and amount of vegetation in the forest understory, or who wishes to measure the heights of trees in dense stands where the forest floor is in heavy shade.

Improvement in sharpness characteristics

The main factors governing the sharpness of photographic images are: (1) aberrations of the lens system; (2) focus of the lens system; (3) image motions at the

instant of exposure, and (4) characteristics of the photographic materials.

Recent development of the Infragon lens has eliminated most of the lens aberration problems that until recently were experienced when aerial photographers attempted to obtain acceptably sharp infra-red photography through the use of conventional aerial camera lenses. Since conventional lenses have been colour-corrected at the time of manufacture on the assumption that only panchromatic minus blue photography would be taken with them, it is not surprising that they give poor image sharpness characteristics when used to take infra-red photography.

Improper focus of the lens system has, until recently, been an additional factor limiting the sharpness of infra-red aerial photographic images. This results from the fact that until recently infra-red photography usually was taken merely by placing infra-red-sensitive film in a conventional aerial camera. On such a camera the distance from camera lens to focal plane usually has been accurately fixed, on the assumption that only panchromatic minus blue photography will be taken with it. Since the wave-lengths used in taking infra-red aerial photography are brought to focus at a distance which is about 2 per cent greater than his normal focal setting, modern cameras used in taking infra-red photography have this improved focus feature as well as the improved lens characteristics previously mentioned. The infra-red aerial photography obtained with the improved equipment is considerably sharper than that obtained heretofore.

Image motions at the instant of exposure no longer need be of such magnitude as to detract seriously from the sharpness of aerial photographic images, because of progress in the development of two devices. One of these minimizes the amount of vibration of the camera at the instant of photography; the other, known as an "image-motion-compensation" device, compensates for the travel of images at the focal plane during the instant of photography. It is becoming increasingly common to require that aerial photography, when flown even from altitudes of 15,000 feet or more, be taken only with cameras equipped with an image-motion-compensation device. The purpose of this requirement is to ensure that the sharpest possible photographic imagery will be obtained.

Among the various characteristics of photographic materials which appreciably affect the sharpness of photographic images, perhaps the most significant is that of film graininess. The dilemma that has previously confronted photo-interpreters wishing to draft specifications for aerial photography was as follows: (1) if a fast film were used, it proved to be too grainy, with consequent loss of image sharpness; (2) conversely, if a very fine-grained film were used, it proved to be too slow, and sharpness was again lost, in this instance due to the aforementioned vibrations and other motions taking place during the prolonged instant of exposure. Recently, however, film manufacturers have made great strides in developing black-and-white aerial photographic films (including Eastman Kodak's "SO 213" and "SO 243" films) which are both acceptably fast (particularly in view of recent improvements in minimizing image motion) and unusually fine-grained (Tarkington, 1959). Similar progress also has been made with aerial colour film.

Improvement in stereoscopic parallax characteristics

From an examination of figure 97, it is apparent that the magnitude of stereoscopic parallax (dP) in a pair of

overlapping aerial photographs is directly proportional to the length of the air base, P , directly proportional to the height of the object, h , and inversely proportional to the altitude of photography, H .

In times past, those interested in making maximum use of aerial photographs in forest inventory, for example, have made several unsuccessful attempts to use very large-scale stereoscopic pairs of photos for the measurement of individual tree volumes on selected sample plots. Lack of success usually was attributable to the fact that the air base, P , was too large in relation to the tree height, h , and also somewhat too variable. Both difficulties have recently been overcome by simultaneous use of two cameras operating from opposite ends of a short boom mounted on a helicopter (Avery, 1958; Lyons, 1960a, b). This ingenious device should also permit the geologist, agriculturist and many others to study small selected spots of interest on large-scale aerial photography having a suitably small amount of stereoscopic parallax to permit detailed interpretation.

There has also been a need in times past for obtaining a greater amount of stereoscopic parallax on photography flown at a scale of 1:20,000 or smaller. Only by increasing the parallax could photo measurements of tree and stand heights, for example, be made to a usable order of accuracy on photography of such small scale. Recent experimentation with "convergent photography" indicates that the greatly increased stereo base offered by such photography usually provides a sufficient increase in the stereoscopic parallax to offer a workable solution to this difficulty.

RECENT IMPROVEMENTS IN THE SELECTION AND TRAINING OF PHOTO-INTERPRETERS

Until recently there was a tendency to assume that one person was as well suited to photo-interpretation work as another. Consequently, the selection process revolved primarily around considerations as to the relative availability of two or more people to handle an additional task, in this instance aerial photographic interpretation. However, we are gradually coming to realize that the differences between a good photo-interpreter and a poor one can be largely explained on the basis of (1) differences in visual acuity, (2) differences in mental acuity and (3) differences in general attitude toward the photo-interpretation task. Therefore, progress in this aspect is logically discussed under headings suggested by the above three factors.

Improved testing of the candidate's visual acuity

The stereoscopic test developed by Moessner (1954) has proved to be immensely popular among photo-interpreters, despite certain admitted inadequacies of the test. As indicated by our earlier discussion, however, stereoscopic parallax is only one of three primary photo image characteristics on which most kinds of photo-interpretation are based.

Figure 98 shows a somewhat more complete visual test chart (Colwell, 1959). It is a stereoscopic pair of actual vertical photographs of a three-dimensional resolution target. It is so designed as to permit the testing of a candidate's ability to perceive tone contrast and sharpness as well as stereoscopic parallax. Furthermore, these parameters can be tested in any desired combination, a factor of some importance since they typically are found in all possible combinations on actual aerial photographs.

The US Naval Photographic Interpretation Center is currently preparing a three-dimensional test chart of a similar nature. It is possible that such visual acuity test charts will be used quite extensively in the future in the selection and training of candidates for photo-interpretation work. The US Navy is also supporting a study of factors affecting vision in photographic interpretation

and their two-dimensional counterparts have been placed in orderly array against dark, medium and light-toned backgrounds. In left foreground is a standard Air Force resolution target; in right foreground is a sinusoidal type of resolution target consisting of long, dark-toned bars on a light background; behind these two panels are a grey scale and a second bar-type resolution target in which

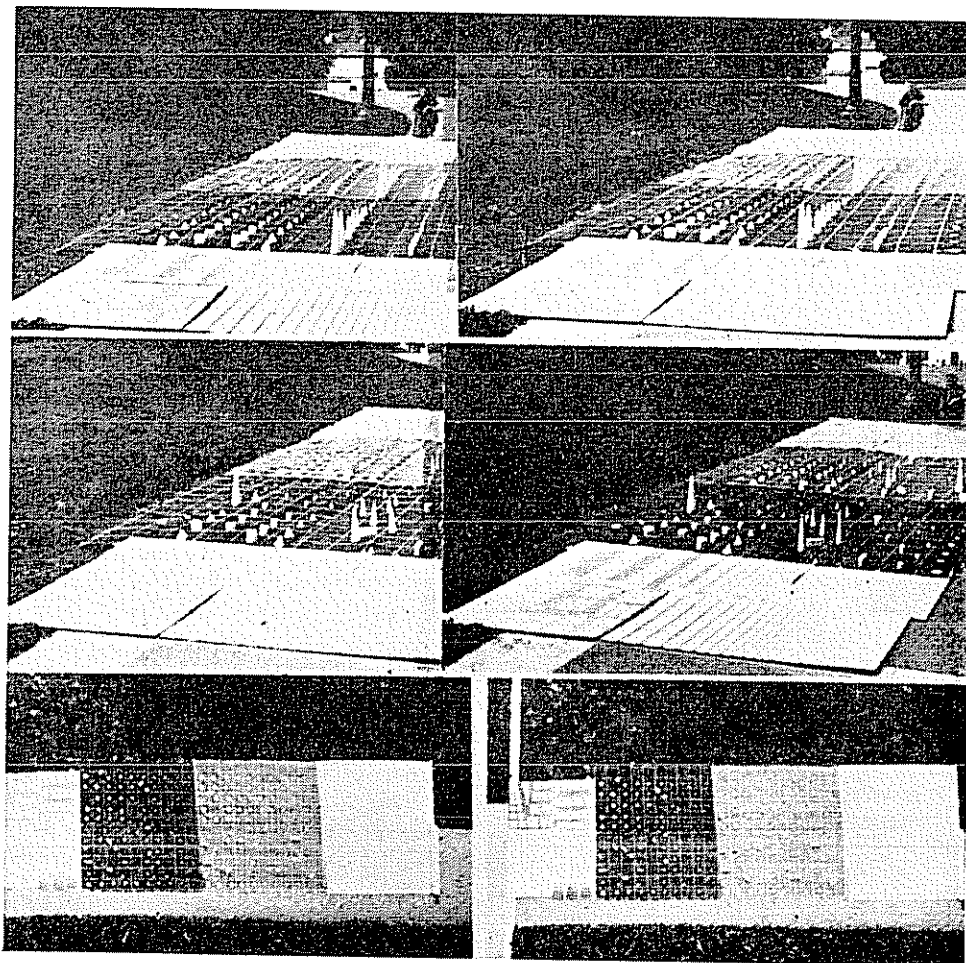

Figure 98 Visual test chart used in the testing of photo-interpreters

by Dr. Lund and associates at Tufts University. In addition, Rabben (1955, 1960) has written two excellent articles on the visual factors in photo-interpretation. These articles have done much to increase our awareness of the importance of visual acuity tests in determining the suitability of candidates for performing photo-interpretation tasks.

A composite resolution target suitable for (1) measuring the tone contrast, sharpness and stereoscopic parallax characteristics of aerial photography, (2) testing the detectability and recognizability of objects as a function of these three parameters, (3) testing the visual acuity of photo-interpreters under varying degrees of fatigue in terms of these same three parameters and (4) testing the clarity with which these three parameters can be perceived with various types of viewing equipment used by the photo-interpreter. *Top photo* is a stereo ground view of the target in which various three-dimensional objects

transition from dark tone to light is abrupt rather than sinusoidal. *Middle photo* is of same target, but the objects have been arranged in one of several random positions better to test the thresholds of detectability and recognizability. *Bottom photo* is a vertical stereogram of the same target with objects randomly arranged. It is on such vertical stereograms as this that the testing is done.

Improved testing of the candidate's mental acuity

Dr. E. Lawrence Chalmers, Jr. and his associates at the US Air Force Personnel and Training Research Center recently devised a series of tests for use in the selection of photo-interpretation trainees. Performance in most of these tests has been found to be closely related to performance in photo-interpretation. The tests which Chalmers used are summarized in table 1.

Table 1. *A Proposed Aptitude Test for Photograph Users*

1. *Spatial orientation* (subject must find the part of an aerial photograph that is identical with a small cutout);
2. *Aerial landmarks* (objects imaged in vertical photography must be detected in oblique photography);
3. *Plotting flexibility* (subject moves in certain directions according to codes);
4. *Estimation of length* (subject matches the length of a line to one of a series of variable standards);
5. *Object completion* (subject identifies objects from incomplete visual representation);
6. *Closure* (subject locates hidden faces and geometric figures and recognizes incomplete words);
7. *Picture integration* (subject rearranges four quadrants of a single photograph);
8. *Figure analogies* (subject reasons, using visual figures);
9. *Position orientation* (subject recognizes right and left-hand objects from drawings of the objects in a variety of positions);
10. *Shadow identification* (subject identifies geometric figures from the shadows they cast);
11. *Logical reasoning* (subject judges correctness of conclusions drawn from general statements).

In additional tests Chalmers found highly significant correlations between the candidate's photo-interpretation abilities and his abilities in general mathematics, mechanical principles and arithmetic reasoning; somewhat lower correlations were found with respect to aerial orientation, visualization of manoeuvres and ability in the general sciences. Chalmers states (American Society of Photogrammetry, 1960) that other factors which ought to be considered in selection procedures are the interpreter's capacity for learning, adaptability and powers of judgement. The interpreter who cannot readily acquire and retain information is evidently a poor risk. The successful interpreter can change pace, concentrate in difficult circumstances and make intelligent use of his knowledge. As Chalmers points out, these abilities are very difficult to evaluate in testing, however.

Personnel at the Forestry and Timber Bureau in Canberra, Australia, have devised tests to be used in the selection of the most suitable personnel for training in photo-interpretation (Sims and Hall, 1956). One of these, a "photo reading" test, involves the direct recognition, through stereoscopic examination of aerial photos, of various natural and artificial objects with which the candidate ordinarily would have some familiarity from ground observation. Examples are a bridge, dam, wharf, church, lighthouse and railroad turntable. Another, known as a "photo-interpretation" test, involves the ability to deduce or "interpret", from features which can be readily recognized, the meaning of other features or objects which usually cannot, by direct study of their images, be readily identified. Examples are a bus depot, an electric power station, a sewage plant and a rifle range. In other tests the candidates are given small portions of aerial photos and are asked to locate the corresponding portions of the terrain on aerial photos or maps which are usually of a different scale from the small photos. All of these tests correlate well with the candidate's eventual performance as a photo-interpreter. In terms of over-all mental acuity, these investigators recommend that the candidate have an intelligence quotient of 120 or higher.

Similar work is currently being undertaken by personnel of the US Army's Personnel Research Branch of the Adjutant General's Office under the title "Human factors studies in image interpretation". Some of the first results of this work are soon to be published by Martinek, Raney, Schwartz and Castelnovo (1961).

Tests of the candidate's attitude toward the photo-interpretation task

It is encouraging to see that at least a limited amount of attention finally has been given to this important human factor. Rabben (1960) states:

"Often the supervisor is aware only dimly or not at all of his subordinates' undesirable attitudes and poor motivation, and of the extent to which these factors interfere with efficient performance. Suppose, for example, that an aerial photograph images an object *x* which is important for a particular type of photo-interpretation. Many human factors determine whether or not a given interpreter will report object *x*. Assume that object *x* was not reported and the interpreter is then asked 'What about this object?' (while pointing to object *x*). If the response is 'That's object *x*. I didn't see it. I should report it', it may be inferred that the interpreter failed to find *x* in the photograph, either because he was careless or tired, or because the image was too small or otherwise obscure to attract his attention. . . . If the response is 'That's object *x*, I saw it. I didn't think it should be reported', we infer that the importance of *x* is not known to the interpreter. If the response is 'That's object *x*. I saw it. I know it's important. I didn't bother to report it', we infer a lack of interest in the job or a lack of motivation. If the response is 'I didn't know what that object was when I saw it', we infer that knowledge of object *x* is deficient. These brief and oversimplified examples only begin to uncover the human factors at play in the activities of photo-object identification."

Chalmers states that the Air Force's previously-mentioned research programme included a measure of motivation (American Society of Photogrammetry, 1960). It consisted of a number of statements about students' behaviour, e.g., "sleeps in class", "does outside reading", "volunteers information in class". Two or more instructors were asked whether the statement applied to each student always, often, frequently, seldom or never. The scores on this measure were highly related to most measures of photo-interpretation performance. The student who never slept in class, always did outside work and frequently volunteered information in class, was most likely to detect and identify images in photography.

Improvements in photo-interpretation training methods and materials

Once the photo-interpretation candidate has been selected, there still remains an important requirement to train him properly to do photo-interpretation work. Significant progress also has recently been made in this important aspect of the problem.

The Intermountain Forest and Range Experiment Station of the US Forest Service has recently published a document entitled "Training handbook, basic techniques in forest photo interpretation" (Moessner, 1960). This consists primarily of a series of practical photo-interpretation problems involving forest inventory and related aspects of photo-interpretation. For each problem, an

acceptable solution is given and the basic photo-interpretation techniques illustrated by the problem are emphasized. The manual is in such a form as to permit its use either for group study or for self study by those interested in acquiring basic knowledge of photo-interpretation.

Cheney (1960) has made a survey of training in photo-interpretation at present being conducted in the United States and elsewhere. By pooling the information obtained from sixty-three instructors, he has done much to summarize meaningful opinions regarding the best way to train students in photo-interpretation work.

RECENT IMPROVEMENTS IN PHOTO-INTERPRETATION EQUIPMENT

Photo-interpreters need equipment for three general purposes: viewing, measuring and transferring or recording detail. Viewing instruments provide either stereoscopic or two-dimensional views; measuring instruments may be used on single photographs or stereoscopic pairs, and instruments which record or transfer detail do so either through use of the "camera lucida" principle, by projection, or by means of a pantograph.

An excellent, up-to-date summary of each of these types of photo-interpretation equipment has been published by Pickup (1960). The summary provides a graphic indication of recent progress in this area. Among the types of *viewing equipment* which he discusses are stereoscopic viewing instruments, monocular magnifiers and light tables; among the types of *measuring equipment* which he discusses are items devised for making linear measurements, those for making height measurements and those for making area measurements from aerial photographs, and among the types of *equipment for transferring and recording detail* he considers separately those designed for transferring detail from single photographs, and those for stereoscopic pairs of photographs. Also discussed are rectifiers, lamps, dividers, plotting templates, slotted templet cutters, dot counters, sound recorders and photo-interpreter's slide rules, all of which are assuming increasing importance in many kinds of photo-interpretation work. Most of these types of equipment are very well illustrated in Pickup's article.

In the quadrennial report by the President of Commission VII of the International Society of Photogrammetry, Coleman (1960) describes several of the more important new types of instruments being used by photo-interpreters including light tables, rear-projection viewers, high magnification equipment and electronic plotters coupled with analogue or digital computers. He points out that a great amount of the photo-interpretation work now being done uses photographic transparencies rather than opaque paper prints. The transparencies are viewed with rear illumination, usually with the aid of a *light table*. This system has the following advantages: (a) since much of the detail to be interpreted is rendered in dark tones on a positive photograph, the use of rear-lighted transparencies permits better image illumination than is obtained with reflected light on paper prints; (b) the absence of paper grain in film transparencies permits greater magnifications to be used without loss of the image, and (c) the use of connected-roll transparencies avoids the sorting and filing problems inherent in handling separated paper prints.

The increased use of transparencies has led to the development of *rear-projection viewers*, specifically designed for

photo-interpretation use. These instruments usually provide for a standard magnification of the image during projection (four, eight, or as high as twenty times). Many of them permit measurements to be made through the reading of rectangular or polar co-ordinates on devices which traverse the projected image (Coleman, 1960). These measuring devices are easily fitted with magnetic tape for automatic plotting or electronic computation, as explained in a later paragraph. Some rear-projection viewers have a stereo-projection capability.

Careful film processing and the use of transparencies has permitted photo-interpreters to employ *high-magnification equipment*. Among the more successful devices offering high magnification are microscopes modified for the stereo viewing of photographs. These have varying magnifications, usually starting at about eight diameters, and extending, through the use of turret lenses or the zoom magnification principle, to a magnification of forty diameters or more.

The photo-interpreter frequently has the requirement of making a planimetric drawing of his data, either to an arbitrary scale on plain paper or to a specified scale on an existing map. This problem is often facilitated through the use of a *digital computer system*. The photograph is laid on an *x-y* co-ordinatograph, equipped with magnetic read-out heads, so that the successive positions of the cursor as it traces out the detail interpreted from the photograph, are punched into computer tape. According to Coleman (1960), the programmed operation of the computer may be designed to rectify data from oblique photography to the vertical. After the calculations have been completed, the output tape from the computer is fed into a second *x-y* plotter, which plots the new position of each point.

An *analogue system* has been devised which works in much the same way except that both plotters are connected directly to an analogue computer without a punched tape step intervening. The use of an analogue computer permits unrectified line material to be traced in its rectified position in a single, continuous operation.

Bernstein (1960) has reported on a *parallax factor alignment chart*. From the chart a parallax factor is read as a function of the focal length of the taking camera, altitude of photography and photo base length. This factor then converts parallax differences, as measured on the photographs, to heights or differences in elevation between two points.

Statistical sampling through the use of photo plots constitutes an important aspect of modern inventory methods (Rogers, 1960; Allison and Breadon, 1960; Smith, Lee and Dobie, 1960; Lee, 1960; Wolff, 1960). Consequently, *computing machines* are also being employed by photo-interpreters to make multiple correlation analyses, derive multiple regression equations and determine the statistical reliability of various sizes of samples and methods of sampling. Such equipment is making possible the employment of photo inventory sampling methods that heretofore could never have been used because of their unknown statistical reliability.

Any account of recently developed aids to photo-interpretation must make mention of the "*keys*" and *related reference materials* that have recently been published. These keys are designed to facilitate the rapid and accurate identification of various objects and conditions from a study of their photographic images. They commonly

consist of two parts (Colwell, 1952): (a) a collection of annotated or captioned stereograms and other photos which are illustrative of the objects or conditions to be identified, and (b) a graphic or word description which sets forth in some systematic fashion the photo recognition features of those objects or conditions. Recently published examples are the keys and similar aids prepared by Avery (1960b), Miller (1960), Moessner (1949), Wilson (1960) and Sayn-Wittgenstein (1960, 1961). A selected, annotated bibliography of aerial photo-interpretation keys to forests and other natural vegetation has been prepared by Choate (1957).

RECENT IMPROVEMENTS IN THE METHODS AND TECHNIQUES OF PHOTO-INTERPRETATION

Before considering *new* techniques, it would be well to emphasize that much yet needs to be done to master the *long-established* and highly necessary techniques used in interpreting aerial photographs, including the following.

Methods for orienting a stereo model beneath the stereoscope. The objective should be to accomplish this act quickly, yet in such a way as to permit the most realistic three-dimensional impression to be obtained of the model, while avoiding unnecessary eye strain for the photo-interpreter. Although most photo-interpreters have long since developed the ability to accomplish this orientation, most of them could greatly improve their ability in this respect if they were to analyse the waste motions and other inefficiencies in their habitual procedures. The recently developed photo alignment guide (Moessner, 1960) is of genuine assistance in improving this technique.

Methods for handling a large stack of photos in an orderly manner during the photo-interpretation process. The advantage of some system for the orderly progression of photos from one position to the next, as a large stack of them is being interpreted, can be very great. The advantage is apparent, however, only when contrasted with the haphazard crossings over and rotations of prints that usually ensue when an interpreter simply plops down a stack of photos and starts interpreting them. A detailed description of one approved procedure appears in the article by Rabben (1960).

Methods for avoiding duplication or omission in the interpretation of areas common to two or more stereoscopic models. This is of such importance in the interpretation of end lap areas common to two successive photos in a flight line, or of sidelap areas common to two adjacent flight lines as to permit a reduction of from 30 to 50 per cent in the photo area which otherwise would be interpreted. The technique required here is that of delineating the "effective area" of each photograph (or of alternate photographs in some situations). The effective area is that portion of a photograph which is imaged more nearly towards the centre of the photo in question than it is to the centre of any other photograph, either within the line of flight or in adjacent flight lines.

Methods for systematically searching the area encompassed by a stereo model. At present no particular search method can be recommended above all others. Nevertheless, it is important that the photo-interpreter settle upon some systematic search pattern to be certain that each area of the stereo model is examined at least once, but not unnecessarily more than once.

Other methods and techniques. One of the most encouraging signs of recent progress in this aspect of

photo-interpretation is to be found in the "Training plan for developing basic techniques in forest photo interpretation" (Moessner, 1960). It is revealing to enumerate the thirteen problems comprising this training plan, as they constitute a good summary of the more important basic techniques. They are: stereo-perception test; positioning photos for best stereo-vision; recognition of ground cover conditions; determining photo scale; determining project scale and flying height; determining bearing and distance on aerial photos; determining relative elevation by parallax wedge; measurement of tree and stand heights by parallax wedge; estimating crown diameter and crown coverage; estimating board foot and cubic foot volume on sample plots; dot sampling for areas; direct volume estimates from aerial photos; measuring slope percentages, and road planning on photos.

Although it is not within the province of this paper to report in detail relatively to each of these many techniques, evidence of significant progress is to be found in the mere fact that the techniques used by a photo-interpreter for a specific purpose are being categorized and carefully studied.

A LOOK TO THE FUTURE

In any report that deals primarily with progress recently made, it is only natural to conclude with a report of progress still anticipated. As we attempt to peer into the future we are, perhaps, fortunate that only a hasty summary of anticipated progress can justifiably be included in a paper such as this. For experience has shown us that even photo-interpreters with the highest visual acuity can scarcely claim 20/20 vision when peering into the crystal ball to predict the future. The following, therefore, represents only one photo-interpreter's terse predictions of types of progress soon to be made in the use of aerial photographs. Consistently with the sequence followed in the preceding portions of this report, the predictions are made for each link in the chain, from the taking of aerial photography to the eventual production of a photo-interpretation report.

The aerial photography used in the future will be of a far more diverse nature than heretofore

For the first time, *extremely small-scale photography* taken with a photo reconnaissance satellite from an altitude of nearly 200 miles will be available for civil as well as military photo-interpretation work. Even though this photography may permit us to do little more than discover and evaluate, in crudest terms, the natural resources in vast and remote areas, it will be of tremendous value in helping to plan for the economic growth of underdeveloped countries.

Our newspapers tell us, presumably on good authority, that eventually photography taken from reconnaissance satellites will provide clarity of detail, expressed in terms of "ground resolution",² nearly as good as that now obtainable with conventional aerial photographs. If photography of this quality can be obtained for civil use, somewhat as a by-product, from a satellite sent into orbit primarily for military reconnaissance, a quicker and more economical means of obtaining information than is at present available may come into being.

² Ground resolution is the ground size equivalent of the smallest photographically resolved pattern of regularly repetitive detail, such as the bars on a resolution target.

Such high-altitude photography may not exhibit sufficient relief displacement for the measurement of object heights by stereoscopic parallax; however, for this very reason, it will provide a far more accurate photo map representation of large areas than that offered by even the most accurate photo mosaics made with conventional aerial photography, on which problems of relief displacement are very great.

Likewise, extensive use probably will be made in the future of *extremely large-scale photography*, taken from helicopters of precisely located "sample plots", on which the agriculturist, forester, soil scientist or other photo-interpreter wishes to make detailed studies. Avery (1958) is among those already pioneering the use of this kind of photography.

In addition, through multiband spectral reconnaissance, use will be made of several photos taken simultaneously of the same area, from the same aircraft, with a variety of photographic films and filters. Already photo-interpreters have found that much more complete information about an area can be obtained when two or more such types of photography are interpreted in concert, than when only one type is available for study (Colwell, 1961).

Photo-interpreters will be much more rigorously selected and trained in the future than heretofore

The previously-mentioned studies by Sims and Hall at the Timber and Forestry Bureau in Canberra, together with the work being done by Moessner and others, provide ample evidence that such measures are needed. Future testing will recognize the fact that the photo-interpreter typically must work continuously for several hours at a time, without the accuracy of his work being allowed to diminish appreciably through human fatigue. Therefore, greater emphasis will be placed on testing the candidate's visual and mental acuity over a long work period, instead of relying so heavily, as at present, on his "flash" performance.

The equipment used by photo-interpreters will be of a greatly improved nature

There will be an acceleration of efforts to perfect equipment permitting the photo-interpreter to view transparencies rather than opaque prints, and full colour images rather than monochromatic ones. Rheostats for adjusting light intensity will become standard equipment, and a carefully prepared series of optical glass filters will be available for viewing various features on colour transparencies.

The conventional lens-stereoscope will still be used in the field, but in the office it will be replaced by viewing devices which offer variable magnification over a large range. Furthermore, stereoscopes of the future will not require the photo-interpreter to examine photography for prolonged periods with his neck bent, as at present, as this restricts the flow of blood to his brain, thereby impairing his visual and mental acuity.

The initial reporting of a photo-interpreter's observations will commonly be made with the aid of sound recording machines rather than with archaic pencil and paper; with this aid he no longer will need to look away from the photo image and thus interrupt his continuity of thought and photo study. Increased speed and accuracy of interpretation will surely result from this improvement.

The techniques used in interpreting photographs will be commensurate with these improvements in equipment

The specific techniques will no longer be dependent on the individual whims and bad habits of the photo-interpreter. Through scientific testing of alternate techniques under carefully controlled conditions, accurate information will be available for the first time on which to base recommendations for standardized optimum techniques.

There will be a great increase in the number of applications made of aerial photo-interpretation

It would be inaccurate to state that there are countless fields in which photo-interpretation has not yet been applied, and in which it soon will be applied. To the contrary, it seems that one or more investigators have already dabbled with photo-interpretation, for better or worse, in virtually every field wherein it might conceivably be used. In the past these attempts have often been unsuccessful primarily for two reasons: (1) the investigators have been misled by overly enthusiastic statements from which they inferred that photo-interpretation is the complete arm-chair solution to all information gathering problems on the face of the earth, and (2) the investigators have known too little regarding the techniques of photo-interpretation and consequently have been unable to extract from the photos a great deal of the information which more competent photo-interpreters could have obtained. Because of their unwarranted high hopes and their unnecessarily dismal initial failures, these investigators have, in many instances, become so disillusioned as to abandon all further consideration of aerial photography as a useful tool, and have persuaded many of their colleagues to do likewise. Consequently, before the prediction made in this paragraph can come true, this disillusionment must be overcome, primarily through application, by highly competent photo-interpreters, of the sound principles and techniques which this paper has attempted to describe.

The day will probably never come when a photo-interpreter can merely sit in the comfort of his office and, by sheer photo-interpretation, make a complete and reliable analysis of all the objects and conditions with which his study is concerned. There is no complete substitute for a careful on-the-ground study. The photo-interpreter who forgets this important fact will soon suffer serious embarrassment, however good his aerial photos, however superior his visual and mental acuity and however sophisticated his photogrammetric instruments and techniques. But with due appreciation of these limitations and through application of the principles and techniques recently made available to him, he can place photo-interpretation on a much sounder footing in the future than it has been in the past.

To summarize. Very significant progress has recently been made in all facets of aerial photo-interpretation. As a result, the photo-interpreter can now report his findings with much greater confidence than in the early days when he was forced to rely heavily on compensating errors and empirical good luck as he attempted to use this relatively new tool, the aerial photograph.

With the additional progress that we are now on the threshold of making, and mindful of the fact that there is no complete substitute for field work, we can look forward with confidence to an ever-brightening future for aerial photographic interpretation.

REFERENCES

- Allison, G. W. and Breadon, R. E., Timber volume estimates from aerial photographs, B.C. Forest Serv., For. survey note 5 [1960], 25 p. 1960
- American Society of Photogrammetry, Manual of photographic interpretation, Washington, D.C [1960], 859 p. R. N. Colwell, chief ed. 1960
- Avery, Gene, Helicopter stereo-photography of forest plots, *Photogrammetric engineering* 24(4):617-624 1958
- Avery, Gene, A checklist for airphoto inspections, *Photogrammetric engineering* 26(1):81-84 1960a
- Avery, Gene, Identifying southern forest types on aerial photographs, Southeast. For. Exp. Sta. Station paper 112 [1960], 12 p. 1960b
- Bernstein, D. A., A parallax factor alignment chart, Pacific Northwest For. Range Exp. Sta. Research note 183 [1960], 4 p. 1960
- Cheney, Ted A., Education and training in photo interpretation, Chapter 16 of American Society of Photogrammetry's Manual of photographic interpretation, p. 817-834 George Banta 1960
- Choate, G. A., A selected annotated bibliography of aerial photo-interpretation keys to forests and other natural vegetation. *Jour forestry* 55:513-555 1957
- Coleman, Charles G., General summary report of Commission VII (photographic interpretation) to the International Society of Photogrammetry. *Photogrammetric engineering* 26(2):278-282 1960
- Colwell, Robert N., A systematic analysis of some factors affecting photographic interpretation *Photogrammetric engineering* 20(3):442-448 1954
- Colwell, Robert N., The future for photogrammetry and photo interpretation. *Photogrammetric engineering* 25(5):712-736 1959
- Colwell, Robert N., Some practical applications of multiband spectral reconnaissance. *American scientist* 49(1):9-36 1961
- Colwell, Robert N. and Marcus, Leslie F., Determining the specifications for special purpose photography. *Photogrammetric engineering* (in press) 1961
- Dominguez, Oscar, A comparative analysis of color and black-and-white aerial photography as aids in the mapping of soils in wildland areas. In Manual of photographic interpretation, p. 396-402 1960
- Dwornik, Stephen E. and Orr, Donald G., In-situ spectrophotometric data and its correlation with tone contrast on aerial photographs. *Photogrammetric engineering* (in press) 1961
- Fischer, W. A., Color aerial photography in photogeologic interpretation. *Photogrammetric engineering* 24(4):545-549 1958
- Guy, W. C., Increasing the effective speed of Ektachrome Aero Color-Film. *Photogrammetric engineering* 36(4):609 1960
- Jackson, K. B., Factors affecting the interpretability of air photos. Paper 9th Internat. Congress Photogram., London, England, 16 p. 1960
- Langley, Philip G., Predicting photographic tone and color contrasts through use of the IBM 704 computer to make statistical analysis of spectrophotometric data. (Conversations with the writer.) 1961
- Lee, Yam, To assess the possibility of applying aerial stand-volume multiple regression equations for the application of photo-mesurational techniques on several kinds of air photos. Univ. British Columbia, Vancouver, B.C. Doctoral dissertation 1960
- Lyons, E. H., Preliminary studies of two camera, low elevation stereo-photography from helicopters. *Photogrammetric engineering* 26(4) 1960a
- Lyons, E. H., 70 mm helicopter stereo-photography. Paper 6 Dec. 1960 meeting of Puget Sound Region, Amer. Soc. Photogram. 6 p. (typescript) 1960b
- Macdonald, Duncan E., Interpretability. *Photogrammetric engineering* 19(1):102-107 1953
- Macdonald, Duncan E., Resolution as a measure of interpretability. *Photogrammetric engineering* 24(1):58-62 1958
- Martinek, Harold, Ranes, John E., Schwartz, Alfred I. and Castelnovo, Anthony E., Human factors studies in image interpretation. *Photogrammetric engineering* (in press) 1961
- Maruyasu, T. and Nishio, M., Experimental studies on color photographs in Japan. Report Instit. Industrial Science, Univ. Tokyo, Tokyo, Japan. 8(6) 1960a
- Maruyasu, T. and Nishio, M., On the study and application of infra-red aerial photography. Report Instit. Industrial Science, Univ. Tokyo, Tokyo, Japan. 10(1):1-16 1960b
- Miller, R. G., The interpretation of tropical vegetation and crops on aerial photographs. *Photogrammetria* 16(3):232-240 1960
- Moessner, Karl E., Stereograms illustrating forest sites. US For. Serv. Central States For. Exp. Sta. Miscellaneous publication 4 1949
- Moessner, Karl E., A simple test for stereoscopic perception. US For. Serv. Central States For. Exp. Sta. Technical paper 144. 14 p. Also in *Photogrammetric engineering* 21(3):331-339 1954
- Moessner, Karl E., Training handbook. Basic techniques in forest photo interpretation. Intermountain For. Range Exp. Sta. Unnumbered publication. 73 p. plus training kit 1960
- Pickup, Jack, Equipment for photo interpretation. In American Society of Photogrammetry's Manual of photographic interpretation, p. 148-168. George Banta 1960
- Rabben, Ellis E., The eyes have it. *Photogrammetric engineering* 21(4):573-578 1955
- Rabben, Ellis E., The fundamentals of photographic interpretation. Chapter 3 of American Society of Photogrammetry's Manual of photographic interpretation. George Banta 1960
- Rogers, E. J., Forest survey design applying aerial photographs and regression techniques for the Caspian forests of Iran. *Photogrammetric engineering* 26(3):441-443 1960
- Sayn-Wittgenstein, L., Recognition of tree species on air photographs by crown characteristics. Canadian Dept. of Forestry, Technical bulletin 95. 56 p. 1960
- Sayn-Wittgenstein, L., Phenological aids to species identification on air photographs. Canadian Dept. of Forestry, Technical bulletin 104. 26 p. 1961
- Sims, W. G. and Hall, N., The testing of candidates for training as air photo interpreters. Commonwealth For. Tim. Bur., Canberra. 12 p. plus 6 plates, 1 map 1956
- Smith, J. H. G., Lee, Yam and Dobie, J., Intensive assessment of factors influencing photocruising shows that local expressions of photo volume are best. *Photogrammetric engineering* 26(3):463-469 1960
- Spurr, Stephen H., Photogrammetry and photo-interpretation. With a section on applications to forestry. New York, Ronald Press. 472 p. 1960
- Tarkington, Raife, Kodak panchromatic negative films for aerial photography. *Photogrammetric engineering* 25(5):695-699 1959
- Veruette, Jesus F., Factors affecting the estimation of timber volumes from aerial photographs. University of California, Berkeley, California. Unpublished thesis 1961
- Wilson, Richard C., Photographic interpretation in forestry. Chapter 7 of American Society of Photogrammetry's Manual of photographic interpretation, p. 457-520. George Banta 1960
- Wolff, G., Zur Verbesserung der Methodik von Holzvorratsinventuren mit Hilfe des Luftbildes. *Archiv f. Forstwesen* 9(4):365-380 1960

INVESTIGATIONS IN THE USE OF COLOUR PHOTOGRAPHY FOR GEOLOGIC PURPOSES

Background paper by William A. Fischer, United States Geological Survey

Colour photography has many geologic applications, but the solution of some types of interpretive problems is more likely to be aided by the use of colour photography than is the solution of others. The solution of interpretive problems that largely relate to landform analysis or problems wherein topographic position is the paramount recognition element, as, for example, in mapping the distribution of small streams, is not likely to be facilitated appreciably by the use of colour photography. Conversely, interpretive problems involving variations in the colour, pattern or texture (to which colour contributes significantly) of the surface, are likely to be greatly

facilitated by use of colour photography. The sketch maps in figure 99 contrast the total lengths of streams and roads that can be mapped from comparable colour and black-and-white photography in a small area in east-central New Mexico. There is little difference in the number or length of streams that could be recognized on the two kinds of photography. The roads, however, are recognizable by virtue of their contrast in texture and, possibly, colour from their surroundings and thus a much greater number of roads are visible on the colour photograph than on the black-and-white photograph.

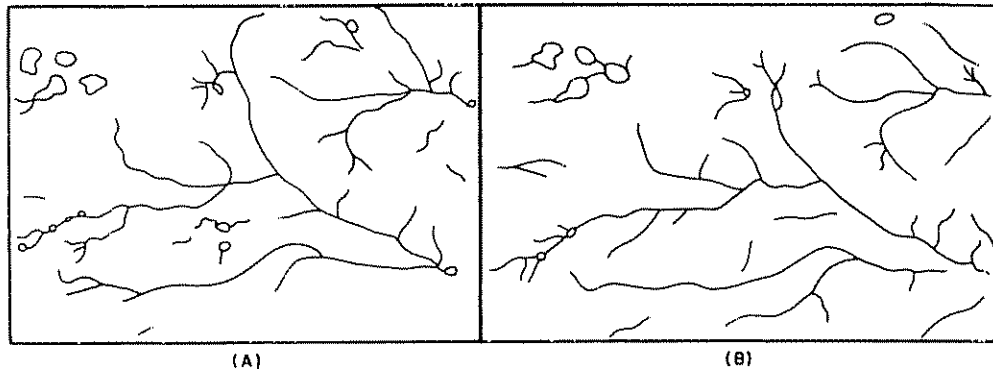

I

The total length of streams that could be mapped from conventional black-and-white photography (A) and colour photography (B) in the same area in east-central New Mexico. Original scale of black-and-white photography is approximately 1:32,000; original scale of colour photography is approximately 1:22,000

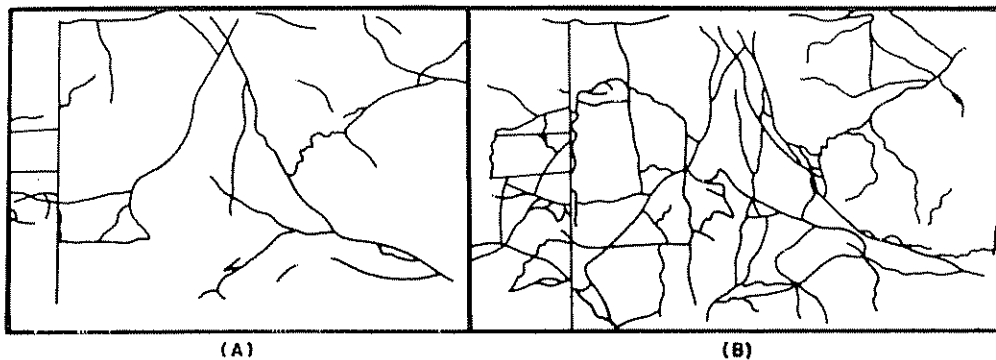

II

The total length of roads and trails that could be mapped from conventional black-and-white photography (A) and colour photography (B) of the same area in east-central New Mexico

Figure 99. Sketch maps showing different degrees of effectiveness of colour photography in different types of map coverage

In addition to its demonstrated usefulness in a conventional interpretive sense, colour photography has great potential value as an intermediate product in the preparation of specially designed black-and-white photography and as a source of quantitative geologic information.

There are many methods of colour measurement and many applications of such measurements to geologic study. Three such techniques and applications are discussed in outline form below.

1. *Problem: To facilitate mapping of the distribution of rock units, in this example the Bernal and San Andres Formations in an area in east-central New Mexico.*

Setting: the Bernal Formation, a thin reddish-coloured siltstone, overlies the grey limestone of the San Andres. Field mapping by ground methods alone would be time consuming because Bernal occupies much of the topographic surface and the surface is dissected and uneven relative to the thickness of the Bernal Formation. The rocks of the two formations are not separable on conventional black-and-white photographs [figure 100 (I)] and their distribution is difficult to map from the colour photographs.

Procedure: (a) Samples of rock believed representative of the colours of the formations are collected in the field;

(b) Colours of rock samples are determined by colorimeter analysis [figure 100 (II)];

(c) Colour measurements are contrasted to determine the part of the spectrum wherein the greatest difference in total reflection of light occurs (in this example the greatest difference between the light reflected from the Bernal and San Andres Formations [units B and C in figure 100 (II)] is in the 450-520-millimicron part of the spectrum);

(d) Photographs of rock samples are taken using panchromatic film and filters (wratten filters numbers 47 and 48) that permit the passage of light in only the 460-520-millimicron part of the spectrum (Ray and Fischer, 1960, page 147, figure 5; Fischer, 1960, page 138, figure 61.2). The resultant photographs showed marked tone contrast between the samples and verified the significance of the colour measurements;

(e) Black-and-white copy of the colour photograph of the area is prepared using panchromatic film and the same filter combination used in step "d".

Result: The resultant black-and-white copy of the colour photograph [figure 100 (III)] shows sharp tone contrast between rocks of the two formations. Figure 100 (IV) is a close-up view of point A on figures 100 (I) and (III) and shows that a small amount of exposed rock will present a sharp tone contrast on properly designed photographs.

Conclusion: the distribution of the Bernal Formation on the surface of the San Andres Limestone can be more easily and more accurately mapped from specially prepared black-and-white photographs than from the colour or conventional black-and-white photographs or by field methods. Variations in the photographic tone associated with the Bernal Formation [figure 100 (III)] may be related to the thickness of the formation and thus could be measured with a densitometer.

2. *Problem: (i) To map the distribution of rock units, in this example the Glorieta Sandstone and the San Andres Limestone in an area in east-central New Mexico, and (ii) to assess possible relationships between colour and structural setting.*

Setting: the Glorieta Sandstone is overlain by the limestones of the San Andres. The topography is typical of much of the mesa-canyon country of the south-western United States; most of the mesas in this area are capped with limestone. The contact between the sandstone and limestone is irregular as a result of local solution and subsidence. The two formations are difficult to distinguish on conventional black-and-white photographs [figure 100

(V)] and on colour photography. The distribution of the two units can be readily mapped by conventional field methods.

Procedure: (a) Rock samples were selected that were believed to be representative of the colours of the two rock units [units A and B of figure 100 (II)]. The colours of the rocks were measured with a colorimeter; results suggested that the sandstone reflected more red light than the limestone. Test photographs of the samples made with panchromatic film and a filter that passed only red light (Ray and Fischer, 1960, page 147, figure 6; Fischer, 1960, page 138, figure 61.3) confirmed this difference in total reflectance of red light.

(b) Three identical traverses were made across a colour transparency of the area with a colour densitometer. The amount of red, green and blue light passing through the transparency was recorded separately.

(c) The records of the amount of red, blue and green light passing through the transparency along the line of traverse were superimposed [figure 100 (VI)].

(d) To assess possible colour-structure relationships, a series of measurements of the divergence of the red and blue records was made along those parts of the traverse that were underlain by sandstone. Using arbitrary units, the percentage difference between the two records was computed and plotted at numerous points along the original traverse line [figure 100 (VII)].

Results: areas underlain by sandstone were marked on the combined colour record [figure 100 (VI)] by a sharp increase in the amount of red light that passed through the colour transparency and a related decrease in the amount of blue light that passed through the transparency. An anticlinal axis crosses the line of traverse striking in a direction approximately normal to the direction of traverse. The percentage difference between red and blue light increased along the traverse in the direction of the axis and was greatest at the axis [figure 100 (VII)].

Conclusions: the positions of the contact between the Glorieta Sandstone and the San Andres Limestone along the line of traverse can be determined by measuring the relative amounts of red and blue light transmitted through a colour transparency.

The sandstones near the axis of the anticline traversed by the colour densitometer reflect more red light than do the sandstones on the flanks of the structure. This may relate to a local depression of the water-table and consequent greater oxidation of the iron-rich sandstones. This suggests a method of structural study of special value in areas of poor outcrop.

3. *Problem: to map the distribution of rocks that had been subjected to hydrothermal alteration in an area near Goldfield, Nevada.*

Setting: the area is underlain primarily by a sequence of Tertiary volcanic rocks; many of the rocks have been subjected to hydrothermal alteration. Field investigations, related studies of the colour photography and related petrographic studies disclosed that (1) the lithology of relatively unaltered rocks in this area could be recognized by colour on colour photographs; (2) the original lithology of highly altered rocks could not be recognized by colour on the colour photographs, but the degree of alteration could be ascertained. The more highly the rocks were altered, the more red they appeared to be.



I

Conventional black-and-white photograph of an area in east-central New Mexico underlain by grey limestones of the San Andres Limestone and red siltstones of the Bernal Formation. Point *A* shows the location of ground photograph (IV)

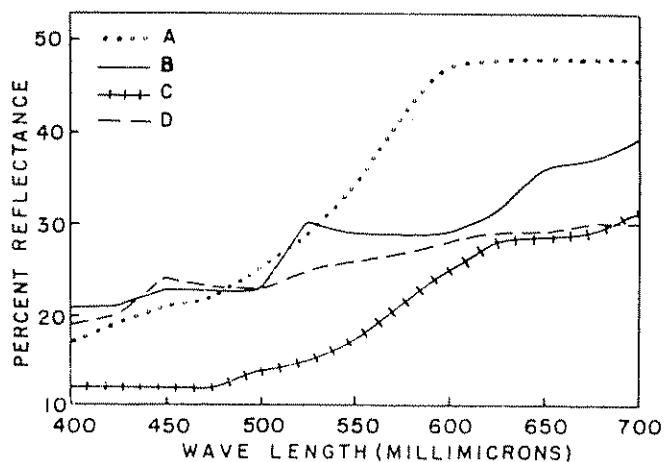

II

Spectral reflectance curves of fresh samples of Glorieta Sandstone (light brown sandstone) (*A*), San Andres Limestone (grey limestone) (*B*), Bernal Formation (red, shaley siltstone) (*C*) and Dockum Formation (grey sandstone) (*D*)



III

Part of an ektachrome transparency photographed through filters that pass only light in the 460-520-millimicron part of the spectrum. The dark grey areas are underlain by siltstone of the Bernal Formation; the light grey areas are underlain by the San Andres Limestone. Point *A* shows the location of ground photograph (IV)

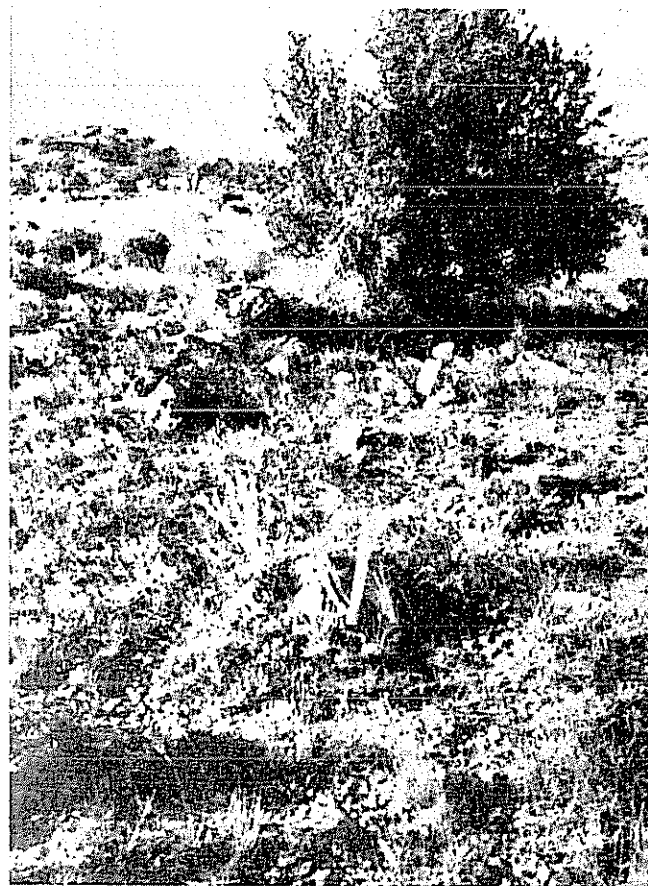

IV

Close-up view of point *A* on I and III. Boulders are of the San Andres Limestone

Figure 100. Methods of colour measurement and their application to geologic study

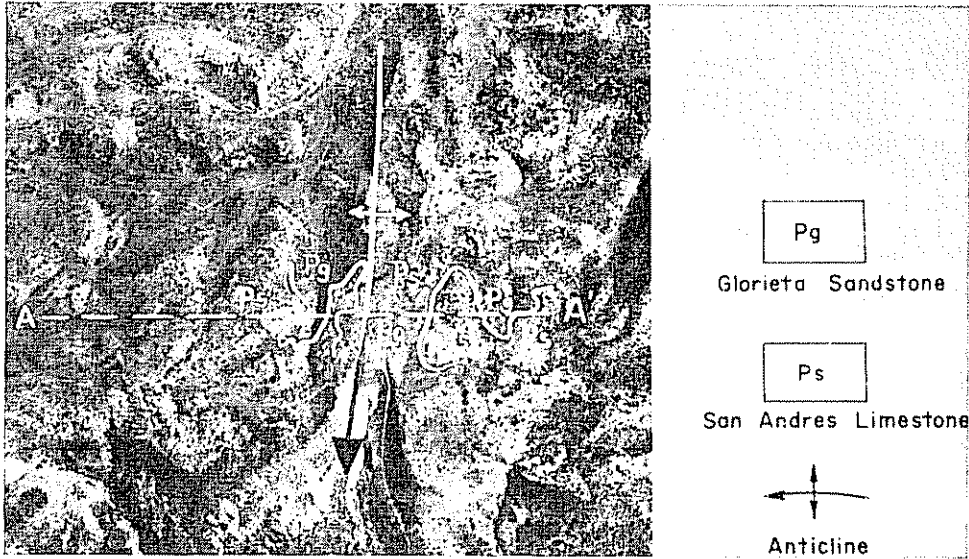

V

Black-and-white photograph showing area in east-central New Mexico underlain by Glorieta Sandstone and the San Andres Limestone of Permian Age. The line A-A' marks the location of a colour densitometer traverse

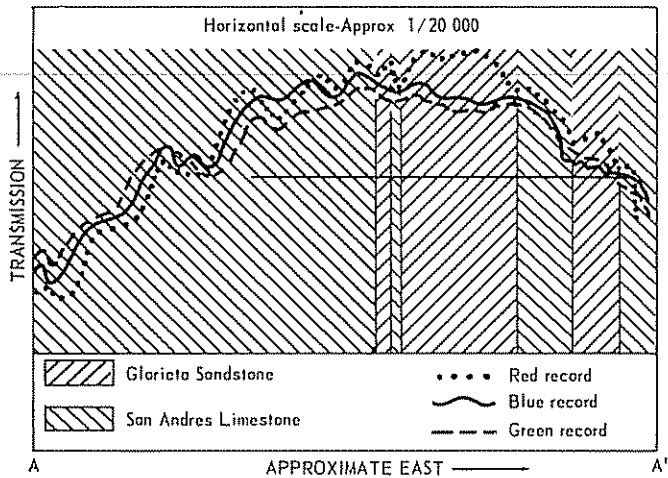

VI

Chart showing the relative amounts of red, blue and green light passing through a colour transparency along the line A-A' shown in V. The broad curve of the lines represents the general light distribution characteristics of the lens in the taking camera

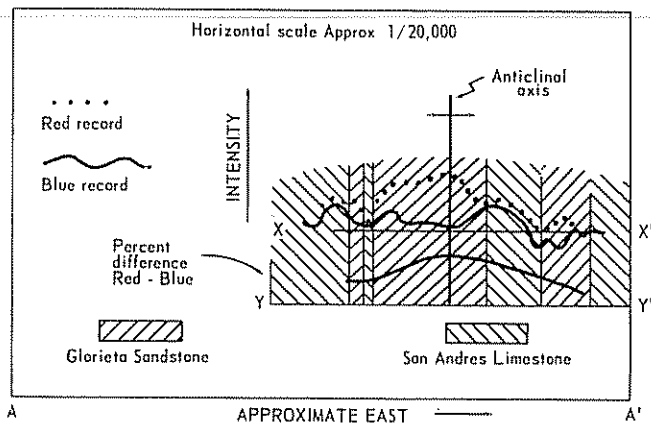

VII

Chart showing relative amounts of red and blue light passing through a colour transparency along part of line A-A' shown in V; relative amounts of red and blue light referenced to a fixed transmission value (X-X'): relative amounts of red and blue light measured in arbitrary units, expressed as percentage difference, and referenced to the position of the axis of an anticline (Y-Y')

Procedure: (a) Colour measurements were made from colour transparencies of areas of known lithology and alteration. These measurements showed that the highly altered rocks reflected less blue light than the unaltered rocks;

(b) Because the highly altered rocks reflected approximately the same amount of red light as some bright unaltered rocks but much less blue light, a black-and-white copy of the colour photograph was made using panchromatic film and a filter that passed only blue light;

(c) A film positive was made from the resultant negative and, through the co-operation of the United States Naval Photographic Interpretation Center, placed in an RCA image enhancement device. (This device permits enhancement of minor tone differences and outlines electronically all parts of a photograph having the same tone value.)

Results: the photograph placed in the image enhancing device was observed and rephotographed at three settings. At the first setting, areas believed to be the most intensely altered (the darkest grey tones) were outlined electronically [figure 101 (A)]. At the second setting [figure 101 (B)], rocks believed to be in an intermediate stage of alteration (intermediate tones) were outlined.

Alignments of some of the outlines, such as that shown by X-X' on figure 101 (B), suggest association of linear structural elements (probably faults) with the pattern of alteration. At the third setting [figure 101 (C)], rocks believed to be relatively unaltered (lightest grey tones) were outlined. Because the photograph includes some areas not visited in the field, the results of this experiment cannot be considered fully verified.

Conclusions: Subtle colour differences on colour photographs can be enhanced by printing specially designed black-and-white copies and employing image enhancement techniques for viewing the black-and-white duplicate. Parts of the original photograph having similar colour characteristics can be outlined electronically.

REFERENCES

- W. A. Fischer, "Reflectance measurements as a basis for film-filter selection for photographic differentiation of rock units", *Short Papers in the Geological Sciences*, US Geol. Prof. Paper 400-B, 1960, Art. 61, pages B136 to B138.
- R. G. Ray and W. A. Fischer, "Quantitative photography—a geologic research tool", *Photogrammetric Engineering*, v. 26, No. 1, 1960, pages 143 to 150.

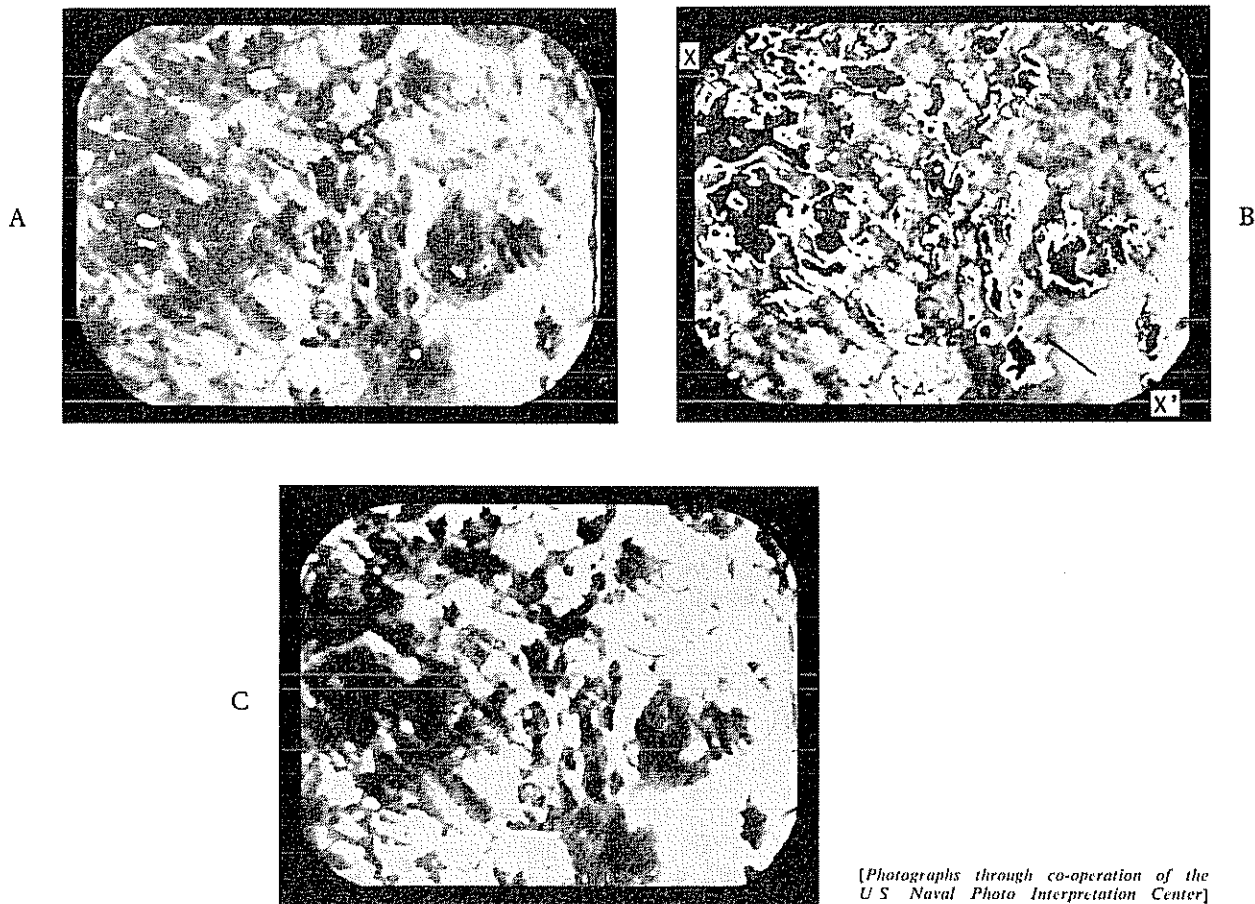

Electronic outlines show areas of approximately equal tone value: (A) areas of dark grey tone (greatest alteration); (B) areas of intermediate grey tone (intermediate alteration), and (C) areas of light grey tone (little alteration). Alignments of some outlines, such as those along X-X' in (B), suggest association of structural elements with pattern of alteration

Figure 101. Photographs of image on display tube of image enhancement device

(b) Exchange of interpretation key and material among regions lying on the same climatic belts and zones

EXCHANGE OF INTERPRETATION KEY AMONG REGIONS LYING
ON THE SAME CLIMATIC BELTS AND ZONES¹

Proposal submitted by Thailand

THE INFLUENCE OF CLIMATES

Geographically, climate is the most influential element of the earth's environment. The location of an area on the surface of the earth tells one immediately to what climatic region it belongs. The barren lands of Africa and central Australia indicate that they have an arid, or a desert, climate. The coniferous forests of North America give evidence that they are in the continental climate zone. The red lateritic soil of Thailand gives a clue that it is in the rainy part of the country. These obvious examples illustrate how climate influences the surface of the earth.

NEED FOR PHOTO-INTERPRETATION KEY

Since much of the earth's surface has not yet been mapped, aerial photography seems the most efficient means of expediting mapping programmes at present. In order to interpret aerial photographs a photo-interpretation key is needed for a guide-line.

The difficulty of aerial photo-interpretation is that much of an area cannot be completely checked on the ground due to its vastness or inaccessibility, or both; the dense jungles of the tropical rain forests are an example. Although some photographs may have been interpreted using the local key, there still remain regions near international frontiers which cannot be photo-interpreted without access to the key used across the border particularly in the case of photo-geological interpretation. There are examples of difficulties which make the result of interpretation doubtful and inaccurate, but these problems can be overcome if the countries which have been covered by aerial photographs agree to exchange their interpretation keys. Furthermore, a key could help to solve the interpretation problem efficiently and economically.

ADVANTAGES OF THE KEYS

Photo-interpretation keys are helpful in many branches of geographic interpretation, among them the following:

1. Vegetation covers;
2. Soil types;

¹ The original text of this paper appeared as document E/CONF. 36/L.19.

EXCHANGE OF MATERIALS AND REVELANT INFORMATION AMONG REGIONS LYING
ON THE SAME CLIMATIC BELTS AND ZONES¹

Proposal submitted by Thailand

The use of aerial maps, alone or in combination with aerial photographs, has aroused the interest of men in various branches of government whose activities particularly involve the use of land with its varied physical and cultural features.

¹ The original text of this paper appeared as document E/CONF. 36/L.22.

3. Geology;
4. Geomorphology;
5. Settlement patterns.

With these, various kinds of photo-interpretation can be speeded up and topical maps of good quality prepared. It is economical to exchange interpretation keys, as this reduces the expense of field sampling for detail similar to that in another country. It will also help in solving problems of inter-related regions, i.e., geologic structures which cannot be interpreted from the photographs of limited areas alone. There will also be certain features which exist in one country but not in others; an exchange of keys can give the kind of confirmation needed. Lastly, photo-interpretation keys may also benefit many branches of geographical education.

SUGGESTED PROCEDURES

The representatives of interested countries should initiate work on this project immediately upon their return, each branch of experts collecting and arranging the photo-samplings in good order. The reports of the samplings should also be checked and edited. For economy on the project, the experts should select the key for any photo details which may be questionable, or for which the sampling work may be difficult—for example, trees in thick jungle—and for details in an easily accessible region which is believed to have some relationship with other regions across the border, say, rock types in a region of synclines where an international river runs along its basin.

The experts should take the responsibility for compiling the keys together with the reports and for having them ready for exchange at the Fourth United Nations Regional Cartographic Conference for Asia and the Far East. If the experts cannot continue the work, then they should ask their successors to do so.

The technical committee should draw up a resolution on this project and decide on the materials and format of the report which the experts or representatives of the interested countries will contribute at the next conference.

Finally, it is hoped that if this attempt is successful it will be possible in the future to compile the stereoscopic and anaglyphic atlas based on the collected keys for photo-interpretation.

boundaries, buildings, roads, plant cover in clusters or in wide expanses of forest, isolated villages and farms. However, not all countries are fortunate enough to have the facilities and the means of acquiring such a wealth of material and information. Would it not, therefore, be desirable at present to increase the interchange of knowledge, techniques and keys for the use of aerial photographs?

There are many ways an object on the ground may be recognized in an aerial photograph, by its shape, dimension, tone, texture, pattern, location and context. When a photo-interpreter examines either a single photograph or a stereoscopic pair of photographs, he utilizes a variety of devices, including hand or mounted lenses and various types of stereoscopes, in order to obtain the largest amount of information.

But a photo-interpreter can only be as good as the man who develops and prints the aerial photographs. A really highly trained photo-interpreter must be one who possesses varied and long field experience as well as good visual and high mental acuity. If he knows the physical and cultural features of an area, he can identify every spot in an aerial photograph rapidly and accurately. But since the physical and cultural aspects of the land mean trees, soils, rocks, hills, rivers, towns, etc., photo-interpreters should be drawn from among foresters, soil technologists, geographers and community planners, as well as military and aeronautical personnel. Such a complex organization of specialists should be able to exchange information in order to speed up and facilitate progress in the use of aerial photographs.

The following features are some on which photo-interpretation information might be exchanged: transportation; drainage; surface configuration; natural vegetation; agriculture; rural non-agricultural features; urban features; soils and land utilization, and geologic features.

Knowledge of these will be very useful in helping the countries concerned to lower the cost of living, raise the level of their economies and increase the well-being of their people.

Photo-recognition and photo-interpretation are both based on one important factor, that is, the human factor. The interpreter or observer should have good visual ability and intelligence. The ways and means by which he arrives at a decision are of basic importance.

Objects on aerial photographs are recognized through pictorial elements, the most important of which are shape, dimension, tone, texture, shadow, location and association. One or more of these elements will serve to identify an object; they are not easy to explain and their interpretation must be learned through experience.

Photo-interpreters will use both recognition by experience and equipment for photo-interpretation. Such

items of equipment as the mirror stereoscope, lens stereoscope or pocket stereoscope are the most important, as well as templates, stereograms and keys.

Although, in the field of photo-interpretation, the ability to recognize details cannot be exchanged, some of the equipment for photo-interpretation, such as stereograms and keys, can be exchanged. It can most usefully be exchanged between countries lying in the same climatic belt or zone, because they will have the same or nearly the same features of transportation, drainage geology, soil, natural vegetation, agricultural crop and the like.

As mentioned above, photo-interpretation is a recent development and as such it is probable that the sources of material and equipment will vary from one country to another. Photo-interpretation is usually done with an aerial photograph of an area which is already familiar to the interpreter on the ground. What he sees in an aerial photograph is the vast area, in minute detail, as though he himself were in an airplane. The view on the aerial photograph astounds him on first sight; then he gradually gains knowledge of the ground features as shown in the photograph. And now the scales and many other aspects of aerial photography are being critically studied and perfected to such an extent that maps have been drawn from aerial photographs alone just through the establishment of well-controlled stations or points on the ground. With the aerial photographs and maps made from them, go the different symbols, signs, markers or legends which represent the different physical and cultural features of the earth. At later stages, from the same ground area, the interpreter finds that his work assumes a more accurate form, and that much less time is required for the preparation of the final map. But in order to carry out this work uniformly, he must have signs, symbols and other characteristic legends to represent certain types of land features. Uniform symbols, stereograms and keys for countries of the same climatic zones should be discussed and agreed upon during this meeting.

The exchangeable material in photo-interpretation will be the stereogram or photo-interpretation key which the specialist prepares for use in his own country. The exchange of such material will be most useful in the case of other countries lying in the same climatic zone and in which the same natural conditions are found.

The preparation of stereograms or photo-interpretation keys is very well known to most photo-interpreters. It would be better if punch cards or stereogram record cards could be used for purposes of exchange.

REFERENCES

- Stephen H. Spurr, *Forestry Aerial Photography* (1945) and *Photogrammetry and Photo-interpretation* (1960).

AGENDA ITEM 15

Topical maps

(a) Review of new techniques and developments

TOPICAL MAPS AND NATIONAL ATLASES¹

Information paper submitted by China

In compliance with resolutions 27 and 28 of the Second United Nations Regional Cartographic Conference for Asia and the Far East, held in Tokyo in 1958, an atlas of China and some topical maps have been compiled by the provincial government of Taiwan and certain scientific organizations. The following have already been published:

1. Atlas and Topical Maps of Taiwan;
2. Atlas of the Republic of China (Editor-in-chief, Dr. Chang Chi-yun):
Vol. 1, Taiwan;
Vol. 2, Hsitsang and Sinkiang;
Vol. 3, North-eastern, Northern and North-western Parts of China;
Vol. 4, Central, Southern and South-western Parts of China;
Vol. 5, General Maps of China;
3. Forest Maps of the Taiwan Sea Coast and Farm Windbreak, scale 1:25,000, numbering 122 sheets;
4. Forest and Land Use Map of Taiwan, scale 1:50,000, numbering 102 sheets;
5. Stand Size and Problem Area in Taiwan, scale 1:50,000, numbering 102 sheets;
6. Land Use Capability Survey of Marginal Zones (for elevations of from 100 to 1,000 metres) between Forest

and Crop Land in Taiwan, scale 1:20,000, numbering 183 sheets.

In addition, the soil survey for land capability was carried out between 1953 and 1959 on forest and agricultural marginal land lying between the plains and mountains less than 1,000 metres above sea level. The lands thus surveyed covered a total area of about 14,000 square kilometres. The soil maps made on the basis of this survey do not show any contours. Land resources surveys in limited areas have also been made in recent years by the provincial agencies concerned. The data gathered in the soil, land use and forestry surveys need to be supplemented by more detailed surveys, since the topical maps mentioned above can only be used for general purposes. For obtaining basic information to facilitate the local planning of economic development and investment, detailed surveys of land use, including surveys of geomorphology, surface geology, the drainage system, valley and gully density, gradient distribution and soil, must be carried out at the earliest possible date.

It has been found that the surveying of natural resources entails tremendous survey and cartographic work which is too heavy a burden for an under-developed country. Assistance from outside the country, in particular from the United Nations, would be very helpful. It is therefore hoped that the United Nations Technical Assistance programme, including the Special Fund programme, will give special support to a resources survey project.

¹ The original text of this paper appeared as document E/CONF. 36/L. 65/Rev.1.

METHODS OF PREPARATION AND PRODUCTION OF TOPICAL MAPS¹

Technical paper submitted by Thailand

I. THE GEOLOGICAL MAP OF THAILAND

Geology and minerals

The Geological Map of Thailand can still be regarded as a reconnaissance map. The first complete official map was compiled in 1949, on the scale of 1:2,500,000, from reconnaissance surveys along the routes leading to reported economic deposits. Some of the surveys were done using the 1:1,000,000-scale map, some with a "provisional" 1:200,000 map and some with a map on the scale of

1:253,440 which was published by the United States of America during the Second World War. Although the dividing lines between the sedimentary formations are unreliable, the age assignment is rather more definite, due to the fossil collections, which proved to be quite rich in comparison with those of neighbouring countries, with the exception of the large plateau of north-east Thailand (about one-third of the country in area), where a formation tentatively named the "Khorat Series" covers the whole area, but where no identifiable fossil has as yet been found.

Determination of the age of igneous rocks presented quite a problem, and the assignment was based on the

¹ The original text of this paper appeared as document E/CONF. 36/L. 15.

phenomenon of contact with sedimentary rocks believed to be identical in age, lithologically, with other distant formations where fossils have been found and identified.

The map was prepared as a basis for future systematic work in regional geological surveys when and where reliable maps at 1:50,000 scale become available.

The mineral map is on a scale of 1:2,500,000 and should be regarded only as a mineral occurrence map; no attempt has been made to indicate the economic importance of any one mineral or its metallogenic affinity.

Conventional signs, legends and romanization

All maps produced by the Royal Department of Mines use romanization in accordance with the Gazetteer to maps of Thailand, which was compiled by the joint efforts of the United States Board on Geographic Names and the Royal Thai Embassy in Washington and published in December 1944. A new system of romanization currently being prepared by the Royal Thai Survey Department of the Ministry of Defence will be adhered to in the future.

Conventional signs and legends have been based on United States Geological Survey practice, but in the near future the international standards set up by various committees of the International Geological Congress will be adopted.

Regional projection system

The delegation of Thailand wishes to propose the adoption of the scale and projection system adopted at the second meeting of the Working Party of Senior Geologists on the preparation of a regional geological map for Asia and the Far East, held from 5 to 10 June 1956 in Tokyo, Japan. The scale is 1:5,000,000 and the projection is the Lambert Conformal Conic projection with original latitude 15° N.

II. THE CLIMATIC MAP OF THAILAND

Before going into detail regarding the Climatic Map of Thailand, it is appropriate to mention that a blank map of Thailand has been supplied to the Meteorological Department of the Royal Thai Navy with a request that the principal climatic data of Thailand be filled in. The map is on the scale of 1:1,000,000 and on the polyconic projection. Speaking only with regard to the field of climatology, and particularly for regions close to the equator, maps on the Mercator projection are generally in use at various scales depending on particular climatic elements, the density of stations and the like as a means of presenting a summary of knowledge of the climate in a form suitable for a wide variety of users.

The Climatic Map is on the scale 1:1,000,000 and it includes essential geographical information; however, it proved impossible to show all the climatic elements of Thailand on it. It was decided, therefore, to insert in the map certain climatic elements and main features only as basic material which will enable most users to obtain a broad picture of the climate of the country, thereby helping them to frame their requests for further information.

The Climatic Map under consideration shows the following essentials:

1. The climatic classification of Thailand;
2. The rainfall régime;
3. The seasonal variation of temperature.

The manner of preparation and presentation are as follows.

1. On climatic classification, Koppen's classification has been adopted, because, unlike most others, it is a quantitative system which uses numerical values for defining the boundaries of climatic groups and types so that the boundaries can be checked and revised as new data become available. This method is based on the monthly and annual mean temperatures and the annual precipitation with the times of its maximum. Letter symbols have been chosen corresponding to certain limits of the two elements to facilitate the grouping. Most climatic types are described by three letters, the combination of which is called the climate formula. These letter symbols in the map referred to have the following meanings:

A: humid tropical climate. Coldest month above 18° C (64° F);

AF: tropical rainforest climate. No monthly rainfall below 60 mm;

AM: tropical monsoon climate. Short dry season with driest monthly rainfall below 60 mm;

AW: tropical savannah climate with long winter dry season. Driest monthly rainfall below 60 mm.

2. Regarding the rainfall régime, stepped curves are used and plotted from monthly mean values for the period from 1932 to 1957. Only some selected stations are plotted in order not to congest the map area. The procedure represents the regional climate very well. Annual rainfall is also given below this diagram.

3. The seasonal variation of temperature is shown in line curve and plotted from monthly mean values.

III. MAPS OF POPULATION AND TOWN PLANNING

Drawing of population maps

The map to be used is on the scale 1:1,000,000 on the polyconic projection; it is compiled from plane table survey maps on scales of 1:25,000 and 1:50,000 and from 1:200,000 maps.

Sources of data

Data are obtained from the nation-wide survey made by the National Economic Development Board and from the Ministry of the Interior.

Use of the map

The map will be used for planning rural economic development, in particular by the National Economic Development Board and the Ministry of the Interior, and by all other ministries, public bodies and departments.

Suggestions concerning correction and improvement

In drawing population maps it is necessary to obtain the data on population in each Changwad, Ampur, Tambhol and village. However, the population survey should be based on town plans on about 1:1,000 scale, which show the number of each building as a basis for the survey. The drawing of population maps, therefore, also involves town planning.

Drawing of town plans

Due to lack of certain equipment and facilities for photogrammetry, the drawing of town plans has been done by interpretation of terrain from control mosaics. They are usually drawn at 1:1,000 in municipal areas and 1:5,000 in other areas.

Projection

The Universal Transverse Mercator projection is used.

Use of the map

Completely drawn maps are used within the Ministry of the Interior for such purposes as police work, municipal work, electric work, telephone service and waterworks, as well as by the National Economic Development Board.

Suggestions concerning correction and improvement

A training course in interpretation of projection for town planning should be organized for the benefit of the officials concerned. In addition, aerial photographs of crowded areas should be taken at least once every three years because the terrain is constantly changing.

IV. FOREST TYPE MAPS

The topical maps of Thailand showing forest types are prepared from information collected by the divisional and provincial forest officers stationed in different parts of the country. This information has been obtained not from any type of inventory but through the observations of the local forest officers who are generally familiar with the tree species found in their localities. Therefore, without a systematic inventory of forest resources, the figures for the extent of the forests and the tree species found in them cannot be accepted as statistically correct. However, these topical maps will be further revised after the completion of the six-year national forest inventory project.

The forests of Thailand are classified according to climatic conditions. The decisive factor is the humidity prevailing in each region. The forests in the regions which have more rainfall will consist of tropical evergreen, whereas in the regions with scanty rainfall, which have distinct dry and wet seasons and low humidity, the forest will be deciduous. Thus, in the south and east of Thailand, which are closer to the equator, nearer to the sea and have a heavier rainfall, the forests are generally tropical evergreen. In the inland regions, which are far from the equator and have distinct dry and wet seasons, for example, in the north-east and the north, the forests are generally of the deciduous type. The evergreen forests are confined to the wetter areas, such as stream banks and valley lands in swampy ground. Approximately 70 per cent of the forests in Thailand are of the deciduous type, and the remaining 30 per cent are tropical evergreen. The forests as classified and shown in the topical map are as follows:

(a) *Tropical evergreen forests.* This type of forest is found throughout Thailand and reaches its greatest development in the south and south-east.

The vegetation composing this type of forest is very rich in species and is of a most diversified character. Among the timbers of commercial importance the following may be mentioned:

Andericum indicum
Azelia xylocarpa
Ailanthus fauveliana
Amoora polystachya
Anisoptera oblonga
A. scaphula
Artocarpus calophylla
A. lokoocha
Balanocarpus heimii
Calophyllum floribundum
C. inophyllum

C. pulcherrimum
Cedrela toona
Cinnamomum iners
C. parthenoxylon
Cotylelobium lanceolatum
Dalbergia cochlin chinensis
Dipterocarpus alatus
D. baudii
D. costatus
D. dyeri
D. grandiflorus

D. incanus
D. kerrii
D. kunstleri
D. pilosus
D. turbinatus
Fagraea cochlin chinensis
Hopea ferrea
H. odorata
H. pierrei
H. recopei
Intsia bakeri
Lagerstroemia
L. balansae
L. calyculata
Litsaea grandis

Mesua ferrea
Michelia champaca
Parashorea stellata
Phoebe paniculata
Shorea cochlin chinensis
S. curtisii
S. glauca
S. gratissima
S. guiso
S. hypochra
S. leprosula
S. parvifolia
S. sericea
S. weiseri
Vatica cineria
V. wallichii

This type of forest is very important to the country. In addition to being the source of valuable timbers and fuel, the tropical evergreen forests also supply most of the commercial forest products, such as rattans (*Calamus* spp. esp. *C. caesius*), dammars, gamboge, gutta-percha, wood oil, cardamoms, jelutong, incense wood, bamboos, dhaulmoogra oil, corypha leaves and phung-ta-lai fruits.

(b) *Pine forests.* These forests are found in the northern and north-eastern parts of the country at elevations of 700 to 1,000 metres and above, and are also found occasionally mixed with trees of the deciduous Dipterocarps type. The growing stock of these forests is composed mainly of two species of pines, *Pinus khasya* and *Pinus merkusii*, the latter descending to a much lower altitude than the former.

(c) *Deciduous forests.* Deciduous forest both of the mixed deciduous and the deciduous Dipterocarps types are found throughout northern, central and north-eastern Thailand. These forests thrive on quite a variety of soil types and are not very selective as regards site and elevation. They are found on the plains as well as on the hills, but they rarely grow above an altitude of 1,000 metres. They may be broadly divided into two types:

- (i) Mixed deciduous, and
- (ii) Deciduous Dipterocarps

(i) *Mixed deciduous forests.* The teak bearing mixed deciduous forests are found mainly in the northern part of the country. As a type, the forests are among the most valuable potential assets of the country; teak and many valuable timbers known in international trade are derived from them. Bamboos, which occur in great abundance in this type of forest, are themselves an important article of local trade.

The following are the principal commercial timbers:

Acacia catechu
Adina cordifolia
Azelia xylocarpa
Albizia lebbek
Dalbergia bariensis
D. domingensis
D. oliveri
Diospyros mollis
Erythrophloeum succiruum
E. teysmanii
Gardenia cellinsae
Nauclea orientalis
Pterocarpus macrocarpus
Tetrameles nudiflora
Vitex peduncularis
V. pubescens
Wrightia tomentosa
Xylia kerrii
Xylocarpa

Apart from timber, these forests are also sources of various forest products, such as fibres, crude drugs and food, which are valuable contributions to the lives of the rural population.

(ii) *Deciduous Dipterocarps forests.* These forests occupy vast tracts in the northern, central and north-eastern

parts of the country. The general appearance is of a somewhat open character, with the trees of medium size and height. The soil, which is generally gravel, sand or laterite, has a profound influence on the composition of this type of forest.

The tree species are more or less mixed, though pure associations, particularly of *Pentacme siamensis*, *Shorea obtusa*, *Dipterocarpus tuberculatus*, *D. obtusifolius* and *D. intricatus*, occur and are of good growth.

Economically, these forests are among the most important resources of the country and are the principal sources of fuel, posts and timber for heavy construction and for the domestic and export trade.

Other commercially important species in addition to those previously mentioned are *Sindora siamensis*, *Terminalia tomentosa*, *Shorea floribunda* and *Irvingia malayana*.

Important minor forest products obtainable from the deciduous Dipterocarps forests are dammars, wood oil, nux vomica seeds, paramarium oil and resin.

(d) *Mangrove forests.* The coastline of the country is mainly occupied by mangrove forests. The important species in these forests belong mostly to the family Rhizophoraceae, of which the following are representative:

<i>Bruguiera conjugata</i>	<i>Ceriops roxburghiana</i>
<i>B. cylindrica</i>	<i>C. tagal</i>
<i>B. parviflora</i>	<i>Rhizophora candelaria</i>
<i>B. sexangula</i>	<i>R. mucronata</i>

Other important associates are:

<i>Avicennia alba</i>	<i>Xylocarpus moluccensis</i>
<i>A. officinalis</i>	<i>X. obovatus</i>
<i>A. tomentosa</i>	

The forests are of very great commercial value, being highly productive per unit of area and easily accessible by water. They supply the bulk of the fuelwood and charcoal for export to foreign markets as well as for home consumption in the coastal towns and in Bangkok itself. Besides fuel and charcoal, they also provide a small amount of timber for construction and for use in coastal fisheries.

Tanbarks derivable from the vegetation of these forests are also very valuable and widely exported. The best species for tanbark is the *Ceriops roxburghiana*.

(e) *Savannah.* This type of forest is found in some of the plain regions of the country. The vegetation composing this type of forest is of no value from the forestry point of view.

V. CADASTRAL MAPS

The Department of Lands, under the Ministry of the Interior, was organized about 1902. There are three types of land documents which the Department now issues. The first is called a "Land certificate". Land certificates certify right of ownership. All juristic acts and registration must take place at the Changwat (town or city) land offices of which there are seventy-one in Thailand. The certificates must show the names and addresses of the owners, the map, area and location, and the position of the land with respect to the national co-ordinate system. The certificates must be certified by the Changwat land officer and countersigned by the governor.

The second type of document certifies that the land is fully developed and it gives the owner the right of possession. All registrations of these documents and juristic

proceedings in connexion with them must take place at the district (Ampur) sheriff's offices. The documents show only the names, addresses, locations, approximate areas and very rough sketches of the lands.

The third type is a grant permitting persons to occupy and develop the land which they claim. It gives only a partial right to the land for a period of time.

The approximate area of the country is about 511,937 square kilometres. At the end of 1960, the Department of Lands had issued land documents as follows:

1. The first type of document, that is, "Land certificates", covering 21,529 square kilometres (1,029,241 pieces of land) or 4.21 per cent;

2. The second type of document covering 7,820 square kilometres (368,428 pieces of land) or 1.53 per cent;

3. The third type of document covering 12,606 square kilometres (451,303 pieces of land) or 2.46 per cent.

There are still about 53,392 square kilometres or 10.44 per cent of free land holdings for which no type of document has been issued.

The topical map is based on the Royal Thai Survey Department's one-millionth map. The Department of Lands has divided the country into nine land administrative regions: Region 1, Central Region; Region 2, South-eastern Region; Region 3, Eastern Region; Region 4, North-eastern Region; Region 5, Northern Region; Region 6, Upper Central Region; Region 7, Upper Southern Region; Region 8, Southern Region; Region 9, Lower Southern Region.

VI. SURVEYING AND MAPPING FOR WATER RESOURCES DEVELOPMENT PROJECTS IN THAILAND

Introduction

Surveying and mapping play a key role in appraising a river basin development project, because it is obvious that accurate topographic maps are a prerequisite for all the basic engineering information needed in the river development works. Planning of the utilization of water resources is greatly handicapped when basic data are inadequate. In fact, the ultimate success or failure of a water resources development project can depend on the availability of adequate surveying and mapping works pertaining to it.

In constructing water control structures to impound, divert, regulate, distribute or control river water so that the water can be utilized effectively, various types of surveys and maps are required. Maps showing river catchments to determine the available supply and hydrological features of the basins may be needed first. While the seasonal distribution of water controls project size, the areal distribution of water resources often dictates the location of the project and its structures. All phases of the engineering works to be undertaken afterwards, such as planning, design, construction, operation and land acquisition, require a certain type of survey and maps prepared specifically for them.

Types of maps and scales

Geodetic surveying and mapping in Thailand have been conducted by the Royal Thai Survey Department, a national agency which provides the basic framework of horizontal and vertical controls for the country. The

Thailand, Department of Lands: data on lands with certificates, developed lands and other

Region	Area with certificates		Developed area without certificates		Forest land, waste land, bodies of water and public land		Total area of region (square kilometres)
	Square kilometres	Percentage	Square kilometres	Percentage	Square kilometres	Percentage	
1	9,233.12	45.50	602.37	2.97	10,454.51	51.53	20,290
2	4,276.76	11.33	2,063.51	5.47	31,397.72	83.32	37,738
3	174.86	0.21	28,289.06	34.93	52,531.05	64.86	80,995
4	19.15	0.02	15,072.25	17.73	69,914.18	82.25	85,006
5	256.85	0.26	3,895.28	3.93	94,871.87	95.81	99,024
6	2,181.34	3.01	12,424.15	17.15	57,831.51	79.84	72,437
7	5,214.33	11.35	1,217.15	2.65	39,494.51	86.00	45,926
8	86.94	0.21	4,773.33	11.51	36,626.73	88.28	41,487
9	85.47	0.29	5,486.68	18.90	23,461.85	80.81	29,034
TOTAL AREA	21,528.86	4.21	73,823.78	14.42	416,583.94	81.37	511,937

Department also produces maps that are used as base maps for planning and supervision in general. The base maps which have been available as a prerequisite to river development, both for hydrology and for detailed surveying and mapping of the project area, are as follows:

(a) 1:25,000 topographic maps with 25-metre contour interval and spot elevations, covering part of the country;

(b) 1:50,000 topographic maps with 20 to 25-metre contour interval and spot elevations, also covering part of the country;

(c) 1:200,000 topographic maps showing only a little culture and highly generalized, covering the entire country;

(d) 1:250,000 topographic maps, usually known as "AMS Maps".

These maps have been compiled from recent aerial photography. Contour intervals vary, some sheets having a contour interval of 100 metres with an intermediate contour of 50 metres and others a contour interval of 50 metres with an intermediate contour of 25 metres. These maps cover almost the whole country.

For the purposes of hydrological studies of river drainage basins, topographic maps on scales of from 1:25,000 to 1:250,000 should be adequate, depending on the size and location of the basins.

For assessing the theoretical hydro-power potential of a river basin, topographic maps of 1:50,000 or larger, having contour lines at 10 to 20-metre intervals, may be used as base maps.

Precise levelling is considered a key element in river basin development works. In designing the irrigation and drainage system over the vast flat plain of the Chao Phraya River, maps are enlarged to 1:20,000 and spot levels are run on the ground for supplementary contouring at intervals of from 0.50 metre to one metre, according to the slope of the land.

Aerial mapping has been introduced for the reservoir studies in a river valley development works to determine the reservoir flow and to assess the storage capacity of the reservoir. The scale and contour interval adopted for the

topographic flow map often depend on land value, concentration and the magnitude of the improvement needed in the area. Regarding the estimate of the storage capacity of the reservoir, the scale and contour interval of the map used depend a great deal on the slope of the terrain. Usually, a reservoir map of 1:25,000 with 5 to 10-metre contour interval has been used by the Royal Thai Irrigation Department. Considerable gain in reservoir storage capacity is often observed after the scale and contour interval of the reservoir map used have been improved.

The storage capacity of the Lake Mead Reservoir in the United States of America was increased by about 1,800,000 acre-feet after the reservoir map had been enlarged from a 50-foot contour interval on a scale of two inches to one mile to 5 and 10-foot contour intervals on a scale of one inch to 1,000 feet.

Large-scale mapping of the dam site or head-work is also needed for site planning and design of installations. Site plan maps having scales between 1:500 and 1:2,000 with contour intervals ranging from one to two metres following the land slopes have been used in the Royal Thai Irrigation Department.

Control system for irrigation work

Horizontal control

The detailed 1:20,000 contour maps of 0.5-metre interval for irrigation and drainage design purposes are prepared by the Royal Thai Irrigation Department. The horizontal control system of these maps is referred to the Royal Thai Survey grid systems of plane co-ordinates. The standard accuracy established for horizontal control work is of second-order. The main traverse control lines are proposed at six to eight kilometres apart routed in loops along sheet boundary with cross traverse lines spaced at two kilometres apart running through the loops in a north-south direction. At each traverse station, 400 metres apart on each traverse line, a bench-mark is driven into the ground as a reference point. At the corners of the main loops the standard bench-marks, 0.20 by 0.20-metre concrete blocks two metres long, are also established as permanent bench-marks for construction work.

Vertical control

One of the important phases in the survey operation is the precise levelling. The Royal Thai Irrigation Department operates its vertical control on the basis of the vertical control system established by the Royal Thai Survey Department. Levelling work is of second-order accuracy, and is based upon mean sea level datum. The level is routed along each traverse line, so that the elevation may be read on each traverse station established. Ground elevation is often read at the auxiliary points located 100 metres apart along the traverse lines, so that the denser network of spot levels may be obtained in preparing the 1:20,000 map.

Details

Topographers are instructed to obtain the best results regarding details in the area surrounding each control station. Particularly for streams, cross-sections at 100 to 500-metre intervals, profiles showing the state of flow, water levels in dry and flood seasons, and historical flood-marks have to be compiled in the course of the survey.

Preparation and reproduction of irrigation maps at 1:20,000

Maps are usually prepared on mapping sheets each 0.70 by 0.90 metre in size. The 1:20,000 scale is generally adopted. The rectangular grid system is first laid out on the map sheet with the values of co-ordinates shown at each 400-metre interval.

The horizontal control points are plotted on the grid by co-ordinates. The latitude and longitude of the origin of the co-ordinates are always indicated on each map sheet.

After the horizontal control has been established, spot elevations at each control point are entered. The finished maps show spot elevations in depressions and on hilltops. In general, contour lines of 0.5-metre interval are shown. At some places where the full interval contours fail to express correctly topographic shapes, contour lines of 0.10-metre interval are also inserted. All necessary cultural features are portrayed, including highways, railroads, trails, canals, streams, villages, Wads (Buddhist temples), cultivated lands, woodlands, lagoons, power lines, etc. Streams less than five metres wide are represented by single lines; klongs and rivers are drawn to scale. The finished maps are then transferred on to the tracing papers and reproduced from inked tracings.

Conclusion

Topographical surveying and mapping are necessary in connexion with our water resources development programmes; complete topographic information should be available for our comprehensive river basin planning. Maps adequate for the standard required for river planning are now available for a small part of the river basins. Detailed project maps on a scale of 1:20,000 with contour interval of 0.5 to one metre are available for a land area of only 26,000 square kilometres.

The Royal Thai Irrigation Department, however, in close collaboration with the Royal Thai Survey Department, firmly intends to carry out the detailed topographic surveying and mapping of the proposed project areas, so that the programme of national water resources development will be able to keep pace with the increasing demands of the nation.

TYPES AND SCALES OF TOPICAL MAPS¹

Background paper submitted by Thailand

As guidance for the future compilation of topical maps, the following suggestions are presented for discussion.

1. The basic types of topical maps should be decided and the work should commence immediately. The countries without topical maps should be encouraged and assisted to carry on the work of mapping and compilation.

2. Some of the world authorities on regional classification should be consulted and followed.

3. The colour scheme for major regions should be definitely agreed upon together with the designs for the shading of the sub-regions. For ease of identification, the regions should be coded with numbers or letters.

CONVENTIONAL SIGNS, LEGENDS AND ROMANIZATION

1. Topical maps, or a set of such maps, should have the same projection system and scale, in order to facilitate overlapping of the maps for geographical deduction and conclusions.

2. The scales of the maps should be classified so that a complete set of maps can be prepared for each scale. The types and regions to be shown on the map could then be decided. The suggested scales are as follows:

(a) 1:250,000 should be used as a base map for field surveys and land classification;

(b) 1:2,000,000 should be used as a base map for small-scale topical maps of countries having small areas;

(c) 1:5,000,000 should be used as a base map for topical maps of regions or large countries;

(d) all scales smaller than 1:5,000,000 should be used for the compilation of atlases.

The regions to be plotted on each set of maps at the various scales should be classified and agreed upon. This is an important step in topical map compilation. If the regions are broken down into too small subdivisions they cannot be shown with clarity on small-scale maps, i.e., 1:5,000,000 and smaller.

3. The following are suggestions to be considered for the compilation of topical maps:

(a) *Climatic regions*. Koppen climatic classification and regions should be used;

(b) *Geology and minerals*. Rock types and mineral occurrence should be shown on the same map;

(c) *Structural geology*. The structural geological regions should be superimposed with line shading to emphasize the physiographic patterns in accordance with the method used by Professor Erwin Raisz;

¹ The original text of this paper appeared as document E/CONF. 36/L. 17.

(d) *Forest and vegetation.* Major forest classification should be decided and a colour scheme assigned for the classified regions;

(e) *Agricultural or crop regions.* Topical maps should be accurately and independently plotted according to the local distribution of the crops and agricultural systems used, at scales of 1:250,000 or 1:1,000,000. The major agricultural regions should be classified and plotted at 1:5,000,000 and smaller scales;

(f) *Livestock regions.* The map should show regional distribution of domestic animals and symbols of scales of production;

(g) *Population.* This map should show density of population by colour scheme. The position and symbol of chief cities with scale of population should also be plotted. Land transportation systems, including inland waterways, should be shown on the same map; maritime or sea routes can also be shown in order to fill up the otherwise empty open water areas on the map, at the same time giving better emphasis to settlement patterns in accordance with transportation facilities;

(h) *Town plans.* Chief town plans of the region should be compiled with details showing heavily populated areas, industrial regions, commercial regions, parks and playgrounds, residential areas and others. The scales may be selected according to the details to be shown since a town plan is an independent topical map;

(i) *Communication.* The map should show systems of telecommunication with a hypsometric map as the base;

(j) *Air transportation.* The map should show air routes, including distances, and volume of traffic. The base map should be a hypsometric map as in the communication map. If possible, the two maps may be combined into one topical map as a transportation and communication map;

(k) *Hydrology and water power.* The map should show drainage region, volume of discharge, irrigation projects and power stations with an indicated production of power. If possible, it should be plotted on the base map of annual precipitation which will clearly indicate the relationship of the power thus produced.

REVIEW OF REPORTS OF THE WORKING GROUPS ON GEOLOGY, SOILS AND HYDROLOGY OF THE COMMITTEE ON SPECIAL MAPS, COMMISSION ON CARTOGRAPHY, PAN AMERICAN INSTITUTE OF GEOGRAPHY AND HISTORY¹

Background paper submitted by the United States of America

INTRODUCTION

During the Seventh General Assembly of the Pan American Institute of Geography and History (PAIGH), held in Buenos Aires from 1 to 15 August 1961, consideration was given to a series of reports dealing with the discovery and evaluation of natural resources as an aid to economic development. These reports had been prepared by the Working Groups on Geology, Soils and Hydrology of the Committee on Special Maps. The General Assembly approved the reports and adopted a resolution which provides for their future publication as an official document of the Institute, with wide distribution being given to government agencies, universities and libraries throughout the Americas. The Assembly also provided for the creation of a Special Committee on Natural Resources, as an organ of the Institute, to stimulate and guide the Member States in developing their future programmes for natural resource discovery and evaluation. This differs somewhat from the recommendation contained in all three of the reports, which proposed that the Commission of Cartography establish new committees in the various fields of natural resource investigation.

The reports of the working groups stem from a resolution adopted by the Eighth Pan American Consultation on Cartography, which was sponsored by the Commission on Cartography and held in Havana in February 1958. This resolution charged the Committee on Special Maps with the responsibility of collaborating with the Member States in the fields of natural resource investigation and making recommendations as to the future course of the Institute in such matters. The Committee, recognizing the need for the participation and assistance of specialists

in the fields of natural resource investigations for the successful fulfilment of this task, decided that working groups, made up of experts in these fields, should be created to provide the guidance and collaboration needed. As a first step, working groups were created for geology, soils and hydrology.

After the creation of the working groups, it became obvious that their task would be greatly simplified if each group were brought together for discussion and drafting of recommendations for the consideration of the Member States and the Institute. Accordingly, the Chairman of the Committee on Special Maps, Mr. Arthur J. Sweet of the United States, arranged through the Acting Chairman of the Commission on Cartography for the three groups to hold their respective meetings.

The Working Group on Geology met in Washington during June 1959. It consisted of Mr. Carlos Ruiz Fuller, Director, Instituto de Investigaciones Geológicas, Chile, Mr. Guillermo P. Salas, Director, Instituto de Geología, Universidad Nacional Autónoma, Mexico, and Dr. Arnold Mason, Geologic Division, Geological Survey, United States.

The Group on Soils consisted of Dr. Guy D. Smith, Director, Soil Survey Investigations, Soil Conservation Service, United States, Dr. Carlos Diaz Vial, Chief, Sección de Agrología, Departamento de Conservación de Recursos Agrícolas, Chile, and Dr. Luis de Leon, Facultad Agronomía de la Universidad de Uruguay and Técnico del Servicio del Suelo, Uruguay. This group met in Montevideo in April 1961.

The Group on Hydrology met in Caracas in May 1961, and its members were Dr. Alfonso J. Freile, Chief, Departamento de Hidrología de la Dirección de Geología del Ministerio de Minas e Hidrocarburos, Venezuela, Mr. Mario Pacheco, ex-Sub-Secretario de Agricultura

¹ The original text of this paper appeared as document E/CONF. 36/L 53.

y Ganadiria, El Salvador, Mr. Arnaldo T. Stabile, Sub-Director de Estudios y Proyectos de Obras Sanitarias de la Nacion, Argentina, and Dr. George Taylor, Jr., Chief, Foreign Hydrology Section, Geological Survey, United States.

Depending upon the interests of the Member States of the Institute, it is understood that there are plans to create additional working groups in such fields as forestry, fish and wildlife and oceanographic resources.

The following is a brief summary of the material contained in the reports, including the recommendations of the working groups.

GEOLOGY

The importance of mineral resources to the economy of a country was stressed. The extent to which geologic investigations are carried out will determine to a large degree the scope of a country's economic progress.

Types of mineral resources are listed as follows:

1. Metallic minerals;
2. Non-metallic minerals;
3. Fuels;
4. Inorganic fertilizers;
5. Construction materials;
6. Precious stones;
7. Ceramic materials.

Geology is concerned with the study of the mineralogic and chemical composition of the materials of the earth, their origin, arrangement, distribution and structure, including the physical and chemical processes affecting them. One of the first steps in the conduct of a geologic investigation is the production of a geologic map, accompanied by a report which interprets the geology. Regional geologic maps show the areal distribution, structural pattern, boundaries and relationships of the various rocks. Surface geology is plotted on a topographic map which may vary in scale from 1:5,000 to 1:250,000. The geologist uses the geologic map to pinpoint probable areas needing more detailed study and representation.

Geologic information is extremely useful in water resource development activities and in engineering projects of many varieties.

Long-range planning of geologic investigation and mapping is essential. A national policy for minerals exploration should provide for the training of technical personnel. Geologic investigations in the national programme should proceed from a sound knowledge of that already known, through preliminary investigations, to detailed investigations in an orderly progression.

Examples of steps that might be taken in a national programme of geologic investigation are as follows:

1. Collection of available geologic and mining data;
2. Carrying out of vertical aerial photography over entire area (1:20,000-1:60,000 scales). Preparation of mosaic at scale of 1:250,000;
3. Preparation of essential topographic base maps;
4. Preparation of reconnaissance-type geologic maps of selected areas;
5. Preparation of photogeologic maps to outline areas needing more detailed study;

6. Preparation of intermediate scale (1:25,000-1:50,000) maps of areas that appear favourable for valuable deposits;

7. Compilation of general geologic maps (scale 1:250,000) over entire area;

8. Undertaking of detailed geologic investigations;

9. Carrying out of laboratory analysis and research to supplement field operations.

From small-scale topographic base maps through larger-scale topographic maps and aerial photography to the reconnaissance-type geologic and photogeologic maps, each step is progressively important and interdependent as are the bricks in a sound wall. The use of modern techniques in aerial photography, geophysics, gravimetry, geomagnetism, electromagnetism, radio-activity, paleontology and laboratory science has helped the geologist collect more complete knowledge more quickly.

Exchange of information of the mineral exploration techniques that have been developed can be efficiently done through the medium of existing international organizations and training centres, like the Pan American Training Center for the Evaluation of Natural Resources, located in Brazil. It is recommended that increased attention be paid by PAIGH to surveys on basic resources.

Recommendations

1. That systematic geologic mapping and mineral exploration be planned for ten-year periods;
2. That such plans should provide for progressive steps as outlined above;
3. That full use be made of available new techniques;
4. That national organizations for geologic investigations be created where they do not at present exist;
5. That provision be made for research in techniques, new uses for available minerals and improved methods for extraction of minerals from ore;
6. That adequate training be provided where needed;
7. That complete international exchange of information on techniques be encouraged;
8. That existing technical assistance programmes be expanded;
9. That the Commission on Cartography, PAIGH, guide and assist the States in their minerals exploration work and that PAIGH create a Committee on Geology, and committees for work in other basic resource fields.

SOILS

The introduction to the report of the Working Group on Soils emphasizes the importance of knowledge of resources in general and of soils in particular. The modern soil survey showing the location of different kinds of soils can be used for predictions on crop success, suitability of new lands for development, determinations of erosion hazards or methods of reclamation of lands already damaged by erosion, foundations for land reform and equitable taxation and source data valuable for proposed engineering projects.

The objectives of soils surveys are directed toward the making of predictions that will clarify the possible management practices and their effects. The soil survey is compiled as both map and supporting text, presenting a combination of the results of research and agricultural

experience on the adaptabilities of crop varieties and effects of soil management. The principal uses of soil maps are:

1. Application of proved methods and new discoveries in soils by land users and agricultural advisers;
2. Planning of agricultural research;
3. Classification and zoning of rural lands;
4. Land appraisal;
5. Guides for farm buyers;
6. Planning of engineering works;
7. Reclamation planning;
8. Determination of potential distribution and adaptability of crops and agricultural methods;
9. Correlation of soil conditions among countries;
10. Correlation of soil conditions with fertilizer requirements.

The kinds of soil maps vary according to the need for information and the time available. The *schematic* soil map is usually very small-scale, showing only major soil differences, and is based on general scientific knowledge of an area, supplemented by widely spaced soil observations. *Reconnaissance* soil maps are made at intermediate scales to show associations of kinds of soil and are based on soil observations made on more closely spaced traverses (a few kilometres). In reconnaissance mapping, soil boundaries are plotted only at traverse intersections. *Detailed soil surveys* are made at scales of 1:10,000 to 1:20,000 with map units of defined kinds of soil and with completely plotted soil boundaries.

The report describes the steps to be taken in making a soil survey as identification of soils, location of soil boundaries and collection of data for interpretation. The identification treats of natural soil types divided into phases significant to soil use. After boundaries are identified they are drawn on accurate base maps or aerial photographs. If distribution of soil types is extremely intricate, the types and phases are grouped into mapping units called complexes. Data on many different properties of the soil types are collected in both field and laboratory to clarify the relationship of the soil to its environment, to other soils and to possible uses.

Soils may be grouped according to either observed or inferred characteristics, to productivity ratings and yield estimated, to special groupings relevant to economic development and according to normally associated combinations of soil types.

Emphasis is placed on the need for conducting the basic soil survey as a basically technical and scientific activity and then interpreting the survey in the light of existing economic conditions. In this way, interpretations may be revised as economic conditions or agricultural techniques change, but the basic survey remains valid.

A progressive standard national soil survey, oriented to the needs of each country, is urged for the full economic development of the Latin American countries. The steps in areas where there is little knowledge about the soils are: (1) preparation of general or schematic soil map; (2) detailed mapping in sample areas; (3) interpretation of initial data; (4) revision of the general soil map; (5) detailed mapping, and (6) publication. These steps are designed to be of maximum advantage if executed progressively.

The importance of well-trained soil scientists was stressed as well as the need for international co-operation in

establishing a consistent scheme of soil definition and nomenclature.

Recommendations

1. That national long-range plans be developed for making soil surveys tailored to the needs;
2. That the PAIGH Commission on Cartography create a permanent Committee on Soils and similar committees in other fields of resource surveys;
3. That PAIGH encourage development in all American countries of organizations capable of planning and executing soil survey programmes;
4. That PAIGH encourage technical assistance programmes for equipping and training soil survey organizations;
5. That international co-operation be undertaken for improving classification and correlation of soils;
6. That the Committee on Soils be made up of members actively working in soil classification;
7. That PAIGH encourage establishment of a more adequate training centre for soils surveys and classification;
8. That PAIGH encourage technical assistance programmes for sending Latin Americans to other countries for graduate training in soils;
9. That PAIGH encourage aerial photography coverage of Latin America as an aid to all resource development programmes.

HYDROLOGY

Of all the natural resources, "water is of fundamental importance in the economy of any nation, and, in fact, its availability is essential to the continuous occupancy of any land area on the globe". Water is generally an ever-changing resource, making it necessary to make continuous evaluation, with respect to climatic and physical factors and human use that affect its natural behaviour. The extent to which hydrologic investigations are carried on in a nation is a measure of that nation's wise preparation for further economic and social advancement.

Water resources are generally classified into two types—surface water and ground water. *Surface water*, available in streams and lakes, is the most readily available for man's needs, but because of its mobility it requires control and regulation by engineering structures, such as dams, levees, reservoirs, canals, aqueducts and pipelines, so that water will be where it is needed when the need arises. *Ground water* is water in the saturated portion of the earth's crust that sustains springs and is tapped by wells. It is widely present in many regions but because it must be observed and measured indirectly it is not as well understood as is surface water. Ground water is useful for water supplies in rural areas and in arid or semi-arid regions.

In hydrologic investigations of an areal nature, an adequate topographic base map is essential for plotting hydrologic data. Maps of 1:250,000 scale or smaller are commonly used for administrative planning and for regional or river basin investigations. Detailed field investigations are plotted on topographic base maps at scales of 1:5,000 to 1:50,000. Geologic maps are useful for ground water investigations, and aerial photography is highly desirable for most areal hydrologic investigations. The investigation itself is founded on continuing basic observations of such parameters as precipitation, tem-

perature, humidity, evaporation, transpiration, infiltration, soil moisture, stream flow and suspended sediment load, tides in estuarine rivers, lake and reservoir storage, snow and ice storage, and the recharge and discharge balance in ground water reservoirs. In order for these parameters to be significant they must be observed over long periods of time. Brief descriptions are given of the equipment and methods used for making these measurements.

The science of hydrology is concerned with the effects of the interrelation between climate, topography, vegetation, geology and soils on the natural regimen of water and the effects of human activities on the water balance. Maps showing the results of hydrologic investigations are prepared, often accompanied by an interpretative report, covering civil divisions, economic subdivisions, major river basins or hydrologic regions. These maps and reports provide essential information for broad water resources planning and management. Hydrologic maps may be divided into four general types, as follows:

1. Maps showing hydrologic features and water availability;
2. Maps relating hydrologic and geologic features;
3. Maps showing hydrologic parameters;
4. Maps showing chemical hydrologic features and relationships.

In addition to the above, the general features of water resources availability or development may be shown on simplified maps for administrative uses, or general information.

The report stresses the extreme need for long-range planning by government-sponsored agencies to protect national interest in the conservation, management and development of water resources. Long-range plans should outline objectives and proposed work for an optimum period of ten years or longer. Research is urged in basic techniques of data collection, as well as synthesis and interpretation of such data. A national water policy for water resources investigations in development and management is a necessity.

Following is the generally desirable sequence of activities for undertaking hydrologic investigations:

1. Collect, tabulate and compile existing hydrologic data from public and private sources;
2. As appropriate, obtain accurate topographic maps, geologic maps, aerial photography;
3. Establish systematic, long-term programmes of basic data collection, adequately covered in space and time;
4. Establish hydrologic laboratories for research and measurement on chemical and physical properties of water and behaviour of water;
5. Perform scientific analysis and synthesis of hydrologic data for preparation of interpretative technical reports and maps and publish these reports.

The value of international co-operation is emphasized in the exchange of information on the hydrology of river basins and hydrologic regions and on techniques and methods used in water resources investigations. The work of the International Cooperation Administration was cited as well as that of the Pan American Training Center for the Evaluation of Natural Water Resources (Brazil).

The Working Group made eleven recommendations, brief statements of which follow (more complete details may be gained from the report):

1. That provision be made for continuing research into methods for water resources investigations and for discovery of basic principles of the behaviour of water in relation to its environment;
2. That adequate training be provided in the specialized field of hydrology and related sciences;
3. That organizations for water resources investigations be created and provided with adequate continuing funds for performance of their prescribed functions;
4. That national long-range plans covering an optimum period of approximately ten years be developed for systematic hydrologic investigations and mapping and that such plans be used for annual programming for these activities;
5. That national long-range plans provide for the sequential steps described above;
6. That full use be made of all new as well as established techniques for water resources investigations;
7. That a national policy for water resources be promulgated;
8. That information on new techniques in field and laboratory methods relating to water resources investigations be fully exchanged among the American States;
9. That technical assistance programmes in the American States be expanded between those nations which have need for aid in the field of water resources investigations and development;
10. That in selected universities in the American States intensive and advanced courses in hydrology should be offered at regular intervals to qualified professionals of the Member States;
11. That the Commission on Cartography of the PAIGH assist and guide the American States in their water resources work and their work in other fields of natural resources surveys and that for this purpose the Commission create a Committee on Hydrology and similar committees in other natural resources fields. This having been done, it is believed that the name of the Commission should be changed to one more representative of all its activities. Therefore, it is suggested that the name, Commission on Cartography and Natural Resources, might be appropriate.

(b) Small-scale base maps (scales 1:250,000 to 1:5,000,000) for use in preparing topical maps

PROSPECTIVE CONSIDERATIONS ON SMALLER SCALES¹

Technical paper by Karl-Heinz Meine

The possibilities of creating other world scales smaller than 1:1,000,000 have repeatedly been taken into consideration. Professor Salischev of the Union of Soviet Socialist Republics, held, in 1957, that, as science advances, it would be feasible to give a reply to the question of publishing another series of world maps, for example, land use maps, at the uniform scale 1:5,000,000 as continental maps.

We dare say that this would merely be a very useful general map of very small scale. To prove this, the map,

¹ The original text of this paper, submitted by the Federal Republic of Germany, appeared as document E/CONF 36/L 71.

Major Land Uses in the United States at 1:5,000,000, may be cited, among others. This map is excellent from the cartographic point of view and was published in 1959 in the report *Land Use and its Patterns in the United States*.

In addition to this, I wish to recommend a new world series at the scale of 1:2,000,000, which would be a valuable supplement to the new International Map of the World on the Millionth Scale and, above all, together with maps at 1:5,000,000, a good aid for geographical regions.

Discussions on the scales 1:2,000,000 and 1:5,000,000 may be left open for further consideration during the next few years.

SOME TYPICAL EXAMPLES OF
SMALL-SCALE BASE MAPS (1:250,000-1:12,000,000) FOR SPECIAL PURPOSE MAPPING¹

Prepared by the Map Information Office of the United States Geological Survey

Issuing agency	Title of map	Scale	Base map source	Projection	Remarks
United States Geological Survey (USGS)	Geodetic control diagram (Alturas)	1:250,000	Army Map Service (AMS)	Transverse Mercator	Diagram shows control established by both the United States Coast and Geodetic Survey (USC & GS) and USGS
US Department of Commerce, Bureau of Public Roads	The National System of Interstate and Defense Highways	1:2,500,000	USGS provisional base	Albers Equal Area	Show the Federal-aid Primary Highway System and the US Numbered Highway System
USGS	Oil and Gas Fields of the United States	1:2,500,000	USGS	—do—	
USC & GS	Isogonic Chart of the United States	1:5,000,000	USC & GS	Lambert Conformal Conic	Similar charts of Alaska and Hawaii on reverse side. (Shows lines of equal magnetic and equal change)
USC & GS	Index of Geodetic Control Diagrams	1:5,000,000	USGS	Albers Equal Area	
USC & GS	Status of Horizontal Control—United States	1:5,000,000	USGS	—do—	
USC & GS	Status of Vertical Control—United States	1:5,000,000	USGS	—do—	
US Department of Agriculture, Agriculture Research Service	Major Land Uses in the United States	1:5,000,000	USGS	—do—	A sheet of the National Atlas of the United States
USGS	Coal Fields of the United States, Sheets 1 and 2	1:5,000,000	USGS	—do—	Sheet 1, 48 contiguous states; Sheet 2, Alaska, with text and diagrams
USGS	Physical Divisions of the United States	1:7,000,000	USGS	Polyconic	With text. This is also used in the "Index to a set of One Hundred Topographic Maps"

¹ The original text of this paper, submitted by the United States of America, appeared as document E/CONF 36/L.54.

Some typical examples of small-scale base maps (1:250,000-1:12,000,000) for special purpose mapping — (continued)

<i>Issuing agency</i>	<i>Title of map</i>	<i>Scale</i>	<i>Base map source</i>	<i>Projection</i>	<i>Remarks</i>
Corps of Engineers, US Army	Division and District Boundaries for River, and Harbor, and Flood Control	1:7,000,000	USGS	Albers Equal Area	
US Weather Bureau	Standard Deviations of Monthly Average Tem- perature Degrees F	1:10,000,000	US Weather Bureau	—do—	A sheet of the National Atlas of the United States
US Weather Bureau	Mean Annual Precipita- tion in Millions of Gal- lons of Water <i>per</i> <i>capita</i>	—do—	—do—	—do—	—do—
US Weather Bureau	Mean Annual Total Pre- cipitation (in inches) by State Climatic Divisions	—do—	—do—	—do—	—do—
US Weather Bureau	Mean Daily Minimum Temperature (F°) July	—do—	—do—	—do—	(Available for each month)
US Department of Agri- culture, Agriculture Research Division	Generalized Types of Farming in the United States	—do—	USGS	—do—	A sheet of the National Atlas of the United States
Interstate Commerce Commission	Map of Standard Time Zones of the United States	—do—	—do—	—do—	—do—
US Department of Agri- culture, Soil Conserva- tion Service	Published Soil Surveys	—do—	—do—	Polyconic	—do—
USC & GS	Aeronautical Charts	1:12,000,000	USC & GS	Lambert Conformal Conic	A sheet of the National Atlas of the United States (Index of Jet Navigation Charts, Scale 1:2,000,000)
USC & GS	—do—	—do—	—do—	—do—	A sheet of the National Atlas of the United States (Index of Local Aero- nautical Charts, Scale 1:250,000)
USC & GS	—do—	—do—	—do—	—do—	A sheet of the National Atlas of the United States (Index of World Aero- nautical Charts, Scale 1:1,000,000)
USC & GS	—do—	—do—	—do—	—do—	A sheet of the National Atlas of the United States (Index of Sectional Aero- nautical Charts, Scale 1:500,000)
USC & GS	Nautical Charts	—do—	—do—	—do—	A sheet of the National Atlas of the United States (Index of Sailing Charts, Scales 1:600,000 and smaller)
USC & GS	Nautical Charts	1:12,000,000	USC & GS	Lambert Conformal Conic	A sheet of the National Atlas of the United States (Index of General Charts, Scales 1:100,000- 1:600,000)

Some typical examples of small-scale base maps (1:250,000–1:12,000,000) for special purpose mapping — (continued)

<i>Issuing agency</i>	<i>Title of map</i>	<i>Scale</i>	<i>Base map source</i>	<i>Projection</i>	<i>Remarks</i>
USC & GS	Nautical Charts	1:12,000,000	USC & GS	Lambert Conformal Conic	A sheet of the National Atlas of the United States (Index of Coast Charts, Scales 1:50,000–1:100,000)
USC & GS	—do.—	—do.—	—do.—	—do.—	A sheet of the National Atlas of the United States (Index of Harbor Charts, Scales 1:50,000 and larger)
USC & GS	—do.—	—do.—	—do.—	—do.—	A sheet of the National Atlas of the United States (Index of Intra-coastal Waterway Charts)
USGS	Status of Topographic mapping	1:10,000,000	USGS	Albers Equal Area	
USGS	Status of Topographic Mapping in the United States—Map 1	1:5,000,000	USGS	—do—	

(c) Projection system, conventional signs, legends and romanization for topical maps

CONVENTIONAL SIGNS, LEGENDS AND ROMANIZATION¹

Background paper submitted by Thailand

CONVENTIONAL SIGNS AND LEGENDS

ROMANIZATION

Most of the specifications for the International Map of the World on the scale 1:1,000,000 have now been established. It is probably best to follow the standard conventional signs and legends used on this map, with additional conventional signs and legends for a topical map designed in accordance with the scale of the map, as mentioned in the sub-item of the provisional agenda entitled "Types and scales of topical maps".

For topical maps, the romanization system should be either the English or the French system. Geographical names should be transliterated according to their pronunciation and the names of geographical features should be translated into either English or French, for example, Ao Thai should be Gulf of Thailand and Ko Sichang, Sichang Island.

Since these are small-scale maps which will later be compiled into a regional map, the names of their geographical features should be suitable for international use.

¹ The original text of this paper appeared as document E/CONF. 36/L.16.

REGIONAL PROJECTION SYSTEM FOR TOPICAL MAPS¹

Background paper submitted by Thailand

REGIONAL CONCEPTS FOR TOPICAL MAPPING

It is clear that various kinds of topical maps are needed for geographic planning and development. Before embarking on the compilation of topical maps, it is best to recognize the geographic regions for which the maps are to be made. Knowing the extent and the shape of the regions, the regional projection system can be so selected as to obtain the best cartographic representation. It is pointless to select a projection arbitrarily for a region to be mapped when large areas of water and land not directly related to the interested regions are included. When the

maps are reproduced on a larger scale, the unimportant areas are also enlarged. The result is a waste of space as well as a waste of money.

USUAL ORIENTATION

Generally, the conservative methods of orientation are strictly followed in compiling topical maps, i.e., latitude and longitude are centrally and symmetrically oriented; the North Pole has to be on the top margin of the map sheet; the maps must preserve the shape, the area and the direction. These rules are followed even though much of the area of the map sheet carries no detail on related features.

¹ The original text of this paper appeared as document E/CONF. 36/L. 21.

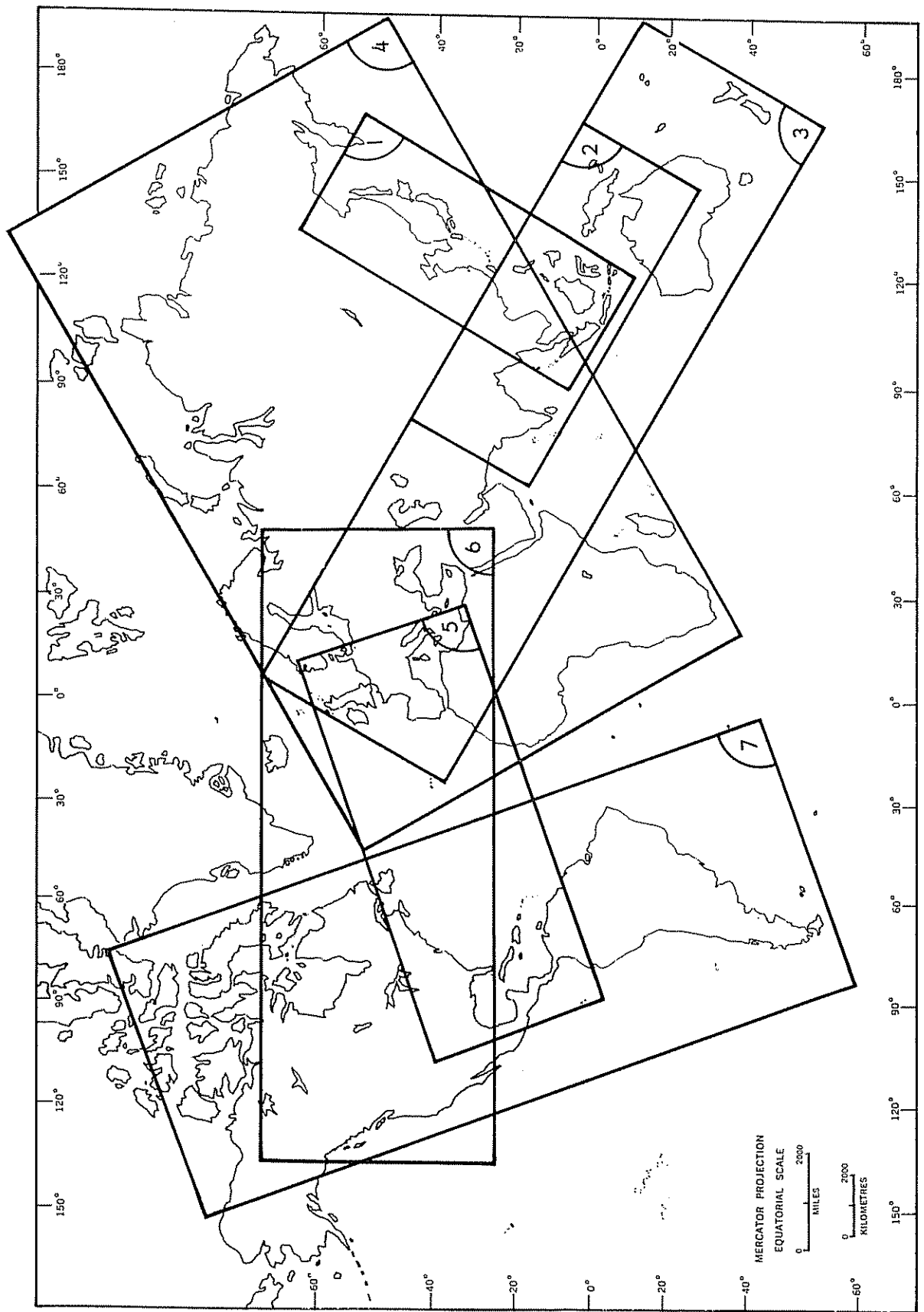

Figure 102. Outline map of proposed interrelated regions having similar projections

INTERRELATED REGIONS

In geography as well as in cartography, priority in carrying out a mapping project is always given to densely populated regions. With this principle in mind we can see that the southern rim of Eurasia, including the Philippines and the Indonesian islands, is densely populated. This portion of the world is most active economically and culturally. The next densely populated portion of the world is the eastern part of North America. In compiling the topical maps, therefore, consideration should first be given to the said portions of the world, which may be divided into related regions as follows:

1. East Asia;
2. Tropical monsoon area of south Asia;
3. Eurasian axis;
4. Afro-Asian land mass;
5. Atlantic basin;
6. Western world;
7. American continents;
8. Polar regions.

Definitions of the interrelated regions and suggested projection systems

1. *East Asia*

This region comprises the south-eastern rim of Eurasia, i.e., Japan, the east coast of China, Indonesia and the Indo-Chinese peninsula. This is one of the most populated regions of the world, requiring accurate and up-to-date topical maps for planning and development. The region has a common oriental culture. See No. 1 on the index map in figure 102. The suggested projection is the Transverse Mercator with the central axis of the projection lying approximately in the direction of Malaya and Japan. Other transverse projections may be attempted if they are conformal for the purpose of geographic reductions.

2. *Tropical monsoon area of south Asia*

This region comprises India, Pakistan, Burma, Thailand, Laos, Cambodia, Viet-Nam, Malaya and Indonesia. The region lies in the world's heaviest rainfall belt; it is also densely populated and is influenced by Indian culture. See No. 2 on the index map. The projection system suggested is the Transverse Mercator with the axis of the projection lying along West Pakistan through Thailand and New Guinea. Other transverse projections which are conformal may be attempted for particular geographic reduction.

3. *Eurasian axis*

This region includes most of western Europe and the Mediterranean area, India, Malaya, Indonesia, Australia and New Zealand. This is a long axis of the world's most populated region, with the exception of Australia and New Zealand. The importance of this region is the trade belt between Europe and Asia, which continues onward to Australia and New Zealand. Ocean, air and land traffic is also the heaviest in the world. See No. 3 on the index map. The projection system suggested is the Transverse Mercator with the axis of the projection lying approximately along the United Kingdom, India and New Zealand. The Transverse Lambert Conformal Conic projection may be attempted with the projection lying approximately in the same direction as indicated for the Transverse Mercator.

4. *Afro-Asian land mass*

This is essentially a map of Africa, Europe and Asia. The upper left-hand corner of the map will be somewhere in the North Atlantic, the lower left-hand corner will be close to the Cape of Good Hope, the upper right-hand corner somewhere close to the Bering Strait, and the lower right-hand corner near the island of New Guinea. See No. 4 on the index map; actually the indicated corners are not well represented, but they can be visualized on any model of the globe. The Transverse Mercator projection is suggested with the axis of projection lying approximately along the direction of Cairo-Tokyo. Other transverse conformal or equal area projections may be tried.

5. *Atlantic basin*

This is the map of the region subjected to western cultural influence. It is one of the world's most outstanding trade belts. Furthermore, it plays a very important part in the economic and political life of the world, although the land areas are separated by the Atlantic Ocean. See No. 5 on the index map. It is suggested that the Transverse Mercator projection be used, with the axis of projection lying approximately along the direction of New York-London. Other transverse conformal projections may also be tried.

6. *Western world*

This region comprises the land areas on each side of the Atlantic basin and covers a much greater area than 5. The topical maps for this region would indicate the historical and cultural influence of western Europe on the newly settled areas of North America and the present economic and cultural influences of the North American continent on western Europe. See No. 6 on the index map. The suggested projection is the Transverse Mercator with the axis of projection lying approximately along the direction of London-Chicago. Other transverse conformal projections may also be tried.

7. *American continents*

This region covers North and South America and includes Greenland. It is essentially a New World region, which can be considered as a unit apart from the rest of the world. See No. 7 on the index map. Only the Transverse Mercator projection can be suggested here for the whole length of the two continents. The axis of the projection would lie approximately along New York-Rio de Janeiro.

It should be observed that when air routes are considered, the topical map regions No. 1 and No. 7 can be planned in such a way that axes of projections for both regions are on the same line. This emphasizes a direct air route from Malaya or Thailand via Japan and the North Pole to California and Argentina. The same consideration can also be applied to the sea routes.

Advantages of the suggested projection systems

The following are some of the advantages to be obtained from the suggested projection systems of topical maps of the indicated regions:

1. Scales of the maps may be made larger without showing unnecessary water areas;
2. Large areas of the regions are covered without unnecessarily wasting paper by showing void areas with no topical information;

3. Greater conformity may be attained for a limited extent of the mapping area;

4. Emphasis can be laid solely on the populated regions where people obtain the necessary resources and utilize the land for their existence.

CONCLUSION

Beside all of the standard projections normally used in the geographical atlas for basic understanding, the regions discussed above should be considered for advanced topical mapping with transverse projections. The aim of these

suggestions is to obtain well-balanced and well-distributed topical features in a given region. It is therefore hoped that if a regional economic atlas could be made feasible, these suggested systems of regional projection would be experimented with.

If the technical committee wishes to adopt a resolution on this suggestion, it should request the experts from the member countries to start working on the projection systems in which they are interested, and propose that the results of their work be presented at the next conference for further examination and approval.

(d) Regional atlas

ESTABLISHMENT OF A CENTRAL ORGANIZATION FOR COMPILING AND PRINTING A REGIONAL ECONOMIC ATLAS FOR ASIA¹

Proposal submitted by Thailand

IMPORTANCE

Economic maps are indispensable tools for economic planning and development, and many countries in the Asian region urgently need such maps. Only some of these countries, however, have available economic maps on a small scale. No country, however rich in natural resources, can be independent in its economic development, since there are always certain regional geographic patterns which must be studied before deciding upon a development project in order to take into account their potentiality. Usually, the geographic patterns of a region do not conform to its political divisions, and a consideration of economic phenomena from the regional point of view cannot be neglected in an efficient approach to the problem. It is therefore necessary to compile a regional economic atlas for Asia in order to provide a sound basis for adequate planning. A number of resolutions dealing with cartographic techniques have been adopted, but many of them have not been tested in practical application. The undertaking of this regional atlas would offer an opportunity to test these resolutions. The maps so produced would also serve as a prototype for other topical maps yet to come, and would render valuable service to students and scholars of geography throughout the world.

PROPOSED PROJECT

The first project should not be too comprehensive. It should preferably be limited to a small number of maps the compilation of which should be completed in the interval between two consecutive regional cartographic conferences. A central place should be selected, at which the representatives of the countries of Asia as well as of countries outside this continent would meet to classify the source materials brought along with them for the planning of the atlas, and to undertake the compilation for printing. The final drawing would have to be approved by a technical committee before publication.

FINANCIAL CONSIDERATION

The countries interested in the project should set up certain revolving funds and send their representatives or

scholars to work at the centre. The sales of the atlas would be used to meet the expenses incurred in its production. The management of this fund should be entrusted to the United Nations.

PUBLICATION AND DISTRIBUTION

The proposed central organization should not itself endeavour to undertake the publishing and distribution of the atlas, since nowadays there are a number of adequate cartographic publishing companies which may be interested in contracting for the work. It is advisable that the organization, with the help of the United Nations Cartographic Section, prepare a preliminary draft of the atlas for the contracting company before making a final decision on the project. Brief research is therefore necessary, and it should be carried out by the representatives of the interested countries within a short period, so that only small expenses would be incurred.

LOCATION OF THE CENTRE

It is not feasible at this time to fix the site for the centre until (a) the project is approved by the Conference, and (b) the names of the interested countries are known. The centre need not be in an Asian country if conveniences and facilities are found in a country outside this continent which agrees to act as host.

PROPOSALS FOR RECOMMENDATIONS

The following is an outline of the proposals for recommendations at the preliminary stage.

(a) Interested countries are requested to provide the Third Regional Conference at Bangkok with a list of the source materials which would be made available for the compilation of the proposed regional economic atlas. This list will be helpful in evaluating the feasibility of the project, and such a list should be requested from every country in Asia, whether or not that country intends to send a representative to work on the project.

(b) The cartographic publishing companies may participate as observers, so that they may be able to study the possibility of contracting for the work.

(c) Facilities within a country for the compilation of the atlas, such as office space, drafting equipment and

¹ The original text of this paper appeared as document E/CONF. 36/L.9 and Add I.

supplies and housing for representatives should be studied. (It should be kept in mind that the work of compilation is limited to the final manuscript of the atlas, while fair drawing for reproduction must be done by contracting cartographic companies.) Knowledge of the available facilities is needed in order to list the countries in order of priority, so that a request may be made to the selected host country for setting up the organizational centre.

(d) Since it may not be possible for any country to decide to send a representative to work on the project unless the resolution on the project has been adopted, the representatives at the Conference in Bangkok should try to reach conclusions and to draft a programme for the atlas, so that their report can be submitted to Governments at an early date.

(e) When the decision has been made and the plan of the atlas prepared, the United Nations Cartographic Section should be requested to assist in finding a contractor for the publication and distribution of the atlas.

(f) The timing of the discussion on the location of the centre, and of the compilation work will be arranged by the fourth conference, in order to accord with the proposed specifications for resources inventory maps.

(g) If the organizational centre is established, it should also be responsible for the compilation of the regional stereographic and anaglyphic atlas.

ANNEX

A. Proposed check list of source materials

1. Basic mapping status of interested countries

- (1) Topographic maps
- (2) Hydrographic maps
- (3) Photographic coverage

2. Climatic maps and diagrams

- (1) Temperature (monthly)
- (2) Pressure (monthly)
- (3) Wind (monthly)
- (4) Rain (monthly and annual)
- (5) Climatic regions
- (6) Cloudiness
- (7) Storms and storm tracks
- (8) Sea and ocean currents
- (9) Earthquakes
- (10) Other subjects

3. Natural vegetation and forest resources

- (1) Natural forest types:
 - Trees
 - Grass
 - Shrubs
 - Other
- (2) Economic forest products
- (3) Other suggestions

4. Soils

- (1) Soil regions
- (2) Soil diagram (vertical)
- (3) Soil erosion
- (4) Soil sedimentation
- (5) Other suggestions

5. Geology

- (1) Distribution of surface rocks
- (2) Geologic provinces
- (3) Structural diagram

- (4) Volcanoes
- (5) Other suggestions

6. Agriculture

- (1) Agricultural regions of production
- (2) Animals on farms
- (3) Pests
- (4) Insects
- (5) Diseases
- (6) Other suggestions

7. Industrial centres

- (1) Textiles
- (2) Metals
- (3) Machinery
- (4) Food processing
- (5) Chemicals and non-metallic minerals
- (6) Ceramics
- (7) Construction materials
- (8) Oil refineries
- (9) Publishing
- (10) Handicrafts
- (11) Other suggestions

8. Population

- (1) Distribution
- (2) Density
- (3) Migration
- (4) Literacy
- (5) Death rate
- (6) Birth rate
- (7) Employment
- (8) International linguistic regions
- (9) Other suggestions

9. Communication

- (1) Communication lines
- (2) Radio communication
- (3) Other suggestions

10. Transportation

- (1) Rail connexions
- (2) Road connexions
- (3) Air Transportation
- (4) Inland waterways
- (5) Coastal waterways
- (6) Sea and ocean routes
- (7) Other suggestions

11. Minerals

- (1) General geographic distribution
- (2) Diagrams or statistics showing:
 - (a) Potentiality
 - (b) Production rate
- (3) Other suggestions

12. Water resources

- (1) Drainage regions and river charge
- (2) Ground water resources
- (3) Springs and mineral waters
- (4) Irrigation projects
- (5) Other suggestions

13. Power resources

- (1) Water power (potential and developed)
- (2) Petroleum and natural gas
- (3) Coal and lignite
- (4) Electricity
- (5) Other suggestions

14. Animal resources

- (1) Land animals
- (2) Birds (permanent habitation and seasonal migration)
- (3) Maritime or coastal fishing grounds

15. *Tourist resources*
 - (1) Resorts and parks
 - (2) Historical sites
 - (3) Other suggestions
16. *Stereoscopic and anaglyphic atlas*
 - (1) Photographs of typical topographic features of the country
 - (2) Maps of the areas appearing in the photographs
 - (3) Other suggestions
17. *Other proposals*

B. Proposed agenda for the discussion

1. Presentation of the proposal
2. General discussion
3. Financial consideration
4. Publication and distribution
5. Location of the centre
6. Preliminary discussion on source materials
7. First draft of the contents of the atlas
8. Final or revised list of source materials to be collected by interested representatives for further planning and compiling
9. Setting up a correspondence centre to direct the collection of source materials between the third and fourth conferences
10. Other discussions
11. Report of the discussion and conclusion
12. Approval of the report

C. Minimum requirements for the office of the central organization for compiling and printing the regional economic atlas

1. One large office
2. Two complete drafting sets
3. Facilities for photographic and lithographic reproduction of all base maps
4. Boarding facilities for a group of four or five working representatives of interested countries. (The working representatives will take turns in working at the centre on the topics which fall within their experience)
5. Other proposals or modifications

D. Selection of the centre

Proposed criteria for selection of the site

1. Transportation from member countries of Asia
2. Presence of minimum requirements for compilation work as stated
3. Ease of contact by contracting cartographic publishing company
4. Expenses involved
5. Other considerations

List of proposed sites (arrange in order of priority)

	<i>Name of mapping agency</i>	<i>City</i>	<i>Country</i>
1.
2.
3.

COMPILATION OF A REGIONAL STEREOSCOPIC AND ANAGLYPHIC ATLAS¹

Proposal submitted by Thailand

PURPOSE

To extend the knowledge of photo-interpretation for geographic purposes, it is requested that all interested countries should pool their resources and compile a regional stereoscopic and anaglyphic atlas. The atlas will be used as a basic key for training in photo-interpretation in the different branches of geography, such as geology, geomorphology, soil science, forestry, hydrology and climatology.

PROPOSED PROJECT

The first project should not be too comprehensive: only outstanding and well-defined photographic details should be incorporated into the atlas. The interpretation of the stereoscopic pairs of photographs should be as complete as possible. The atlas should also contain maps, charts, graphs and diagrams which will explain all of the related features.

PROCEDURE

The representatives of the interested countries should meet to decide on what photo-geographic features they

should be responsible for interpreting and reporting. This is to avoid a wasteful duplication of the features to be compiled into the atlas. Each representative may first suggest lists of the features to be interpreted and then each country may select the topics which it feels able to contribute to the work. The next regional cartographic conference would be the appropriate time for presenting the reports. After enough material is gathered, publication of the atlas should present no difficulties as there are many publishing companies willing to co-operate with the project.

SUGGESTED BRANCHES OF INTERPRETATION

The following may be considered as branches required for the atlas.

1. Geology
2. Geomorphology
3. Soils
4. Forests
5. Hydrology
6. Hydrography
7. Settlement patterns

These branches may be subdivided into smaller units according to their photo-geographic features.

¹ The original text of this paper appeared as document E/CONF. 36/L.20.

AGENDA ITEM 16

Aeronautical charts

RECENT DEVELOPMENTS IN CARTOGRAPHIC METHODS AND TECHNIQUES¹

Background paper prepared by the Aeronautical Chart and Information Center, the United States Air Force and the United States Coast and Geodetic Survey

ELECTRONIC DODGING PRINTER

A continuous dodging printer for aerial photography has been adopted. The device scans the image electronically, and automatically adjusts the exposure from point to point of the image so as to stay within a pre-set range of contrast density. The result is that maximum resolution is obtained in both the highlight and shadow areas, the former being rendered darker and the latter lighter in tone than the original. Unlike manual dodging, or dodging by multiple light source, electronic dodging considers each smallest point of the image individually and adjusts the exposure accordingly. Many photographs which, because of excessive contrast, would be unusable in modern stereophotogrammetric equipment, are made usable. The equipment processes individual frames or it may be employed as a continuous strip printer.

ELASTIC IMAGE MODIFICATION IN COMPILATION

A modern adaptation of an old idea is being used in chart compilation. A source map image is reproduced on the surface of a thin rubber sheet, which is then stretched to match the scale and projection of a chart being compiled. The image thus modified is then transferred to the chart compilation. The semi-transparency of the thin rubber permits tracing and contact photo-reproduction. Expansion of the rubber sheeting is remarkably uniform, and can be closely controlled to produce fairly accurate transformations of geographic detail from one type of map projection to another. The technique finds its greatest utility in instances where drastic shape changes are necessary; it is not usually employed in normal production, where standard methods serve. The technique produces only intermediate, or working, copy and is not applied to finished, published charts.

PORTABLE PHOTOGRAPHIC CONTACT PRINTER

The need for a quick and convenient means of obtaining contact photocopies for chart compilation uses has resulted in the adoption of a portable type of printing unit. This device consists of a shallow rectangular box containing a bank of ultra-violet tube lamps under a heavy sheet of glass, and a sponge-rubber-lined lid which, when closed, presses the graphic and sensitized materials against the glass and each other in firm contact for the exposure. Various "dry process" media are employed, making it

possible to produce a large proportion of the working copy needed in chart compilation, under ordinary room lighting and at the place where it is to be utilized, without dark-room or special plumbing. With these media, a time and material saving is enjoyed in that an intermediate negative step is not required for making positive copy from a positive original. The units are placed at strategic locations throughout the compilation work areas and are operated by cartographer personnel to satisfy their own requirements as need occurs.

QUALITY CONTROLS IN PRINTING

Methods for evaluating and maintaining close control over the quality and use of printing materials, equipment and products have been devised by the Aeronautical Chart and Information Center and put into effect in its printing and camera departments. A coding system which converts the many characteristics of an acceptable printing ink into numerical values has been instituted. By this means, such features as colour, grind, consistency, specific gravity, opacity, shelf life, light fastness, drying characteristics, etc., can be precisely defined, and uniformity of product promoted. Printing itself is evaluated under general headings of colour, registration and lithographic quality, by means of sampling during the press run, using both electronic and visual inspection. Defects are assigned a numerical code which expresses them with accuracy and consistency. A "screen line determinator" has been developed to facilitate the printing of tints and half-tones. It quickly determines proper screen line and angle for a given desired result, making unnecessary the application of operator judgement or trial and error determinations. Transmission densitometer readings, rather than dot measurements, are being employed to control applications of half-tone screens. The readings provide more accurate and consistent results.

WORKING COPY IN COLOUR

The reproduction of original source maps in colour, rather than in monochrome, for use as working copy in photomosaic and chart compilation has been increasing. The coloured copy has special advantages in making easier the differentiation among map features when the original must be greatly reduced in size to match compilation scale, since feature interpretation and selection are greatly improved as compared to similarly congested monochrome copy. Reversal colour film processes are used for source map copy, and the positive transparencies thus obtained can be assembled into a panelled preliminary compilation

¹ The original text of this paper and those of the following three papers were submitted by the United States of America and appeared together as document E/CONF.36/L.55.

in the same manner as monochrome transparencies are usually assembled.

ADVANCES IN THE PHOTOMECHANICAL PREPARATION OF PHYSICAL RELIEF PORTRAYAL

Traditionally, the portrayal of pictorial physical relief on aeronautical charts (as on maps in general) has been the product of artistic interpretation, manually applied. Development activity is under way to create these effects photomechanically, to whatever extent possible. Although production application has not as yet been achieved, the investigation has revealed certain approaches which have considerable promise. Experiments with the photography of plaster and/or plastic (especially) terrain models, suitably side-lighted, show that this method is likely to produce the results desired. The photographs may possibly be used directly, or they may be used as "controls" for an improved, more positive and more uniform manual technique. Photographs of models are superior to photographs of the actual terrain for direct application, since the models can be made to contain no extraneous information other than the land forms themselves, special treatments can be introduced to augment their pictorial qualities, and the procedure is more susceptible to control in all phases. A rapid and accurate means of producing such models is required. It is believed that the "photopolymerization" method will eventually be this means.

PHOTOPOLYMERIZATION METHOD FOR CREATING PHYSICAL RELIEF MODELS

A useful development is near completion in the preparation of terrain surface models, in plastic, by a photomechanical method. This method involves the exposure of a photopolymerizing liquid to the action of light reaching it through a sequence of negatives each of which represents a level in height of the terrain which is to be reproduced in miniature. According to its depth of penetration into the liquid, as determined by the accumulation of exposures made through the succession of negatives, the light causes the liquid to set, or gel, in varying thicknesses which correspond to the elevations of the terrain. It is only necessary to have a contour system from which the elevation negatives can be prepared. The model is created in the liquid with considerable speed, and with accuracy sufficient for the purpose: that is, as a "master" for the development of true and uniform relief portrayal on aeronautical charts. The procedure is very critical; however, preliminary trials, along with modifications to equipment and techniques, have removed many initial inconsistencies. Numerous small trial models have been produced, and operations are being instituted on full-scale, chart-size models for production testing.

As suggested above, these are intended as "master" models—their use as final products is not contemplated. They will be used for the preparation of two-dimensional shaded relief portrayal on aeronautical charts, either directly by photography or in conjunction with semi-manual methods.

THE ROTOVERSER

The "Rotoverser" is an optical and mechanical device for attachment in front of the lens of the conventional copying camera, for reversing the image. In effect, it counteracts the normal reversing action of the camera lens, and provides a picture on the copy-board which is aligned in all respects like the original rather than being

reversed in alignment. The reversal is accomplished by the action of a dove prism, and there are no moving parts or adjustments in the action of the prism itself. However, the barrel in which it is mounted can be revolved, and this permits rotation of the image, for additional convenient orientation on the copy-board. Other than this, the usual vertical and lateral motions of the camera are usable in the regular fashion, to focus and orient the image.

Inasmuch as the addition of a Rotoverser to the lens system of a camera will obviate the need for the traditional contact transfer of the image from the camera film to another surface in order to obtain a properly oriented image (the camera itself delivers the final product), direct positive media, such as diazo, and electrostatic materials, can be employed. Reproduction is accelerated and made more economical.

SEQUENTIAL CAMERA TECHNIQUE FOR FREQUENTLY REVISED PUBLICATIONS

A "sequential camera" system has been adopted to accelerate the preparation and reproduction of frequently revised and reissued publications, such as flight guides and bulletins, and the specifications for aeronautical chart production. The system utilizes a "Compos-O-Line" camera—a power-operated instrument which automatically copies typewritten lines from a series of cards (one line per card) in a pre-set sequence. A film negative strip within the camera advances one "step" with each exposure, and the next card is automatically flipped into position for the next exposure. Thus, the image lines from the cards become regularly spaced successive lines of text on the film. The film is processed and cut into page-size sections, which are then used to expose lithographic printing plates.

Any desired line in the text can be revised by withdrawing its card from the "deck" and substituting another card bearing the corrected wording. Cards bearing information which does not need changing are not disturbed, although the wording of some of the adjoining cards may also need adjusting if the number of words is much increased or decreased. However, complete retyping of an entire text, or even a whole page, is obviated. The next "run" of the cards through the machine produces another film strip, into which the revised material is automatically accommodated. Catalogues, glossaries and listings of various kinds are particularly well suited to maintenance by this method.

PREPARATION OF SCRIBEGUIDES BY THE RUB-ON DIAZO METHOD

A method of printing scribeguide images on scribeguide sheets from positive originals is being used by the Coast and Geodetic Survey. This procedure has been developed through use of a rub-on diazo coating. It is more economical and furnishes a better image than the blue-line method which was previously used.

Procedure

1. Sensitize the scribesheet by hand application of diazo solution;
2. With positive and scribesheet in contact in a vacuum frame, expose to carbon arc lamps;
3. Develop by exposure to ammonia fumes.

The coating or sensitizing of the scribesheet with rub-on diazo solution can be accomplished rapidly and sheets are ready for exposure within a few minutes.

The length of exposure to arc lamps is not critical and will depend upon the intensity of the light source and the material being printed. Good results have been obtained from photographic positives, ink drawings or compilations on plastic, pencil drawings on plastic and even low-contrast continuous-tone photographic films. Negative images may also be processed if desired.

Development of exposed image is best accomplished in the development chamber of a dry-diazo processor. However, images can be developed by placing the exposed sheet above a container of ammonium hydroxide in either a tube or a cabinet.

Supplies

1. Rub-on Diazo Solution, K & E X3090 Rub-on Diazo, Keuffel and Esser Company, Hoboken, New Jersey, USA;
2. Ammonium hydroxide;
3. Scribesheet, plastic or glass

IMPROVED NEGATIVE AND SCRIBING OPAQUE

The Coast and Geodetic Survey has developed a negative opaquing paint which has excellent covering and scribing qualities. The paint is used on wet plate glass negatives, photographic film, scribesheets and uncoated plastic sheets.

Formula

- Forty fluid ounces extra heavy asphaltum;
- Eight ounces avoird. BTA lampblack;
- Eight fluid ounces redistilled turpentine.

Directions for mixing

1. Pour asphaltum into metal container;
2. Add lampblack to asphaltum by sifting it through a fine wire mesh screen;
3. Mix ingredients together with a Palo Impelator (blender) for about thirty minutes at a speed of about 1,000 r.p.m.;
4. Add redistilled turpentine to mixture and continue mixing with Palo Impelator until the temperature of the mixture has risen 15 degrees F. (The temperature must not be induced externally but should result from the milling action of the ingredients.) This blending time is approximately three hours.

Directions for using

1. The paint in this state is concentrated with good stability;
2. Take a small amount of the paint and thin it with redistilled turpentine to a useful consistency, and it is ready for application.

Supplies

1. Palo Impelator (manufactured by Palo Laboratory Supplies, Inc., 75 Ninth Avenue, New York 11, NY, USA; this is a special type of blender. A ball mill may be used with good results, though requiring a longer mixing time).
2. *Extra heavy* asphaltum (made by General Printing Ink Company, 750 Third Avenue, New York 17, NY, USA);
3. BTA lampblack (made by Monsanto Chemical Company, Inorganic Sales Office, 445 Park Avenue, New York 22, NY, USA).

PHOTOGRAMMETRIC SURVEYS FOR AERONAUTICAL CHARTING

Background paper by Captain L. W. Swanson, Chief, Photogrammetry Division, United States Coast and Geodetic Survey

One of the principal functions of the Coast and Geodetic Survey is to provide aeronautical charts for the United States and its territories, and photogrammetric surveys to supply data for this purpose have been a part of aeronautical charting activity for the past twenty years. Photogrammetric surveys are applied primarily to the location of aids to air navigation, and to the mapping and gathering of data at civil airports and along the runway approaches. This monograph is a brief summary of the history of this work and a description of present practices.

Photogrammetric surveys for aeronautical charts present an interesting story of the rapidly increasing demand for survey data brought about by the unprecedented increase in air transport, and the development and adaptation of new photogrammetric techniques to meet this demand.

Photogrammetric surveys for aeronautical charting were first undertaken in 1941 to provide base maps and other data for the publication of a new series of Instrument Approach and Landing Charts. Primary requirements were for a large-scale map of each civil airport together with a medium-scale planimetric map of a twenty-mile square around the airport, the location of aids to air navigation and determination of the positions and elevations of tall objects that were considered obstacles to air traffic. This information was needed quickly for production of the new charts and photogrammetric surveys were

the obvious answer if the charts were to be produced in time to meet aviation requirements.

The methods adopted for these first photogrammetric surveys were crude by today's standards but adequate for the immediate purpose and very satisfactory progress was made. Air photographic coverage of sorts was available for most of the United States and prints were bought from all government agencies having suitable coverage. New photography was taken in some instances but for the most part existing photography was used. A considerable amount of the photography was obtained from the Department of Agriculture which had photographed large areas at a scale of 1:20,000 with 8¼-inch cameras.

Small mobile field parties were organized to field inspect the aerial photographs, to identify existing horizontal control, to identify obstructions (tall objects in the vicinity of airports) and to determine their elevations, to determine elevations of the airfields and to obtain and field verify large-scale plans of runways, airport lighting, etc., to make magnetometer observations for magnetic declination and to observe polaris or solar azimuths. Basic spirit levelling was done to determine the airport elevation, and the elevations of outlying obstructions were determined by barometric and trigonometric levels. Present-day altimeters were not available at the start of this programme

and much of the barometric levelling (one base station method) was done with banks of aircraft altimeters arranged in a special carrying box with an electric vibrator.

Photogrammetric plotting was done by radial line methods using a special type of spider templet designed by the Bureau for this purpose. All compilation was done by graphic methods on transparent plastic sheeting.

Some 550 airports had been surveyed by these methods when, in 1944, it became evident that a regular maintenance programme would be necessary because of the frequent changes occurring at and near civil airports. In 1945, for example, new surveys were made of fifty airports and resurveys of 200 airports.

In 1945, the Civil Aeronautics Administration (now the Federal Aviation Agency) requested that the airport survey programme be expanded to obtain the additional data required for publication of a new series of airport obstruction charts that were required by both the Civil Aeronautics Administration and the airlines for administering and complying with regulations governing the gross load of aircraft in terms of runway length and gradient, obstacles in the runway approaches and other factors. The charts have subsequently been used extensively for development of air traffic procedures at airports and for the improvement of facilities. At this writing, these particular charts are called Airport Obstruction Charts (Piston). Such charts are on issue for 575 airports. Charts of some airports still remain to be published but the programme of Airport Obstruction Charts (Piston) is now a maintenance programme with a need (not yet permitted by available funds) for a revision survey of each airport on an average of once in three years.

The airport obstruction chart programme initiated a second significant phase in our photogrammetric surveys for aeronautical charts. It called for more detailed and more accurate data and these demands (as in the case of the third and fourth phases to be discussed later) have been met by developing and adapting new techniques. Photogrammetry has been changing and developing perhaps as fast as has aviation and we have been able in large part to meet new demands by using improved techniques rather than by increasing personnel.

Thus, beginning in 1945, the surveying operations were changed to provide second-order elevations of airports, to locate airports and their facilities on the national horizontal control datum, to position and determine the elevations of obstructions with greater accuracy and to extend those surveys farther out along the runway approaches. Barometric altimeters were discarded in favour of spirit and trigonometric levelling. Photographs were taken specifically for these surveys and aerotriangulation was applied to the location of features. Today, for this programme and others mentioned later, the Bureau operates a leased Aero Commander aircraft and takes photography with Wild RC8 and RC9 cameras at altitudes of from 5,000 to 23,000 feet. Most of the photography is panchromatic but experiments are beginning with colour. Field parties use Opton levels, T-2 theodolites and the tellurometer or Model 4 geodimeter. Aerotriangulation is done with stereoplanigraphs, with adjustment to ground control by electronic computer (*Coast and Geodetic Survey Technical Bulletin*, Nos. 1 and 10). Analytical aerotriangulation methods are now in production and will soon be used with RC8 or RC9 photography.

A third phase in this survey programme was initiated in 1957, when the Federal Aviation Agency requested that the Coast and Geodetic Survey determine the positions in the national horizontal control network (NA 1927 datum) of all electronic aids to air navigation.

This information was needed quickly for the programme of modernizing the federal airways, and was obtained by a combination of geodetic and photogrammetric methods. Over 700 of these aids to air navigation have been located to date and about 40 per cent of this total were located photogrammetrically.

The photogrammetric procedure included:

1. Strip aerial photography flown across the navigational aid and also across existing horizontal control on either side of the aid so as to permit aerotriangulation in accordance with the procedures of *Technical Bulletin*, No. 1;
2. Identification of the aid and the horizontal control on the aerial photographs by fast-moving, two-man field parties;
3. Aerotriangulation by stereoplanigraph or Wild A5 plotter with adjustment to ground control by electronic computer (*Technical Bulletin*, Nos. 1 and 10).

This programme called for strip photography in all parts of conterminous United States and for extremely accurate placing of flight lines. A fast, two-motored aircraft (Aero Commander) was used so that the flight crew could move quickly to take advantage of weather conditions. Reflights were extremely rare and costs per linear mile of photography, surprisingly enough, turned out to be comparable with costs of block photography, thus proving the wisdom of using a relatively fast aircraft.

No maps were drawn under this programme; the IBM read-out for the adjusted aerotriangulation provides the ground co-ordinates of all passpoints and of the aid to navigation. Photography was taken with a Wild RC5 or RC8 camera with 6-inch lens at a scale of about 1:40,000 and the number of models to an aerotriangulation strip ranged from ten to forty. The photogrammetric method proved particularly advantageous in wooded country and in areas where existing horizontal control was widely spaced, making location by ground survey methods unduly expensive.

The fourth phase in our photogrammetric surveys was brought about by the advent and rapid increase in the use of turbine-powered aircraft. For example, in 1960, 49 per cent of the total domestic air passenger-miles were flown in turbine-powered aircraft. This phase began in 1959 and will account for the greater part of our effort in 1960, 1961 and 1962.

The Airport Obstruction Charts (Piston) discussed in preceding paragraphs are still an important series but they were not designed for and do not serve turbine-powered operations. Regulations regarding the gross take-off weight of turbine-powered aircraft require that the surveys for obstacles along a defined emergency take-off flight path extend twenty miles outward from the end of the runway and determine the position and elevation of all objects projecting above a 1.2 per cent slope, beginning at the runway end. Thus, a second series of charts was started in 1959 called Airport Obstruction Charts (Turbine). These differ from Obstruction Charts (Piston) in several ways: they show less detailed information about the airport proper and are published at a smaller scale (1:36,000), but extend much farther outward along

the designated emergency take-off flight path—a distance of 100,000 feet.

The Airport Obstruction Charts (Turbine) are designed in accordance with Federal Aviation Agency specifications. They do not have the same format and design as ICAO Type A charts but meet all ICAO Type A specifications with the exception of scale.

The principal survey problems in producing the turbine charts relate to the greater areas covered and the requirements for speed in production. In this instance, as in the past, the problems are being solved by employment of new techniques. Most of the horizontal positioning of obstacles and much of the vertical work (ground elevations and elevations of well-defined obstacles) are done by aerotriangulation and stereoscopic instrument compilation. The new method of analytical aerotriangulation permits horizontal and vertical bridging of a greater number of models between ground control, both horizontal and vertical, and use of the new RC9 super-wide-angle camera will improve the base-height ratio and increase the coverage per model. A Clary electronic desk computer has recently been installed to expedite survey computations that have

not been found practicable to accumulate in sufficient volume to warrant computation on the larger IBM 650 computer.

In a further effort to expedite the production of obstacle data for turbine-powered aircraft, the publication of Airport Obstruction Charts (Turbine) will be discontinued for the year beginning 1 July 1961; these data will be published in a textual form, termed Turbine Data Sheets, thus eliminating certain drafting and reproduction phases and making it possible to get the information into the hands of users soon after the surveys are finished, in a form usable with their electronic computers.

In summary, we find that in recent years, the numerous and rather revolutionary changes in photogrammetric techniques have permitted us to keep pace with the very rapid changes in survey requirements brought about by the increasing volume and speed of air traffic. We think this will continue to be true and while these fast changing requirements and methods make life a bit hectic at times, they keep it interesting.

A sample of a Turbine Data Sheet is shown in figure 103.

EFFECT OF STRATIFIED AIRSPACE SYSTEMS ON AERONAUTICAL CHARTING

Background paper by Frank E. McClung, Aeronautical Chart Division, United States Coast and Geodetic Survey

The stratification of airspace over the United States to provide low, intermediate and high-altitude airway systems has created an unprecedented challenge in aeronautical charting. To fuse these systems into an effective and manageable whole requires the utmost ingenuity—a task which could not be accomplished without adequate charts and an orderly and timely distribution of them. Never before has aeronautical charting played such an important role in aviation.

Each stratum of airspace is portrayed on a separate and specially designed series of charts, so that the minimum number of charts is needed for flight operations in each system. The chart requirements and flight procedures for operating in each system are different, yet all series of charts must be closely co-ordinated so that penetration and transition from the three layers can be provided by traffic control and safely executed by the pilot.

As information used by pilots and controllers must be in agreement, the three series of navigational charts must be revised and issued simultaneously. The revision cycle is every four weeks, as this is the interval that has been established for changes in airspace data, and the charts are distributed in time to reach the user before the effective date of airspace changes. This creates a tremendous peak workload. In order to meet this requirement, each step in the production of the charts from compilation to mailing was carefully reviewed and new procedures were initiated whereby time could be saved and over-all efficiency improved. A strict schedule for each phase of production has been established.

Our first concern in the production cycle of charting is to ensure that all information is available in time to be applied to the next edition of the charts. Because of the large amount of information incorporated in each new edition, it is imperative that the workload be spread evenly over the period of time available. These data, obtained from many sources, must be carefully evaluated, and a

selection made of the items applicable to the charts being constructed or revised. Very close liaison is maintained between the charting agencies and those agencies from which the source material is obtained.

It might be well to mention some of the production procedures which have been adopted in order to issue charts on schedule.

1. Preliminary copies of docket containing airspace changes are furnished us by the Federal Aviation Agency normally six weeks prior to the effective date of airspace changes. This enables us to begin work immediately on some of the information to be applied to the next edition.

2. Duplicating machines are used to make multiple copies of data so that all cartographers receive the information simultaneously.

3. Drawings are made on clear plastic which allows easy registration and the review of several drawings in combination.

4. Flexible translucent plastic is used for the plotting base instead of metal-mounted drawing paper. The use of this material permits easier plotting and handling. This material can be used with the button system for registration of drawings.

5. The use of photographic positive prints of type for information received at a late date enables us to apply these changes to the charts.

6. Pre-punched film and the button register system provide accurately pre-registered negatives for reproduction processes. A standard templet keyed to the button register is used for positioning charts on printing plates and for positioning plates in press for quicker make-ready.

7. To meet the necessary deadlines, a three-shift operation (plus overtime) is scheduled in all reproduction, finishing and distribution operations.

FEDERAL AVIATION AGENCY

Obstacle data for turbine departures

ATLANTA AIRPORT

ATLANTA, GEORGIA

Data current as of February 1961

To be designated an OBSTACLE, an object must meet the following conditions: (1) it must lie within a horizontal area known as the take-off flight path area. Between runway ends and from each runway end to the airport boundary, this path extends 200 feet on both sides of the runway centerline or the centerline extended. At the first point of intersection of the extended runway centerline with the airport boundary, the flight path area expands abruptly to 300 feet on both sides of the extended runway centerline, and then flares until it reaches a total width of 4,000 feet at a distance of 13,600 feet from the airport boundary. In a flight path with no turns, the 4,000-foot width then remains constant to the end of the flight path at a distance of 100,000 feet from the runway end. If there is a turn in the flight path, the flight path area expands abruptly to 3,000 feet on both sides of the extended runway centerline at the beginning of the turn, and the 6,000-foot width continues to the end of the flight path; (2) it must penetrate a 1.2% obstacle clearance plane beginning at the runway end

A runway end is defined as the point where the runway ceases to have full width symmetrical with the centerline. Overruns, stopways, and clearways are beyond the runway end for the purpose of establishing the obstacle clearance plane.

Representative obstacles are surveyed and tabulated. In congested areas, other obstacles of lesser importance may exist. Flight path areas are clear of obstacles from last object listed to 100,000 feet.

Elevations along the first 1,000 feet of the flight path are accurate to 1.5 feet. Vertical accuracy then decreases at the rate of 1 foot per thousand along the flight path to a maximum tolerance of 21.5 feet. Vertical datum is mean sea level.

Horizontal Positions at the inner end of the flight path are accurate to 15 feet. Horizontal accuracy decreases at the rate of 2 feet per thousand along the flight path to a maximum tolerance of 55 feet.

Obstacles for take-off from Runway 15-33

OBSTACLES FOR TAKE-OFF FROM RUNWAY 33

Runway end 15 to airport boundary—1,450 feet

Obstacle	Distance from Runway End 15 along CL Flight Path	Distance off CL Flight Path	Height above Runway End 15 (elevation 1,004)
Obst. Ltd. ILS-LO	590	0	11
Pole	2,590	280 L	59
Tree	2,820	0	108
Tree	3,380	210 R	123
Pole on Building	4,160	160 L	115
Tree	5,560	590 L	119
Tree	5,900	540 L	134

OBSTACLES FOR TAKE-OFF FROM RUNWAY 15

Runway end 33 to airport boundary—3,350 feet

No obstacles.

Obstacles for take-off from Runway 9-27

OBSTACLES FOR TAKE-OFF FROM RUNWAY 27

Runway end 9 to airport boundary—3,430 feet

Obstacle	Distance from Runway End 9 along CL Flight Path	Distance off CL Flight Path	Height above Runway End 9 (elevation 1,024)
Approach Lt.	90	0	2
Approach Lt.	490	0	6
Tree	3,610	210 R	97
Tree	4,270	220 L	80

OBSTACLES FOR TAKE-OFF FROM RUNWAY 9

Runway end 27 to airport boundary—940 feet

Obstacle	Distance from Runway End 27 along CL Flight Path	Distance off CL Flight Path	Height above Runway End 27 (elevation 986)
Obst. Ltd. ILS-LO	400	0	9
Tree	1,240	260 R	38
Tree	1,600	270 L	33
Tree	5,900	80	74
Tree	6,800	440 R	90

R or L—right or left of flight path centerline when departing from runway end

Prepared and distributed by U.S. Department of Commerce, Coast and Geodetic Survey

Figure 103. Example of Turbine Data Sheet issued by the United States Federal Aviation Agency

AREA CHARTS

Undoubtedly the most complex problem for the pilot and traffic control is the transitioning of flights in and out of the terminal areas. The safe and orderly flow of air traffic in the terminal areas requires that the pilot have the transitional information available in the cockpit without recourse to the enroute chart for each stratum.

The area charts, which originally portrayed only low-altitude data, are being expanded and modified to provide intermediate and high-altitude transitional arrival and departure data. This programme is in the experimental stage, but prototype charts have been issued for operational evaluation. These charts are revised and issued with the enroute navigational charts.

STANDARD INSTRUMENT DEPARTURES

A further development is the establishment of standard instrument departures (SIDS) for high-density terminals. These SIDS will be identified by code words, and the pilot and controller will only use this code in requesting or issuing a clearance. The detailed description of each SID will be shown in both graphic and narrative form on the Area Departure Charts. This will provide positive identification of the clearance and make a marked contribution to safety by simplifying pilot/controller co-ordination at a critical time when many cockpit functions are being performed in rapid sequence. This will also eliminate lengthy radio conversations and possible errors in copying complicated departure instructions.

The first SIDS established for civil aircraft were recently implemented at New York International (Idlewild) Airport.

CONTROLLER CHARTS

At the present time, air traffic controllers are using either charts designed for in-flight use or locally designed charts tailored to meet individual requirements. There has been no uniformity or standardization of format or content. With implementation of the three-layer airway structure, the air traffic controller, in many cases, is controlling traffic on both the low and intermediate airway system. To accomplish this task effectively, the controller requires a pictorial display combining all three route systems. In terminal areas particularly, aircraft are transitioning in and out of all airway structures, and the controller must

be able to visualize his traffic with reference to all three airway systems.

A series of charts has been designed at a constant scale of 1:500,000, so that they can be matched to cover the area required by each ARTC centre. A prototype has been issued for field evaluation. The low, intermediate and high-altitude systems are shown in combination and the information shown is that which is specifically required for controller purposes. These charts must be closely co-ordinated with the navigational charts and issued concurrently so that there will be uniform interpretation by controller and pilot. Uniform treatment of charts for all areas will provide for better co-ordination between ARTC centres and result in more efficient operations.

CEILINGS AND FLOORS ON AIRSPACE

Another programme has been initiated which perhaps should be mentioned in relation to stratified airspace. This involves the establishment of variable ceilings and floors on controlled airspace to replace the normal floor of 700 feet above the surface. The purpose is to provide additional uncontrolled airspace for the VFR pilot. The effect of this programme on charting will be tremendous as these floors and ceilings must be shown on charts used by VFR operations, and if the benefits are to be fully realized, they must be revised concurrently with airspace changes. This could entail the revision of these charts every four weeks effective with scheduled airspace change dates. The magnitude of this programme is apparent when one realizes that charts used for VFR operations are printed in eight or more colours.

CONCLUSION

The stratification of airspace is just another phase in the evolution and spectacular growth of aviation to which we have now become accustomed.

No single phase of aviation progresses alone, and it should be apparent that concurrent with development and expansion of air operations, there should be a progressive aeronautical charting programme. This should allow for a continuing programme of testing and development with sufficient funds and flexibility to respond immediately to user requirements as they arise. In planning for the future, it should be remembered that the only consistent trend among prophets of aviation development is that they have always underestimated the rate of growth.

CARTOGRAPHIC DEVELOPMENT AT SCALE 1:1,000,000

Background paper prepared by the United States Federal Aviation Agency

The World Aeronautical Chart (WAC) has been used for many years as the standard 1:1,000,000-scale aeronautical chart. It was adopted by the International Civil Aviation Organization (ICAO) in 1949, and since that time many nations have contributed to its refinement and standardization, and to its production and maintenance.

The dynamic increase in aviation throughout the world and the increased speed and range of aircraft have emphasized the need for continuing study and improvement of aeronautical charts at scale 1:1,000,000. Unlike land maps, which are used under stable conditions, the aeronautical chart must provide the user with ease of position

fixing at wide ranges of speed and altitude and many different geographic environments.

The United States is at present reviewing the operational requirements for 1:1,000,000-scale aeronautical charts. The greatly increased system for air traffic control has brought about limitations on airspace available for aircraft flying under visual flight rules. This, coupled with the fact that the present aeronautical charts are based on the design of some years ago, makes it necessary to improve our present 1:1,000,000 chart to meet current operational needs.

One of the cartographic developments to be considered

for its applicability to present-day requirements is the United States Air Force Operational Navigation Chart (ONC). In the USAF development of its 1:1,000,000-scale ONC, extensive studies were carried out by cartographers working directly with aircraft pilots and air navigators to determine the best manner of depicting terrain and cultural features to meet USAF requirements. The ONC is an excellent example of cartographic development to meet these requirements, and has a number of features which deserve to be considered for incorporation into a standard 1:1,000,000-scale aeronautical chart.

In the ONC, certain characteristics of the WAC were retained but a different type of terrain portrayal and ground feature presentation was adopted in an attempt to place more emphasis on the information most needed by the US Air Force. Some of the more significant changes in the new chart design are: ease in determining safe terrain clearances, ability to interpret more rapidly certain types of terrain formations, and emphasis on critical features. Another important change is the use of finer line weights, revised symbols and type in an effort to include more cultural detail than is shown on the WAC.

The entire concept of terrain portrayal is based on regional studies to determine broad areas of different physiographic relief and geographic environment. Physiography is portrayed in perspective through the use of a shading technique. Topography is shown by contours, and is emphasized by the use of colour tints to define the over-all elevation levels on an area basis. Green is used to show relatively flat terrain at all levels of elevation and denotes the absence of extreme slope. Green also extends along the major drainage system to accent the valleys. Buff is used to portray hilly and rolling terrain generally in excess of about 6 per cent of slope. Two yellows are employed for the more rugged and mountainous terrain. However, the system incorporates flexibility by allowing for varying elevations of the two yellows on a large area basis to show terrain conditions. When charts fall within relatively flat or rolling terrain, neither of the two yellow tints will appear. On the other hand, when level areas are found in the upper elevations, the level area green overprints the yellow tint, producing a distinct yellow-green.

Additional developments in the ONC include: large open-face type, centred in each degree quadrangle of the chart, to indicate maximum terrain elevation; an increased number of spot elevations; runway patterns for aerodromes, and a greater emphasis on landmarks and obstruction data with three-dimensional symbols for the more

outstanding features. Aeronautical information subject to frequent change, such as radio frequencies, airways and terminal area controlled airspace, has been omitted.

The extent to which the more significant features of the ONC might be incorporated in an aeronautical chart to meet over-all operational needs will depend upon their compatibility with the total requirements for information on this scale chart. As an example, the current need to indicate to the pilot where he can and cannot fly may necessitate an overprinting that could affect the emphasis and methods of portrayal for other features.

In the final analysis, the design and format of an aeronautical chart must be that which best meets the total requirements for operational use and air safety.

The United States endorses the approach taken by ICAO. In fact, the principles of this approach are today being practised within the United States in the development of standards for aeronautical charts. The United States has recognized the need for co-ordination of aeronautical cartographic programmes and effective standardization, and has recently taken steps to identify and validate requirements and standards.

To be most effective, international standards for aeronautical charts must be those that adequately meet the operational needs for such charts. To achieve this, members of ICAO must, by resolute effort, provide the organization with their recommendations for such standards. This can only be accomplished by a continuous programme for evaluating the operational requirements for aeronautical charts and for developing aeronautical chart standards to meet such requirements.

The United States has established, through an organization of representatives of airspace users, the means to determine operational requirements for aeronautical charts and provide for the development and evaluation of standards to meet the requirements of all users.

Through this means of approaching requirements and standards for aeronautical charts, we have successfully developed charts for radio navigation and instrument flight which are acceptable to the users of United States airspace. By this acceptance and standardization we have eliminated costly duplication of cartographic programmes and achieved a uniformity of cartographic materials in use which we consider to be most important to air safety.

It is essential that our international standards meet current aviation needs and that we provide ICAO with the necessary changes on a continuing basis.

PROGRESS MADE IN INTERNATIONAL STANDARDIZATION OF AERONAUTICAL CHARTS AND FLIGHT INFORMATION PUBLICATIONS¹

Background paper prepared by the United States Federal Aviation Agency

Significant progress has been made in the international standardization of aeronautical charts and flight information publications since the last Cartographic Conference. A great advance in this direction was made by the International Civil Aviation Organization (ICAO) early in 1959 at a meeting held in Montreal to review existing specifica-

tions for aeronautical charts and associated flight information publications. The success of the meeting can be attributed to the systematic and logical approach taken by the participating members to the problem of international standardization. In simple terms, a review of fundamental concepts of flight operations was made and the requirements for charts were related to the functions they were intended to serve. The result is that the requirements of today's aviation can be more adequately satisfied.

¹ The original text of this paper, submitted by the United States of America, appeared as document E/CONF.36/L.56.

The Divisional Meeting of ICAO early in 1959 decided upon a complete revision of the Standards and Recommended Practices for Aeronautical Charts. These revisions included the creation of a chapter of general specifications, the introduction of three new types of charts (Radio Navigation, Terminal Area and Aeronautical Navigation Charts 1:2,000,000), the preparation of separate specifications for Instrument Approach Charts and

revised Approach Charts and the deletion of three types of charts (Aeronautical Route, Radio Facility and Aeronautical Charts at scale 1:250,000). The decision taken by this meeting has come to be known as Amendment number 34 to the International Standards and Recommended Practices for Aeronautical Charts, annex 4 to the Convention on International Civil Aviation. Amendment number 34 became applicable on 1 July 1961.

AVIATION'S CHALLENGE TO AERONAUTICAL CARTOGRAPHY¹

Background paper prepared by the United States Federal Aviation Agency

The pilot must have in the airplane aeronautical charts that meet his current needs. This can only be accomplished by a responsive aeronautical cartographic programme to provide these materials.

In providing these materials there are two areas of consideration. First, cartographic products must be responsive to the airspace user's requirements in terms of design, format and content. Secondly, cartographic methods and techniques used in producing aeronautical charts must undergo continuing improvement to keep abreast of operational requirements. This is essential to ensure the best methods of portrayal and timely production of material.

The tremendous advances in aviation and the rate of development of aircraft and air navigation aids, as well as the increased air traffic, demand accelerated and responsive aeronautical cartographic programmes to meet current operational needs.

The United States Federal Aviation Agency has recognized the existing conditions and established an organization for the purpose of co-ordinating and developing cartographic programmes which respond to the operational requirements of all users of United States airspace. Through the representatives of airspace users the needs and operational requirements are determined and defined. Once these requirements are indicated they are subjected to an investigative analysis by operationally oriented representatives of aviation and cartography. From this analysis, the validity of the requirement can be established. Following the validation of the requirement, the design and development of the aeronautical chart is undertaken by operationally oriented personnel and cartographic design engineers. Usually, prototype charts are developed, tested and evaluated, resulting in the specifications for the final product. Only in this way can requirements be validated and responsive cartographic programmes developed.

Even though a very effective means of determining operational requirements is developed, the end-product will be circumscribed by the limitations of cartographic methods and techniques. These play a critical role in determining how well an aeronautical chart can meet an operational need and how early the charts may be available for operational use.

Present-day cartographic methods and techniques can provide beautiful and accurate aeronautical charts.

However, they are time consuming and limited when faced with the problem of meeting rapidly changing aviation requirements.

The pilot's requirements today are such that he needs and should have a considerable amount of information to conduct a safe and efficient flight. We find in many instances that we cannot provide on his aeronautical chart all the information he requires. The more important information that he must have, and which cannot be shown on his chart, we are attempting to provide through supplemental publications. Through our inability to provide all of the information on small-scale aeronautical charts, we are forced to produce additional charts at larger scales which, of course, results in additional numbers of charts and pieces of paper to be handled in the cockpit. The charts and supplemental publications are far too numerous to provide efficient operations in the airplane.

The present cartographic methods and techniques consume entirely too much time and do not make possible the rapid, frequent publication of the data required by the pilot. As an example, the WACs of the United States are published on a once-a-year basis, which means that the pilot cannot depend on these charts for current, ephemeral-type information. Being unable to provide current, up-to-date information on these charts continuously, we are forced into supplemental publications of various types. The situation is even more critical in the radio navigation charts which we provide for instrument flying in our air traffic system. These charts are produced on a twenty-eight-day cycle and also require supplemental publications. Because of the twenty-eight-day publication cycle, it is incumbent upon the user to keep his charts up to date through frequent notices of changes. Some of the more serious conditions existing are the number of charts required, the large size of the sheets of paper and the large amount of material needed in addition to the charts. The volume and unwieldiness of the material place a real burden on the pilot, particularly under instrument flying conditions.

A new look must be given to this area and recognition that the art of cartographic expression, so long in use, falls short of meeting the aviation requirements of today. Cartographic programmes must be adaptable and responsive to the accelerated demands of the airspace user. In the aeronautical cartographic field, we need a concentrated effort in the development of new methods, new techniques, new equipment and new materials.

Meeting the airspace user's requirements for aeronautical charts is a major challenge in the field of cartography.

¹ The original text of this paper, submitted by the United States of America, appeared as document E/CONF.36/L.57.

AGENDA ITEM 17

Specifications of the International Map of the World on the Millionth Scale (IMW)

TENTATIVE SPECIFICATIONS FOR INTERNATIONAL 1:1,000,000 GENERAL MAPS OF CHINA¹

I. FOREWORD

The international map conference held in London in 1909 discussed the unified projection, scale and style and map symbols to be shown on international general maps on the scale 1:1,000,000. A second conference was held in Paris in 1913, but no agreement was reached on the format at either of the two conferences. The case was brought up again for discussion at the Second United Nations Regional Cartographic Conference for Asia and the Far East held in Tokyo from 20 October to 1 November 1958 and some amendments to the projection were suggested to meet present requirements.

The format for international maps on the scale 1:1,000,000 is also subject to change according to the particular region covered.

The preparation of 1:1,000,000 general maps of China began in 1933 with the compilation of twenty-seven sheets which were completed in 1938. After revision, the maps were published in monochrome and multi-colour editions during the Second World War. The maps have become obsolete both in content and specifications in the past decade, although the specifications used for compiling the map sheets are based largely on the international specifications. For recompiling and revising the maps sheets, we have prepared these Tentative Standard Specifications for International 1:1,000,000 General Maps of China based on our actual requirements.

II. CONTENTS OF THE TENTATIVE STANDARD SPECIFICATIONS FOR INTERNATIONAL 1:1,000,000 MAPS OF CHINA

1. *Sheet coverage.* The limiting meridians and parallels for each 1:1,000,000 map sheet shall be 6 degrees by 4 degrees (between 60° N and 60° S latitude).

2. *Sheet lines.* Sheet lines shall be established at intervals of 6 degrees from Greenwich and 4 degrees from the equator. The neat line of a sheet may be broken to include small land areas or special features which lie in an adjacent sheet featuring open water.

3. *Sheet numbers.* Sheet numbers shall be prepared according to the international unified 1:1,000,000 sheet numbering system, as follows:

(a) The columns extending from the equator to 88° N and S latitude are designated by letters from A to V; the zones are numbered from 1 to 60, beginning at 180° E and progressing eastward;

(b) Each individual sheet is identified by a combination of letter and Arabic number, with "N" and "S" placed before the sheet number to indicate the northern and southern hemispheres.

4. *Map series number.* The series number 1301 used by the United States Army Map Service will be adopted for our map sheets temporarily, in line with the unified cataloguing of Sino-American source materials, but the designation "CMS", which stands for China Map Service, shall be placed before the series number. The complete series number shall be "CMS-1301".

5. *Sheet name.* The sheet name is selected from the most prominent cultural or physical feature falling within the map area.

6. *Projection.* The projection shall be the Lambert Conic Conformal, which was agreed upon at the Second United Nations Regional Cartographic Conference for Asia and the Far East in October 1958. Its characteristics are as follows:

(a) Meridians (longitude) appear as straight lines;

(b) Parallels (latitude) appear as concentric arcs whose centres lie on the line representing the central meridian;

(c) Co-ordinate values necessary for plotting sheet intersections of China's 1:1,000,000 maps have been computed at the one-fifth reduction scale and are contained in the Tables for Plotting of International 1:1,000,000 Maps.

7. *Names.* The size of letters indicates the importance of features, while letter types or colours indicate the types of features. Normal spacing should be used for names, except for those of area and line features, which shall be extended if space permits. Detailed specifications are contained in the Map Symbols for International 1:1,000,000 Maps. Place names of importance shall be bilingual Chinese and English.

8. *Sheet size.* Sheet size varies with the change of latitude, particularly in China, a country of very large area. For convenience of binding and storage, all sheets of this series will have the same format, using the smallest sheet falling in the southernmost part of the country as the standard sheet size.

9. *Colour.* Besides the basic colours of black, red, blue and brown for the map sheets, there shall be colour shades of blue to show water depth and shades of green, yellow, brown and red to show elevations. Colours for cultural features are shown in the Map Symbols for 1:1,000,000 Maps. Specifications for colour shades are contained in the gradient tint diagram shown in figure 104.

10. *Contour lines, depth curves and elevation tints:*

(a) *Contour lines.* The vertical datum is based on mean sea level; heights are given in metres. Contour intervals vary with terrain elevation: 150-metre intervals for elevations under 300 metres; 300-metre intervals for 300 to 500-metre elevations; 1,000-metre intervals for elevations over 5,000 metres;

¹ The original text of this paper, submitted by China, appeared as document E/CONF 36/L 66.

(b) *Depth curves.* Depth curves are based on mean sea level; depths are given in metres at intervals of 150, 300, 900 and 3,000 metres;

(c) The land lower than mean sea level shall be drawn according to its shape and shown in the gradient tint diagram;

(d) Important terrain points shall have elevation values in addition to contours and elevation tints. Form lines shall be delineated for significant terrain having less than the value of a contour line;

(e) Depth values shall be drawn together with depth curves to show hydrographic conformation, particularly in deeper areas. Along the coast shall be a nine-metre depth curve, but the curve shall not be used as the range of gradient tint;

(f) The gradient tint diagram is reproduced in figure 104;

(g) *Notes:*

- (1) Figures appearing on both sides of the gradient tint diagram are the values for contour lines and depth curves;
- (2) The range of the elevation tints is shown by a uniform space on the diagram regardless of the elevation value;
- (3) Contour lines and their values are printed in brown; lines indicating mean sea level and depth curves are printed in deep blue; labels for snow lines, depression limits and metres are printed in black;
- (4) The positions of snow lines are based on the level of the highest and lowest snow land falling within the map area;
- (5) Perennial snowfields (above the snow line), glaciers, lakes and double-line streams shall not be shown by elevation tones, but swamps, dry lakes, coastal brushwood and muddy areas shall be shown according to their elevations. Fore-shore sand and mud shall be shown by the first layer of tint of coastal hydrography;
- (6) Streams and lakes are also shown in gradient tints.

11. *Sheet intersections, ticks, parallels and meridians.* Both the margin and the neat line shall appear on the map. Values of parallels and meridians, and letter designation and number shall be located between the margin and the neat line. The meridian values beginning at 180° and the parallel values starting from the South Pole shall be located outside the margin. The graticules of the map sheets shall be at intervals of one degree. The meridians and parallels shall be divided into five-minute units, six of which (thirty minutes) will form a co-ordinate. Easting lines shall be given a code number of I, II, III, etc. and northing lines a letter designation of a, b, c, etc. which will be used for target reporting.

12. *Marginal data.* The contents of the marginal data can be referred to in the Map Style Sheet for 1:1,000,000 Maps. The following are the explanations for the marginal notes:

(a) *Upper margin data:*

- (1) Upper left corner: series name—international 1:1,000,000 Maps of China;

- (2) Upper margin, centre: sheet name—names are contained in the Index to Adjoining Sheets of 1:1,000,000 Maps;

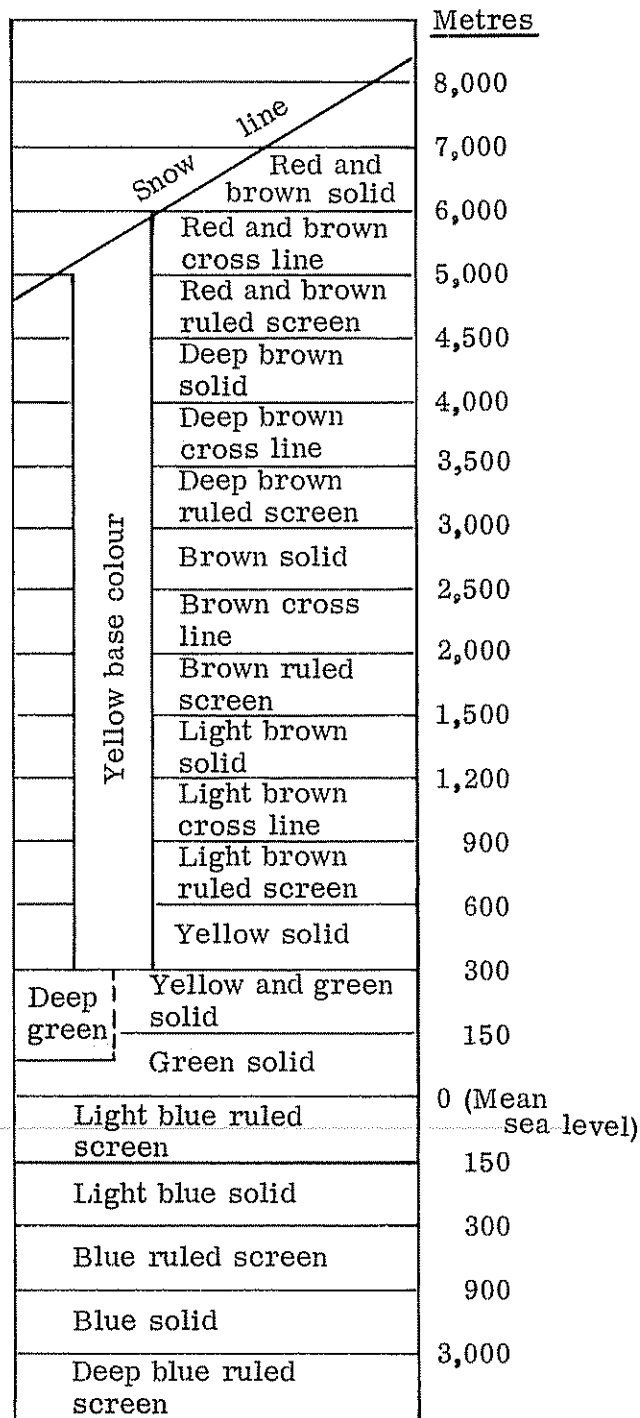

Figure 104. Gradient tint diagram for international 1:1,000,000 general maps of China

- (3) Upper right corner: sheet number and series number, as, for example, NG-50 CMS-1301;
- (4) Upper left, centre: edition number, as Edition 2;
- (5) Upper right, centre: warning note "CHINESE"

IDEOGRAMS ARE READ FROM LEFT TO RIGHT

(b) *Right margin data—from top:*

- (1) Reference note: as "Refer to this map as International 1:1,000,000, China, NG-50, Edition 2";
- (2) Magnetic line diagram: the diagram shall be prepared from the latest magnetic information to show mean magnetic declination within the map area and to give necessary explanations;
- (3) Colour guide: Showing the colours appearing on the map;
- (4) Magnetic declination diagram: Using the central meridian of a map sheet and the magnetic declination value at centre of the sheet for illustrations;
- (5) Gradient tint diagram: See paragraph 10, above;
- (6) Conversion table: Conversion between metres, feet and the Chinese scale;
- (7) Special notes: If special notes are added, they can be placed between gradient tint diagrams and conversion tables;

(c) *Lower margin:*

- (1) Scale: the scale bar of 15 cm length is located in the lower margin centre; it shows kilometres, Chinese miles, miles and nautical miles;
- (2) Left of the scale bar:
 - (a) Series number: "CMS-1301";
 - (b) Edition number: indicates the current edition and the publication date of previous editions;
 - (c) Credit note: states briefly publishing agency and date, compilation methods, source material and reference information utilized, and other information;
 - (d) Vertical datum note: states datum planes and elevation measuring units, for example, "Vertical datum is based on mean sea level";
 - (e) Projection note: "Projection: Lambert Conic Conformal projection";
 - (f) Hydrographic datum note: identifies the datum plane and depth measuring unit, for example, "Hydrographic datum: Mean High Water of Spring Tides along China Coast, Depths in Metres";
 - (g) Other notes: example, "USERS NOTING ERRORS OR OMISSIONS ON THE MAP ARE URGED TO NOTIFY THE CHIEF, TOPOGRAPHIC SERVICE, CCSF". If special notes are to be added these can be placed between the vertical datum note and the credit note;
 - (h) Reference note: same as the one on the upper right corner;
- (3) Lower margin, centre, under the bar scale:
 - (a) Index to boundaries note: identifies the administrative division of provinces or other political divisions of similar administrative importance;
 - (b) Index to adjoining sheets diagram: the diagram has nine divisions. The division representing the sheet itself shall show additional slant lines, as well as longitude and latitude, while the divisions for surrounding sheets shall

show only sheet names and sheet numbers. Only the sheet number shall be listed for the sheets uncompiled for falling in foreign countries. Divisions where no sheets exist shall be omitted. The diagram will show coast lines in black and the first layer of the gradient tints, if there are hydrographic features, and also sheet lines and sheet numbers in blue to indicate the existence of the international 1:1,000,000 aeronautical charts. A note will be located under the diagram, "Sheet lines and sheet numbers in blue indicate the international 1:1,000,000 aeronautical charts". A note, "The sheet lines and sheet numbers of the international 1:1,000,000 aeronautical charts are the same as listed in the diagram" will be substituted for the above note, if both sheet lines and sheet numbers are the same;

(c) Coverage diagram: the coverage diagram shows in graphic form the methods of compilation, source materials used, scale, publishing agency, date and reliability;

(4) Lower right corner:

- (a) Publishing agency, printing date and quantity;
- (b) Legend: the legend shall show all symbols and names appearing on the maps in accordance with The Map Symbols for International 1:1,000,000 Maps of China.

13. *Index to boundaries.* The index to boundaries diagram will include the following information:

- (a) International boundaries;
- (b) Provincial boundaries;
- (c) Mongolian boundaries;
- (d) Mongolian tribe boundaries;
- (e) Special boundaries;
- (f) Shorelines and first layer of gradient tints. Shorelines are printed in black;
- (g) Names of foreign countries (names which cannot be listed will be numbered under the diagram);
- (h) Names of other administrative areas shall be numbered under the diagram.

14. *Edition number*

(a) *Location:*

- (1) Lower left margin: shows the current edition and dates of previous editions;
- (2) Upper left margin: current edition;
- (3) In the reference note: current edition;

(b) *Determination of edition date:*

- (1) Reproduction date shall be used for the edition date of the sheets redrawn and reproduced;
- (2) Newly compiled or revised sheets shall be given the edition date on which the sheet's proof copy is checked;

(c) *Determination of edition number.* The advancement of an edition number shall be given to the newly issued sheets whose contents have been revised owing to errors discovered on the maps of previous editions.

15. *Legend.* The contents of the legend are explained as follows, but specifications for the symbols have not been prescribed. A table of map symbols is reproduced in figure 105; the symbol numbers mentioned below refer to those shown in the figure.

(a) *Features and names in blue:*

- (1) Longitude and latitude ticks on the upper and right margins, and notes under the index of adjoining sheets;
- (2) Names of oceans: use types of clearface italic caps, as symbol 202;
- (3) Names of streams and lakes: use clearface italic caps, as symbol 202;
- (4) Names of harbours: use clearface italic caps, as symbol 203;
- (5) Names of rivers:
 - (a) Perennial rivers, as symbol 204 (with eddy);
 - (b) Intermittent rivers, as symbol 205;
 - (c) Unclassified streams, as symbol 206. When the stream's width is less than 500 metres, it shall be drawn as a single line; if its length is less than twenty kilometres, the symbol shall be omitted. Intermittent river, unclassified river and eddy shall be drawn as broken lines (*see* symbols 204 to 206);
- (6) Lakes:
 - (a) Perennial lakes shall be drawn as symbol 207 if larger than 1.5 square kilometres;
 - (b) Intermittent lakes shall be drawn as symbol 208 if larger than ten square kilometres;
 - (c) Salt lakes shall be drawn as symbol 209 if larger than 1.5 square kilometres;
- (7) Wells and springs: These are only used in desert areas, as symbols 211 and 212;
- (8) Rapids and falls: these are only used when well known, or obstructive to navigation, or useful for hydro works. *See* symbols 213 and 214;
- (9) Dams: only famous dams shall be shown, as symbol 215;
- (10) Canals: the feature shall in addition carry the label "tunnel", as in symbol 216, if a tunnel exists;
- (11) Swamps and land subject to inundation: these are shown as symbols 217 and 218 when their sizes are over ten square kilometres;
- (12) Salt evaporation: this shall be shown as symbol 219 when its size is over five square kilometres;
- (13) Rice paddies: these features are only shown in border or mountainous areas, as symbol 220;
- (14) Grass: this symbol is only shown in pasture areas, as symbol 221;
- (15) Shoreline: the symbol shall be omitted when the shore is composed of rocks (symbol 210);
- (16) Aqueduct: this feature is only shown when over thirty kilometres in length (symbol 222);
- (17) Glacier: symbol 223;
- (18) Snowfield: this would represent a perennial snowfield and is drawn true to shape;
- (19) Depth curve: symbol 225;

(20) Depth values: these shall be shown only in deep waters;

(b) *Features and names in red:*

- (1) Warning note: "CHINESE IDEOGRAMS ARE READ FROM LEFT TO RIGHT";
- (2) Civil airport: name of the airport shall be omitted when it is the same as the place name. Otherwise it shall be shown in black, as symbol 306;
- (3) Lighthouse: this shall be shown as symbol 305 regardless of whether it is in operation or not;
- (4) Province name: symbol 302;
- (5) Tribe district name: symbol 303;
- (6) Foreign country name: symbol 301;
- (7) Port name: ports designated for foreign trade shall be shown as symbol 304;
- (8) Roads:
 - (a) Main road: national or provincial, symbol 307;
 - (b) Secondary road: district or roads managed by public or commercial organizations, symbol 308;
 - (c) Other roads: roads other than the above and whose traffic situation is unknown shall appear as symbol 309;
 - (d) Cart track: this shall be shown only in areas where transportation relies largely on manually-operated or animal-drawn carts (symbol 310);
 - (e) Notes:
 - (1) Roads shall be shown unbroken when they extend across streams by bridges; otherwise roads shall be shown as above;
 - (2) Bridges across double-line streams, and 500-metre long tunnels shall be shown;
- (9) Built-up areas: these areas are indicated by an over-all screened red tint (symbol 311);
- (10) Mountain passes: only important or famous passes are shown (symbol 312);

(c) *Features and names in brown:*

- (1) Contour value: symbol 401;
- (2) Contour lines: symbol 402;
- (3) Supplementary contours: symbol 403;
- (4) Form lines: this symbol does not give an accurate representation of the terrain (symbol 404);
- (5) Cliff: this shall be shown when it is greater than the contour interval (*see* symbol 405);
- (6) Desert: symbol 406;
- (7) Sand beach: symbol 407;
- (8) Levee: levees over ten kilometres long shall be shown as symbol 408;

(d) *Features and names in black:*

- (1) Place names:
 - (a) Grass name: symbol 113;
 - (b) Desert name: symbol 112;
 - (c) Basin area: symbol 111;

國際百萬分一中國輿圖圖式

編號	項目	符號	規格	編號	項目	符號	規格	編號	項目	符號	規格
101	一級居住地名	廣州		124	水面下沙灘			147	寺廟	⊕	
102	二級居住地名	福州		125	岩礁			148		⊕	
103	三級居住地名	梧州		126	暗礁	•		149	蒙旗	⊕	
104	四級居住地名	•••		127	通海岩	•		150	十倫	•	
105	五級居住地名	••		128	潮流流向箭頭			151	壽辰	△	
106	盟名	伊克昭盟		129	危險範圍			152	鄂博	△	
107	旗名	茂明安旗		130	海航線	-----		153	國都	⊕	
108	旗名	二十五旗		131	海電線	———		154	省會或特別市	⊕	
109	特種區域名	江心區		132	電訊線	-----		155	縣治或政治管理局	⊕	
110	島嶼名	金門島		134	高壓線	-----		156	鄉鎮	⊕	
111	盆地名	柴達木盆地		135	無線電臺	⊕		157	村莊	⊕	
112	沙漠名	白龍堆沙漠		136	輸油管	-----		158	國界	———	
113	草地名	蒙古草地		137	礦場	•		159	省界或特別市界	-----	
114	山脈名	祁連山		138	油井	••		160	盟界	-----	
115	山峯名	具山 蘇聯		139	碉堡	○		161	旗界	-----	
116	飛機場名	松山機場		140	關隘	△		162	特殊界	-----	
117	鐵路名	平漢鐵路		141	廢墟			163	界標	•	
118	三角點及其高程	△ 123		142	古陵	⊕		164	雙軌尋常鐵路	———	
119	天文點及其座標	•		143	西瓜休息所	⊕		165	單軌尋常鐵路	———	
120	標高點及其高程	⊕ 123		144	空中索道	———		166	雙軌鐵路	———	
121	最高高程點及其高程	⊕ 123		145	長城	———		167	單軌鐵路	———	
122	山峯	△		146	長柵	———		168	特殊鐵路	———	
123	停泊所	↓		133	電訊局	⊕					

編號	項目	符號	規格	編號	項目	符號	規格	編號	項目	符號	規格
201	海洋名	東海		210	海岸線			219	鹽田		
202	江河湖泊名	珠江		211	水井	⊕		220	棉田		
203	港灣名	廣州灣		212	泉源	•		221	草地		
204	常年河川			213	急流			222	溝水管	-----	
205	時令河川			214	瀑布			223	水源		
206	未測定河川			215	水渠			224	水深點	2 123	
207	常年湖泊			216	運河			225	水深線	———	
208	時令湖泊			217	濕地						
209	鹽水湖			218	泥濱						

編號	項目	符號	規格	編號	項目	符號	規格	編號	項目	符號	規格
301	外國名	日本		305	燈塔	•		309	其他公路	-----	
302	省名	四川		306	民用機場	⊕		310	大道	-----	
303	縣名	昭伊		307	主要公路	———		311	真形居住地點	⊕	
304	商埠	•		308	次要公路	-----		312	山口	⊕	

編號	項目	符號	規格	編號	項目	符號	規格	編號	項目	符號	規格
401	標高列註記			404	地形線			407	岸上沙灘		
402	等高線			405	懸崖			408	堤壩	———	
403	近似等高線			406	沙漠						

Figure 105. Map symbols for international 1:1,000,000 general maps of China

- (d) Mongolian district name: symbol 106;
 (e) Mongolian tribe name: symbol 107;
 (f) Tribal names: symbol 108;
 (g) Special area name: symbol 109;
 (h) Island name (including peninsula): symbol 110;
- (2) Populated places:
- (a) These shall be classified into five administrative areas:
- (1) Capital: symbol 153;
 - (2) Provincial capital, special city: symbol 154;
 - (3) District, country, administrative bureau: symbol 155;
 - (4) Town: symbol 156;
 - (5) Village: symbol 157;
- (b) Large populated places are shown, true to scale, by an outlined red tinted area with prescribed symbols;
- (c) Names of populated places are shown in different size type depending upon population:
- (1) Populated place, first importance, over 500,000 population: symbol 101;
 - (2) Populated place, second importance, 100,000 to 500,000 population: symbol 102;
 - (3) Populated place, third importance, 20,000 to 100,000 population: symbol 103;
 - (4) Populated place, fourth importance, 5,000 to 20,000 population: symbol 104;
 - (5) Populated place, fifth importance, under 5,000 population: symbol 105;
- (d) The number of names selected to appear on the map shall depend on the density of features. In this case, names of districts or equivalent shall be shown on the map, while names of towns or villages shall be limited because of congestion. The word "shih" shall be added after the name of special cities for identification. The word "hsien" shall be added after the single-word name of districts in conformity with habitual use;
- (e) If administrative names and place names are not in agreement, the former shall be the main name and the latter the alternative name;
- (3) Boundaries:
- (a) International: the dots of the symbol shall be omitted when the boundaries are indefinite (symbol 158);
 - (b) Provincial, special city: symbol 159;
 - (c) Mongolian tribes: symbol 160;
 - (d) Mongolian district: symbol 161;
 - (e) Special: symbol 162;
 - (f) Boundary marker, international: symbol 163;
 - (g) Dots or dashes of the symbol shall be omitted when boundaries are indefinite.
- Where two or more boundaries coincide, only the symbol representing the higher-ranking boundaries is shown;
- (4) Other names:
- (a) Mountain range: size and style of type as in symbol 114;
 - (b) Hill top: size and style of type as in symbol 115;
 - (c) Airport: size and style of type as in symbol 116;
 - (d) Railroad: size and style of type as in symbol 117;
- (5) Railroads:
- (a) Normal gauge, double track, 4' 8 1/2" gauge: symbol 164;
 - (b) Normal gauge, single track, 4' 8 1/2" gauge: symbol 165;
 - (c) Narrow gauge, double track, 3' 6" gauge: symbol 166;
 - (d) Narrow gauge, single track, 3' 6" gauge: symbol 167;
 - (e) Special gauge: gauge width shall be indicated by labelling (symbol 168);
 - (f) Under construction: symbol shall be broken when the railroad is under construction;
 - (g) Car line: special gauge symbol shall be used for the car line with proper labelling;
 - (h) Railroad tunnels more than two kilometres long shall be indicated by labelling;
 - (i) Railroad bridges are not necessarily shown. If no bridges exist, the railroad symbol shall be broken;
 - (j) Railroad stations shall not be shown;
- (6) Aerial cableways: only the cableway used as main transportation and over a length of ten kilometres shall be shown (symbol 144);
- (7) Telecommunication offices, telephone and telegraph lines:
- (a) Telecommunication offices: symbol 135;
 - (b) Telephone and telegraph lines: these are identified by labelling as in symbol 132;
 - (c) These symbols are shown only in border areas or sparsely developed areas;
 - (d) These symbols are omitted along roads;
- (8) Navigation routes: these shall be indicated by the labellings of mileage and route destination (symbol 130);
- (9) Under-water cables: the labelling of destination shall be added (symbol 131);
- (10) Oil pipes: pipelines over thirty kilometres long shall be shown (symbol 136);
- (11) Power transmission lines: these are shown only in areas of sparse development or between the plant and the station;
- (12) Mines: these shall be indicated by labelling as to type of mine (symbol 137);
- (13) Oil wells: these shall be indicated by labelling (symbol 138);
- (14) Fortresses: only historical fortresses or those used as landmarks are shown (symbol 139);

- (15) Radio stations: radio stations used for communication shall be shown (symbol 135);
- (16) Ruins: only historical ruins are shown (symbol 141);
- (17) Ancient cemeteries: only cemeteries of late kings and sages are shown (symbol 142);
- (18) Travellers' hostels: these shall be shown only in deserts (symbol 143);
- (19) Mountain passes: only mountain passes of military and communication importance are shown (symbol 140);
- (20) Triangulation points, astronomic positions, spot elevations, hill tops and their labellings are shown as symbols 118, 119, 120 and 122, respectively;
- (21) Highest elevation: the highest elevation on the sheet shall be shown as symbol 121;
- (22) Anchorage: anchorage for commercial vessels (symbol 123);
- (23) Sunken rock: symbol 126;
- (24) Foreshore, flat sand: symbol 124;
- (25) Rock, bare or awash: symbol 127;
- (26) Reef or ledge: symbol 125;
- (27) Current: symbol 128;
- (28) Limit of danger line: symbol 129;
- (29) Palaces: only palaces for border tribes are shown (symbol 148);
- (30) Mongolian tribes: symbol 149;
- (31) Mongolian administrative areas: symbol 150;
- (32) Yurts: symbol 151;
- (33) Nomadic boundaries: symbol 152;
- (34) Temples: only temples in the Mongolian area and Tibet are shown (symbol 147);
- (35) Great walls: only historical ones are shown (symbol 145).

VIEWS ON SHEET LINE AND PROJECTION SYSTEMS FOR IMW AND WAC SERIES¹

Paper submitted by Japan

The IMW should meet the urgent need for a standard basic map of every region.

Relating to the sheet line system, attention is drawn to the following note, included in the International Standards and Recommended Practices, Aeronautical Charts, Annex 4, adopted by the Council of the International Civil Aviation Organization in 1960:

"Contracting States may vary the sheet lines if required to meet special geographical or other requirements, ensuring that such variation does not leave any land area unmapped. However, the value of adopting identical sheet lines for the ICAO 1:1,000,000 charts and corres-

ponding sheets of the International Map of the World is emphasized."

Along the same lines, it is suggested that the following note be added to the IMW specification dealing with the sheet line system:

"The sheet lines of the IMW may be varied to meet the geographical situation of a mapping area, but the IMW reference system should be retained."

With regard to the projection system, it is believed that the ICAO-WAC projections may be adopted for the IMW in accordance with resolution 31 of the Second United Nations Regional Cartographic Conference for Asia and the Far East held in Tokyo, with the inclusion of the following note:

"When the sheet lines are varied, it is permissible to vary the standard parallels."

¹ The original text of this paper appeared as document E/CONF. 36/L. 6.

SPECIFICATIONS FOR THE IMW SERIES¹

Paper submitted by Thailand

The International Map of the World on the Millionth Scale in its universally accepted sense is based on a definite concept. Mapping agencies of various nations should adhere to the same principles and follow the same procedure so that the series, in spite of being produced by different agencies, remains consistent.

If the component maps of the same series come out in various formats, determined by the discretion and convenience of the producers, confusion will result among the general users (some of whom may not have any knowledge of cartography). Thus, the principles and some particular procedures for the publication of IMW sheets should be definitely indicated. The specifications should

be so clear as to leave no room for doubt. Ambiguity and optional practices must be avoided.

The following outlines the views of the Thai delegation on some important items to be considered for achieving consistency and uniformity.

PROJECTION

The projection, defined in the existing specifications as one of those maintaining conformal character, is considered appropriate for IMW. The only desirable modification is to indicate the specific one.

To select a projection from all those maintaining conformality, the following factors should be considered in order to facilitate the immediate production of IMW sheets:

¹ The original text of this paper appeared as document E/CONF. 36/L. 7.

(a) Type of projection of other existing map series which are generally used as source material for compiling IMW sheets;

(b) Possibility of adopting the projection used in other one millionth-scale map series having the greatest coverage at present.

SHEET LINES

Sheet lines set by the current specifications are considered appropriate but more emphasis is required on the numbering system for joining east and west sheets into one sheet and on the corresponding interval of latitude for such merging. In this case, rules for determining the sheet reference number are to be established.

CONVENTIONAL SIGNS

The symbols for features commonly accepted in all countries, such as those for railways, highways, buildings, do not raise any problem. In certain cases where features represent individual national forms or culture, symbols should be shown in the specifications.

ROMANIZATION AND/OR TRANSLITERATION

Among the countries where the official language or languages do not use the Latin alphabet, any romanization and/or transliteration system adopted for geographical names should leave room for a wide range of possibilities.

For example, the transliteration of place names should adhere to the actual pronunciation of the local people. In the case of internationally-known names, it is proposed that the local pronunciation be given in brackets, for example: VIENTIANE [WIANG CHAN]. If romanization and transliteration are employed strictly, accurate presentation of the local pronunciation of names would be impossible. It is proposed that a system of simple representation of sounds be used so that local customary pronunciation would be retained as far as possible.

UNITS OF MEASUREMENT BOTH HORIZONTAL AND VERTICAL

One system for measuring should be adopted, and the metric system is recommended.

MARGINAL NOTES

Details for marginal information should be standardized, including the place and arrangement for each item. A style sheet should be adopted together with the specifications.

With the adoption of adequate specifications, it is hoped that IMW maps will come out in a unified format, thus offering the maximum benefits to the user, regardless of his knowledge of mapping. Above all, the International Map of the World will then be really worthy of its name.

AGENDA ITEM 18

Geographical names

RECENT DEVELOPMENTS IN INTERNATIONAL STANDARDIZATION OF GEOGRAPHIC NAMES: PROGRESS BETWEEN THE SECOND AND THIRD REGIONAL CARTOGRAPHIC CONFERENCES FOR ASIA AND THE FAR EAST¹

Background paper by the United States of America

The Mussoorie Conference in 1955 adopted resolution XI, which stated:

"The Conference

"1. *Commends* to the notice of the Governments attending the Conference the suggestion of the Government of the United States of America, in paragraph 6 of page 16 of document E/CONF.18/A/L.3 dated 1 February 1955, viz: "...The United States Government would be willing to co-operate in drafting a general framework for a programme looking toward maximum international uniformity in the writing of geographical names for consideration by the United Nations Economic and Social Council, or by an International Conference called by the Council for that purpose, or in drafting an agenda for such a Conference"; and

"2. *Recommends* that a Committee should be set up under the auspices of the United Nations, on the lines proposed by the Government of the United States of America, and that the Governments of this Region should appoint experts to participate in the deliberations."

Pursuant to this resolution, the United Nations requested the Executive Secretary of the Board on Geographic Names in the United States to draft a programme looking toward international standardization of geographic names. The draft was prepared and was circulated by the United Nations under the date of 15 September 1958 (E/CONF.25/L.10 and Add.1 and 2).

The Second Conference, held at Tokyo in October-November 1958, adopted as resolution 32 the following:

"The Conference,

"Recognizing the necessity for international standardization of names, spelling and transliteration,

"Noting that at present only a small measure of international agreement on transliteration has been achieved,

"1. *Recommends* for consideration the principles outlined in the paper prepared by the Secretariat, dated 15 September 1958, and in the background paper submitted by the United Kingdom, dated 4 September 1956;

"2. *Suggests* that the most suitable agency for the implementation of international standardization of

names, spelling and transliteration is the United Nations acting by way of a parent body composed of national representatives and free to confer with appropriate authorities, official and academic, through subordinate study groups concerned with regional problems."

In furtherance of this resolution, the Economic and Social Council of the United Nations (ECOSOC) adopted resolution 715 A (XXVII), requesting the Secretary-General 1) to set up a meeting of experts on geographic names to identify the technical problems of domestic standardization of geographic names and make appropriate recommendations, and 2) to invite Governments to make such experts available for a meeting. The resolution is reproduced in annex I to the present paper.

In response to the United Nations invitation to Member States to name experts to participate, six States did so. The group met at United Nations Headquarters from 20 June to 1 July 1960. Observers were also present from three Member States that did not provide experts. The group produced and forwarded to the Economic and Social Council a unanimous report covering the questions referred to it. The report, document E/3441, was circulated on 7 February 1961, and received favourable comment from Governments.

The Seventh International Congress of Onomastic Sciences, held at Firenze and Pisa from 4 to 8 April 1961, after discussion of the report adopted a resolution endorsing it, commending it to its members and to Governments for study and implementation, offering co-operation and urging the Economic and Social Council to publish it in readily available form. A copy of the resolution is reproduced in annex II.

The Economic and Social Council formally took up the report at its 19-28 April 1961 meeting and by a vote of 15 to 0, with 2 abstentions, adopted resolution 814 (XXXI), reproduced in annex III, which commended the report, recommended that Governments of Member States adopt and implement the recommendations in the report, emphasize field investigations and co-ordination with local authorities in standardizing place names, and keep the Secretary-General informed of progress. The resolution also requested the Secretary-General to publish the report in *World Cartography*, to assist in establishing national names authorities and linguistic system working groups, and to report to the Council within two years on progress and on the desirability of an international conference on the subject.

¹ The original text of this paper appeared as document E/CONF.36/L.58.

Subsequent to the meeting of the group of experts, the Directing Council of the Pan American Institute of Geography and History (PAIGH) requested the Working Group on Geographic Terms, which had been set up by the Institute's Commission on Geography, to assume the added function of promoting international standardization of geographic names among its member states. A plan of work for this activity was prepared by the Working Group and approved at the Consultation on Geography and the simultaneous Reunion of the Institute at Buenos Aires, 31 July-16 August 1961; it is reproduced in annex IV.

The calling of the group of experts and its report were both predicated on the general international consensus that international standardization should be based upon standardization of their own names by individual countries. The report outlined a series of basic problems requiring solution in national standardization programmes, as an aid in the establishment and execution of such programmes. It also made broad recommendations for approaches to these problems, but without infringing on the prerogative of individual countries to make their own decisions.

Under the problem "How to set up a name standardizing body in a country that does not have one?", it was stated that "It would seem more important that the organization fit the general pattern of administrative structure of a country than that the authorities in various countries be similar". The first recommendation was addressed to this problem. It said, in part, "As an initial step in international standardization, countries that have not begun to exercise their prerogative of standardizing their own names are urged to do so. This function should be carried out by a national names authority. The hierarchical place of such authority should be consonant with the governmental structure in each country. The composition and procedures of such a body should be such as to give the greatest chance of success in a name standardization programme appropriate for that country". In another part of Recommendation I it was pointed out that "The personnel employed in the initial processes of assembling information on names should have training adequate to recognize and deal with the linguistic and geographic phenomena that they are likely to encounter. It is important to take into account the problem presented by cartography (i.e., the existence of maps already in use and the constant production of new maps for a multitude of purposes), but a proper treatment of names requires a specialized knowledge. There must be close liaison between national cartographic agencies and national names authorities in their parallel programmes".

The first requisite in a co-operative international standardization programme is the establishment of a names authority in each country. The ECOSOC report offers broad suggestions on this, and points out that where needed and requested there is the possibility of technical assistance. The PAIGH meeting in Buenos Aires adopted a resolution requesting that negotiations be initiated with the Organization of American States for five fellowships to train personnel in name standardization work.

It would appear advisable for the States of Asia and the Far East to give careful study to the group of experts' report, and to proceed as speedily as possible to establish national names authorities competent to deal with the kinds of problems that must be faced. It would also seem advisable for the national cartographic agencies

to lend all possible support to the establishment of parallel programmes of name standardization.

ANNEX I

Resolution adopted by the Economic and Social Council

715 (XXVII). INTERNATIONAL CO-OPERATION ON CARTOGRAPHY

A

The Economic and Social Council,

Having considered the report of the Secretary-General concerning international co-operation on cartography,

Noting the draft programme for achieving international uniformity in the writing of geographical names, which was transmitted by the Secretary-General to the Governments of Member States for comment,

Considering the comments on the draft programme that have been received from the Governments,

1. *Requests* the Secretary-General:

(a) To provide encouragement and guidance to those nations which have no national organization for the standardization and co-ordination of geographical names to establish such an organization and to produce national gazetteers at an early date;

(b) To take the necessary steps to ensure the following central clearing-house functions for geographical names:

(i) Collection of gazetteers and information concerning the technical procedures that each Member State has adopted for the standardization of domestic names;

(ii) Collection of information on the techniques and systems used by each Member State in the transliteration of the geographical names of other countries;

(iii) Dissemination to Member States and, upon request, to any working groups established on a common linguistic basis, of all documents and information collected, utilizing existing United Nations periodicals wherever feasible;

2. *Further requests* the Secretary-General:

(a) To set up a small group of consultants chosen, with due regard to equitable geographic distribution and to the different linguistic systems of the world, from those countries having widest experience of the problems of geographical names:

(i) To consider the technical problems of domestic standardization of geographical names, including the preparation of a statement of the general and regional problems involved, and to prepare draft recommendations for the procedures, principally linguistic, that might be followed in the standardization of their own names by individual countries;

(ii) To report to the Council at an appropriate session, in the light of its discussion on the above points, on the desirability of holding an international conference on this subject and of the sponsoring of working groups based on common linguistic systems;

(b) To invite Governments of countries interested and experienced in the question to make available, at his request and at their own expense, consultants to serve on the above group.

ANNEX II

Resolution adopted by the Seventh International Congress of Onomastic Sciences

Firenze, 8 April 1961

Whereas: the International Congress of Onomastic Sciences has for more than a decade interested itself in international standardization of geographic names, and

Whereas: the basic elements of a realistic international standardization program, on which many countries have agreed, were worked out at the International Congress of Onomastic Sciences in 1955, and

Whereas: the findings and recommendations of the Group of Experts on Geographical Names set forth in the United Nations

Economic and Social Council document E/3441 are consistent with those elements and program, and

Whereas: the International Congress of Onomastic Sciences recognizes that it can aid the program further and in turn be aided by it, now therefore be it

Resolved: that the International Congress of Onomastic Sciences, assembled at Firenze, endorses the recommendation of the Group of Experts set forth in United Nations document E/3441, and be it further

Resolved: that the International Committee of Onomastic Sciences and the International Centre of Onomastics (Louvain) hold themselves ready to co-operate in such ways as may be found appropriate with any body set up by the United Nations to promote international standardization of geographic names, and be it further

Resolved: that the International Congress of Onomastic Sciences commends to its members, to toponymists everywhere, and to governments, the aforesaid document for study and implementation, and be it further

Resolved: that the Economic and Social Council be urged to publish the report in such form as will make it readily available to toponymists as well as to others concerned.

ANNEX III

Resolution adopted by the Economic and Social Council

814 (XXXI). INTERNATIONAL CO-OPERATION IN THE STANDARDIZATION OF GEOGRAPHICAL NAMES

The Economic and Social Council,

Having considered the report of the Group of Experts on Geographical Names^a,

Recognizing the continuing need for international co-operation in the standardization of geographical names and noting the recommendations contained in the report,

1. *Commends* the Group of Experts on Geographical Names for an excellent report on a complex problem;

2. *Recommends* that the Governments of Member States:

(a) Adopt as appropriate the recommendations of the Group of Experts and take steps for their implementation;

(b) Give emphasis to field investigation and checking with local authorities in standardizing place names, to the determination of the accurate latitude and longitude of these places and to showing them on maps;

(c) Transmit to the Secretary-General information on the progress being made in the standardization of geographical names, copies of gazetteers, maps and information concerning technical procedures being used in the standardization of domestic names, information on the techniques and systems used in the transliteration

^a E/3441 and Corr. 1.

tion of names of other countries, and as appropriate their comments on the report of the Group of Experts;

3. *Requests* the Secretary-General:

(a) To publish the report of the Group of Experts in the series entitled *World Cartography*;

(b) To provide clearing-house functions for collecting information on the standardization of geographical names being carried out by Member States and for periodically supplying Member States with information on the material received and on where it may be obtained;

(c) To assist Governments of Member States, when requested, in the establishment of national organizations for standardizing geographical names and in the solution of specific problems concerning geographical names, calling upon experts in the practical application of nomenclature when desirable;

(d) To assist, when requested, in the creation of working groups of representatives from countries using the same linguistic system;

(e) To report to the Council within two years on the progress being made by the Governments of Member States in the domestic standardization of geographical names and on the desirability of convening an international conference on this question.

ANNEX IV

PAIGH Working Group—Geographic dictionary and geographic name standardization

PLAN OF WORK—GEOGRAPHIC NAME STANDARDIZATION

Before the Consultation:

Circulate copies of the ECOSOC report;

Review the existing gazetteers and/or name lists, such as censuses, of each Member State, with particular attention to coverage and methods of preparation.

At the Consultation:

Discuss the ECOSOC report and its applicability in each of the Member States, or group of States;

Based on reviews of existing name lists or gazetteers, assess the size and nature of the project in each Member State, or group of States;

Agree on intercommunication methods and kinds of information to be exchanged;

Explore the kind and amount of linguistic assistance needed and available, and where and how additional help may be obtained;

Prepare a statement of agreed-upon procedures and recommendations, including recommendations on the post-Consultation plan of work;

After the Consultation:

Take up basic policy decisions called for by the ECOSOC report in each Member State where this has not already been done;

Initiate, or extend, basic record files on individual geographic names in each Member State.

HOW TO OBTAIN UNITED NATIONS PUBLICATIONS

United Nations publications may be obtained from bookstores and distributors throughout the world. Consult your bookstore or write to: United Nations, Sales Section, New York or Geneva.

COMMENT SE PROCURER LES PUBLICATIONS DES NATIONS UNIES

Les publications des Nations Unies sont en vente dans les librairies et les agences dépositaires du monde entier. Informez-vous auprès de votre librairie ou adressez-vous à: Nations Unies, Section des ventes, New York ou Genève.

COMO CONSEGUIR PUBLICACIONES DE LAS NACIONES UNIDAS

Las publicaciones de las Naciones Unidas están en venta en librerías y casas distribuidoras en todas partes del mundo. Consulte a su librero o diríjase a: Naciones Unidas, Sección de Ventas, Nueva York o Ginebra.